



TSM7401

20V N-Channel MOSFET w/ESD Protected

SOP-8



Pin assignment:

1. Source
2. Source
3. Source
4. Gate
- 5, 6, 7, 8. Drain

$V_{DS} = 20V$

$R_{DS(on)}, V_{GS} @ 4.5V, I_{DS} @ 4.5A = 20m\Omega$

$R_{DS(on)}, V_{GS} @ 2.7V, I_{DS} @ 3.5A = 25m\Omega$

Features

- ◇ Advanced trench process technology
- ◇ High density cell design for ultra low on-resistance
- ◇ Excellent thermal and electrical capabilities
- ◇ Specially designed for Li-ion battery packs.
- ◇ Battery switch application

Ordering Information

Part No.	Packing	Package
TSM7401CS	Tape & Reel 2,500/per reel	SOP-8

Block Diagram

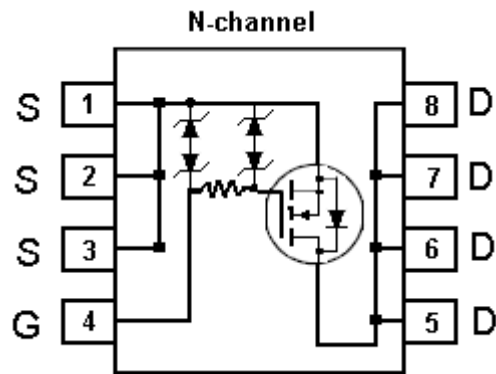

Absolute Maximum Rating (Ta = 25°C unless otherwise noted)

Parameter	Symbol	Limit	Unit	
Drain-Source Voltage	V_{DS}	20V	V	
Gate-Source Voltage	V_{GS}	± 12	V	
Continuous Drain Current, $V_{GS} @ 4.5V$.	I_D	8	A	
Pulsed Drain Current, $V_{GS} @ 4.5V$	I_{DM}	30	A	
Maximum Power Dissipation	P_D	Ta = 25°C	2.5	W
		Ta = 70°C	1.3	
Operating Junction Temperature	T_J	+150	°C	
Operating Junction and Storage Temperature Range	T_J, T_{STG}	- 55 to +150	°C	

Thermal Performance

Parameter	Symbol	Limit	Unit
Junction to Foot (Drain) Thermal Resistance	$R_{\theta Jf}$	30	°C/W
Junction to Ambient Thermal Resistance (PCB mounted)	$R_{\theta Ja}$	50	°C/W

Note: Surface mounted on FR4 board $t \leq 10$ sec.

Electrical Characteristics						
(Ta = 25 °C unless otherwise noted)						
Parameter	Conditions	Symbol	Min	Typ	Max	Unit
Static						
Drain-Source Breakdown Voltage	$V_{GS} = 0V, I_D = 250\mu A$	BV_{DSS}	20	--	--	V
Drain-Source On-State Resistance	$V_{GS} = 4.5V, I_D = 4.5A$	$R_{DS(ON)}$	--	20	25	mΩ
Drain-Source On-State Resistance	$V_{GS} = 2.7V, I_D = 3.5A$	$R_{DS(ON)}$	--	25	30	
Gate Threshold Voltage	$V_{DS} = V_{GS}, I_D = 250\mu A$	$V_{GS(TH)}$	0.65	0.85	--	V
Zero Gate Voltage Drain Current	$V_{DS} = 20V, V_{GS} = 0V$	I_{DSS}	--	--	1.0	μA
Gate Body Leakage	$V_{GS} = \pm 4.5V, V_{DS} = 0V$	I_{GSS}	--	--	± 100	nA
On-State Drain Current	$V_{GS} = 4.5V, V_{DS} \geq 5V$	$I_{D(ON)}$	30	--	--	A
Forward Transconductance	$V_{DS} = 10V, I_D = 4.5A$	g_{fs}	--	30	--	S
Dynamic						
Total Gate Charge	$V_{DS} = 10V, I_D = 4.5A,$ $V_{GS} = 4.5V$	Q_g	--	15.5	35	nC
Gate-Source Charge		Q_{gs}	--	3	--	
Gate-Drain Charge		Q_{gd}	--	5	--	
Turn-On Delay Time	$V_{DD} = 10V, R_L = 10\Omega,$ $I_D = 1A, V_{GEN} = 4.5V,$ $R_G = 6\Omega$	$t_{d(on)}$	--	75	100	nS
Turn-On Rise Time		t_r	--	125	150	
Turn-Off Delay Time		$t_{d(off)}$	--	600	720	
Turn-Off Fall Time		t_f	--	300	360	
Input Capacitance	$V_{DS} = 10V, V_{GS} = 0V,$ $f = 1.0MHz$	C_{iss}	--	1336	--	pF
Output Capacitance		C_{oss}	--	220	--	
Reverse Transfer Capacitance		C_{rss}	--	130	--	
Source-Drain Diode						
Max. Diode Forward Current		I_S	--	--	2.0	A
Diode Forward Voltage	$I_S = 2.0A, V_{GS} = 0V$	V_{SD}	--	0.6	1.2	V

Note : pulse test: pulse width $\leq 300\mu s$, duty cycle $\leq 2\%$

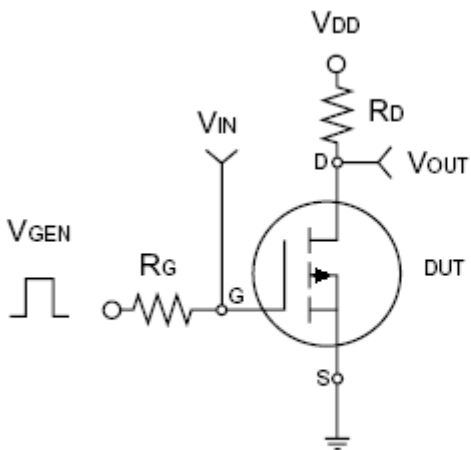

Switching Test Circuit

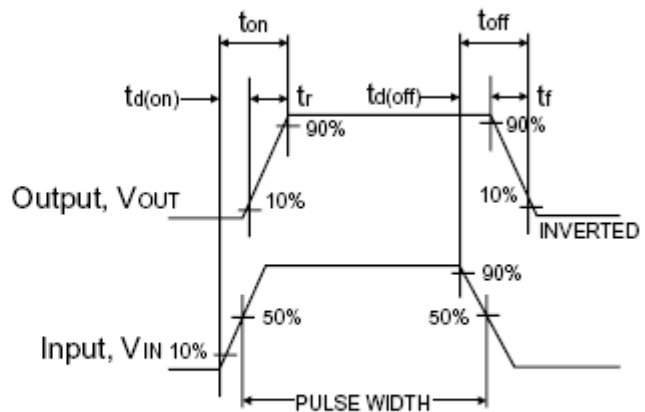

Switchin Waveforms

Typical Characteristics Curve ($T_a = 25^\circ\text{C}$ unless otherwise noted)

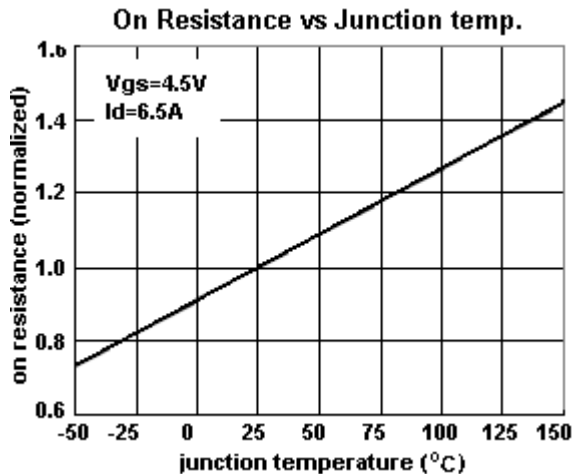
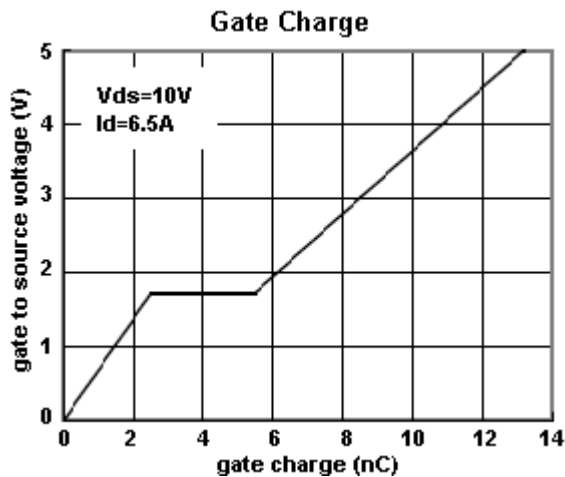
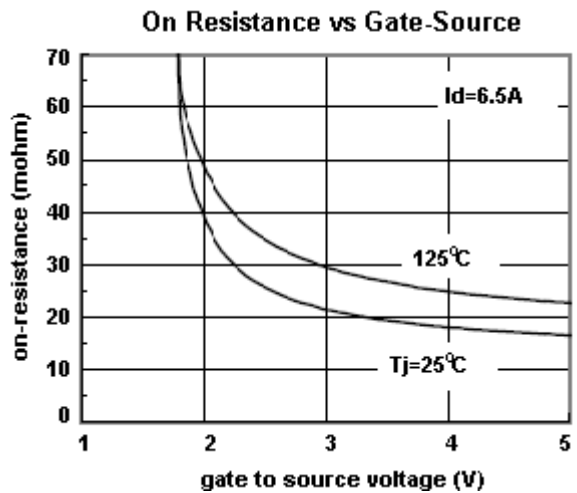
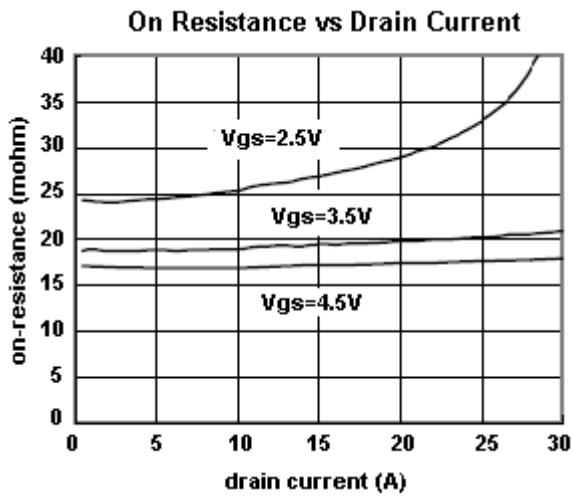
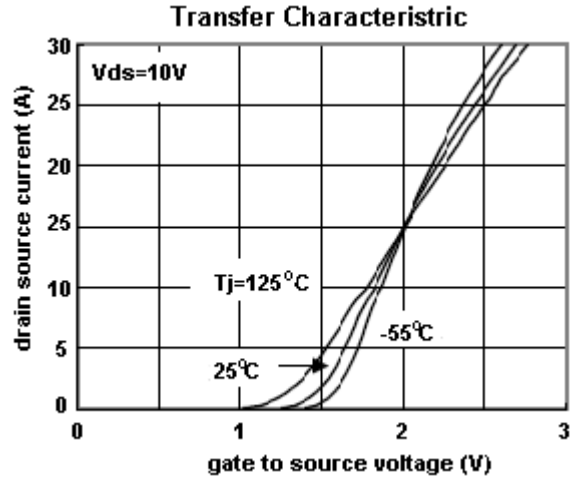
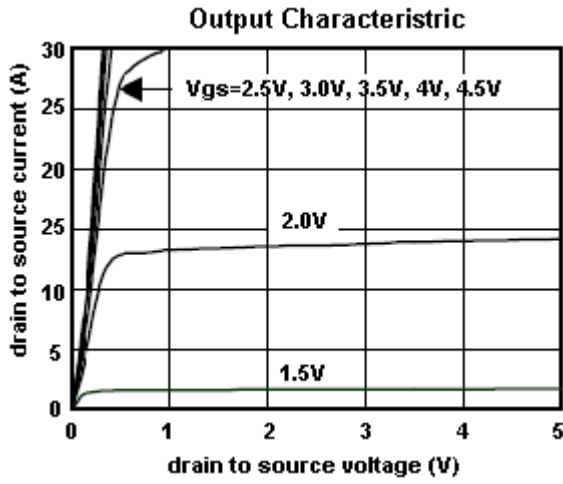

Electrical Characteristics Curve (continued)

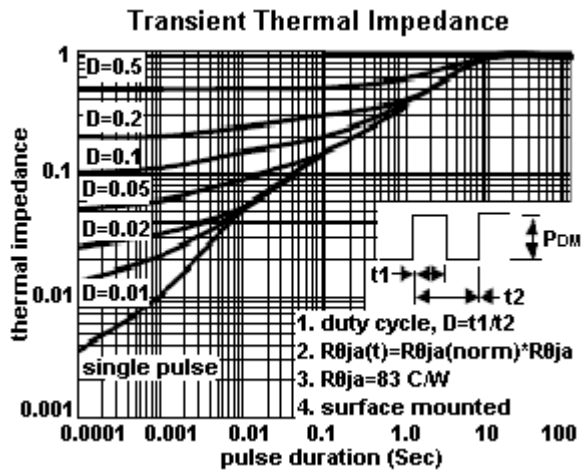
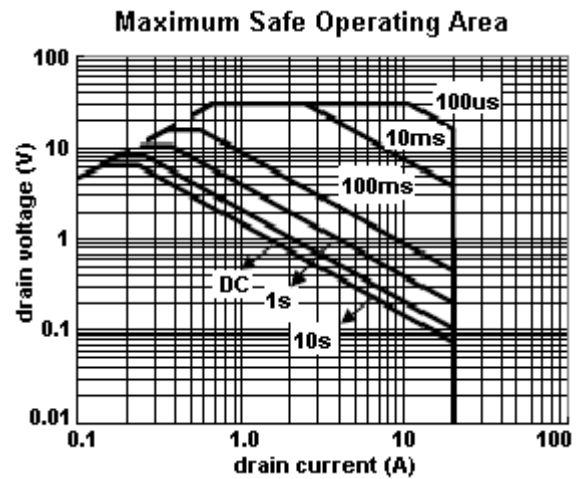
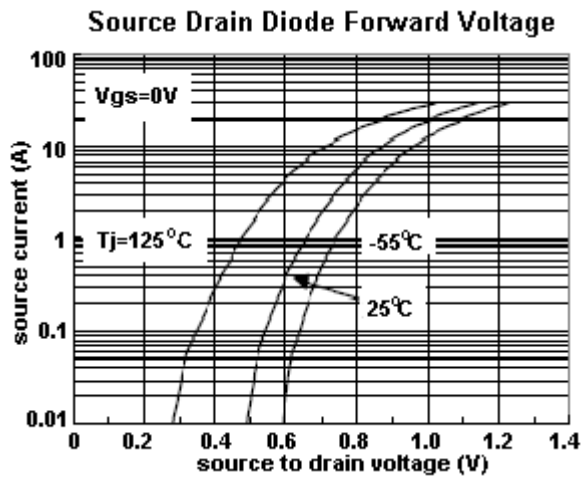
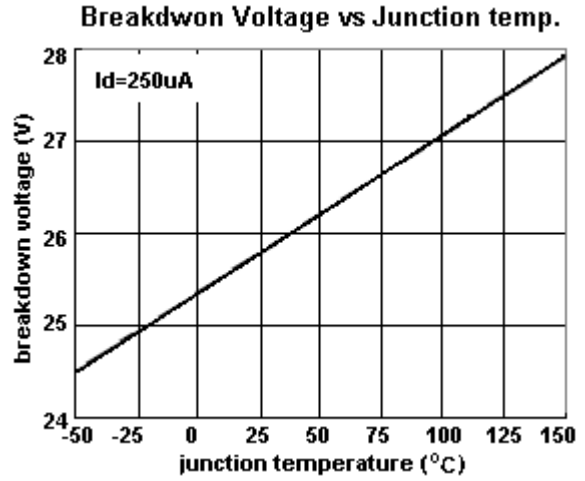
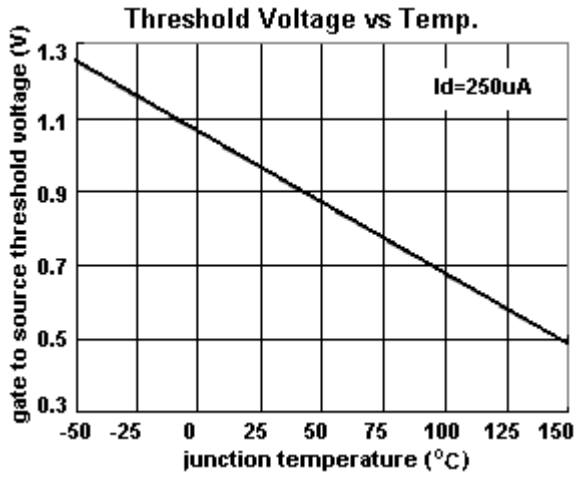

SOP-8 Mechanical Drawing

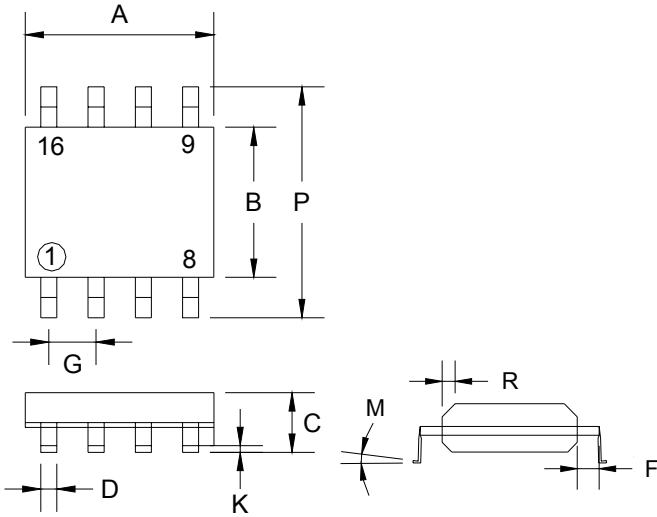

SOP-8 DIMENSION				
DIM	MILLIMETERS		INCHES	
	MIN	MAX	MIN	MAX
A	4.80	5.00	0.189	0.196
B	3.80	4.00	0.150	0.157
C	1.35	1.75	0.054	0.068
D	0.35	0.49	0.014	0.019
F	0.40	1.25	0.016	0.049
G	1.27 (typ)		0.05 (typ)	
K	0.10	0.25	0.004	0.009
M	0°	7°	0°	7°
P	5.80	6.20	0.229	0.244
R	0.25	0.50	0.010	0.019