

KA5P0680C

Fairchild Power Switch(FPS)

Features

- Adjustable switching frequency
- Intelligent Power Saving mode
- Pulse by pulse current limiting
- Over current Latch protection
- Over voltage protection
- Internal thermal shutdown function
- Built-in Soft Start function
- Internal high voltage sense FET
- Auto-restart mode

Description

The Fairchild Power Switch(FPS) product family is specially designed for an off-line SMPS with minimal external components. The Fairchild Power Switch(FPS) consist of high voltage power SenseFET and current mode PWM IC. Included PWM controller features integrated fixed oscillator, under voltage lock out, leading edge blanking, optimized gate turn-on/turn-off driver, thermal shut down protection, over voltage protection, and temperature compensated precision current sources for loop compensation and fault protection circuitry. compared to discrete MOSFET and controller or RCC switching converter solution, a Fairchild Power Switch(FPS) can reduce total component count, design size, and weight and at the same time increase efficiency, productivity, and system reliability. It has a basic platform well suited for cost effective design in PC SMPS with Power Saving function.

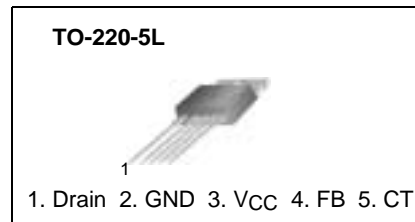

Internal Block Diagram

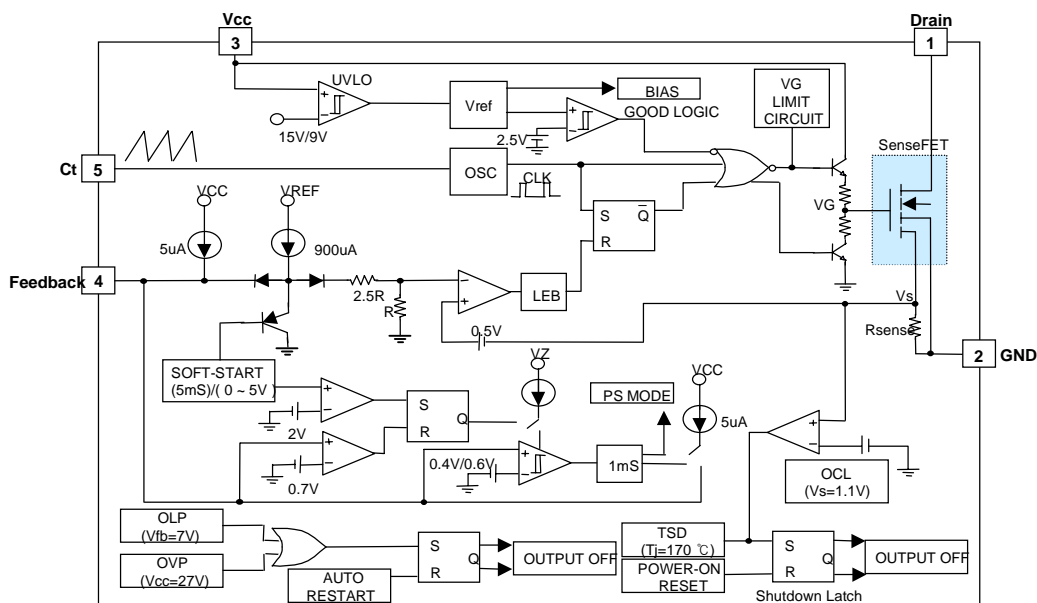

Absolute Maximum Ratings

(Ta=25°C, unless otherwise specified)

Parameter	Symbol	Value	Unit
Maximum Drain voltage ⁽¹⁾	V _{D,MAX}	800	V
Drain-Gate voltage (R _{GS} =1MΩ)	V _{DGR}	800	V
Gate-source (GND) voltage	V _{GS}	±30	V
Drain current pulsed ⁽²⁾	I _{DM}	24.0	ADC
Single pulsed avalanche energy ⁽³⁾	E _{AS}	455	mJ
Avalanche current ⁽⁴⁾	I _{AS}	27	A
Continuous drain current (T _C =25°C)	I _D	6.0	ADC
Continuous drain current (T _C =100°C)	I _D	4.0	ADC
Maximum Supply voltage	V _{CC,MAX}	30	V
Input voltage range	V _{FBI}	-0.3 to 7V	V
Total power dissipation	P _D	150	W
	Derating	1.21	W/°C
Operating ambient temperature	T _A	-25 to +85	°C
Storage temperature	T _{STG}	-55 to +150	°C

Notes:

1. T_j=25°C to 150°C
2. Repetitive rating: Pulse width limited by maximum junction temperature
3. L=24mH, starting T_j=25°C
4. L=13μH, starting T_j=25°C

Electrical Characteristics (SFET part)

(Ta=25°C unless otherwise specified)

Parameter	Symbol	Condition	Min.	Typ.	Max.	Unit
Drain to PKG Breakdown voltage	BV _{PKG}	60Hz AC, Ta=25°C	3500	-	-	V
Drain-source breakdown voltage	BV _{DSS}	V _{GS} =0V, I _D =50μA	800	-	-	V
Zero gate voltage drain current	I _{DSS}	V _{DS} =Max., Rating, V _{GS} =0V	-	-	50	μA
		V _{DS} =0.8Max., Rating, V _{GS} =0V, T _C =125°C	-	-	200	μA
Static drain-source on resistance ^(note)	R _{DS(ON)}	V _{GS} =10V, I _D =4.0A	-	1.6	2.0	Ω
Forward transconductance ^(note)	g _{fs}	V _{DS} =15V, I _D =4.0A	1.5	2.5	-	S
Input capacitance	C _{iss}	V _{GS} =0V, V _{DS} =25V, f=1MHz	-	1600	-	pF
Output capacitance	C _{oss}		-	140	-	
Reverse transfer capacitance	C _{rss}		-	42	-	
Turn on delay time	td(on)	V _{DD} =0.5BV _{DSS} , I _D =7.0A (MOSFET switching time are essentially independent of operating temperature)	-	60	-	nS
Rise time	tr		-	150	-	
Turn off delay time	td(off)		-	300	-	
Fall time	tf		-	130	-	
Total gate charge (gate-source+gate-drain)	Q _g	V _{GS} =10V, I _D =7.0A, V _{DS} =0.5BV _{DSS} (MOSFET switching time are essentially independent of operating temperature)	-	70	-	nC
Gate-source charge	Q _{gs}		-	16	-	
Gate-drain (Miller) charge	Q _{gd}		-	27	-	

Note:

Pulse test: Pulse width ≤ 300μs, duty ≤ 2%

$$S = \frac{1}{R}$$

Electrical Characteristics (Control part)

(Ta=25°C unless otherwise specified)

Parameter	Symbol	Test Condition	Min.	Typ.	Max.	Unit
UVLO SECTION						
Start Threshold Voltage	VSTART	-	14	15	16	V
Min. Operating Voltage After Turn On	VSTOP	-	8.4	9	9.6	V
OSCILLATOR SECTION						
Initial Frequency	FOSC	CT=2n	61	67	73	KHz
Temperature Stability (note 1)	ΔFOSC	-25°C ≤ Ta ≤ 85°C	0	±5	±10	%
Maximum Duty Cycle	DMAX	RT=21kΩ	85	88	91	%
Offset Voltage	Voffset	-	0.5	0.55	0.6	%
FEEDBACK SECTION						
Feedback Source Current	IFB	Vsc = 0V	0.9	1.1	1.3	mA
Shutdown Feedback Voltage	Vsd	Vfb ≥ 6V	6.3	6.9	7.5	V
Shutdown Delay Current	IDELAY	4V ≤ Vfb ≤ Vsd	4	5	6	μA
CURRENT LIMIT (SELF-PROTECTION) SECTION						
Peak Current Limit	I _{OVER}	Max. inductor current	3.52	4	4.48	A
PROTECTION SECTION						
Over Voltage Protection	VOVP	Vcc ≥ 22V	25	27	29	V
Thermal Shutdown Temp.	TSD	-	150	170	-	°C
POWER-SAVING MODE SECTION						
Power-saving Mode Feedback Volt.	V _{F(PS)}	VCC=16V	0.3	0.4	0.5	V
Power-saving Reset Feedback Volt.	V _{F(RE)}	VCC=16V	0.5	0.6	0.7	V
Power-saving Current	I _{PS}	VCC=16V	-	0.3	0.4	mA
Power-saving Mode Fb Current	I _{pfb}	VCC=16V	3	4	5	uA
TOTAL DEVICE SECTION						
Start Up Current	I _{start}	Vcc=14V	-	0.1	0.2	mA
Operating Supply Current	I _{OP}	Vcc ≤ 28V	-	10	18	mA

Note:

1. These parameters, although guaranteed, are not 100% tested in production

Typical Performance Characteristics

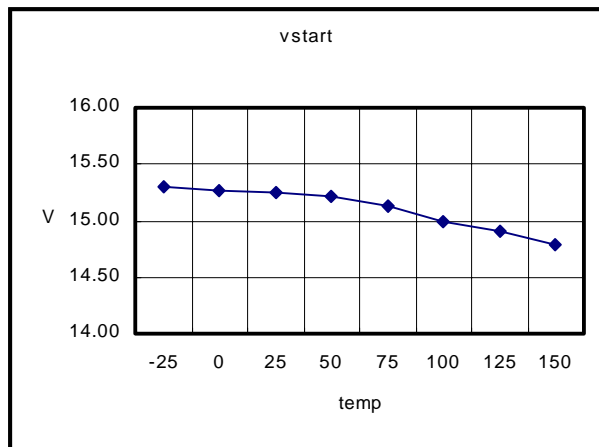

Figure 1. Start Threshold Voltage

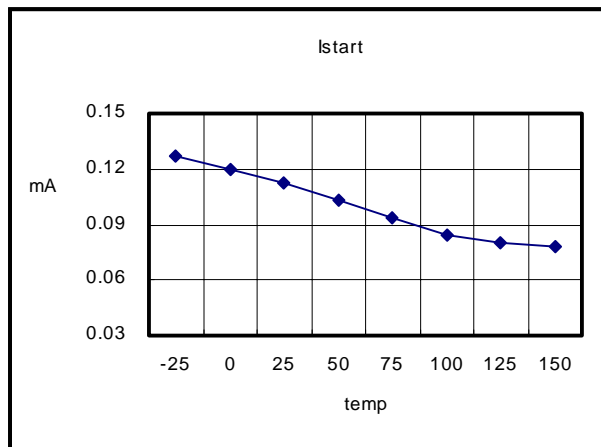

Figure 2. Stop Threshold Voltage

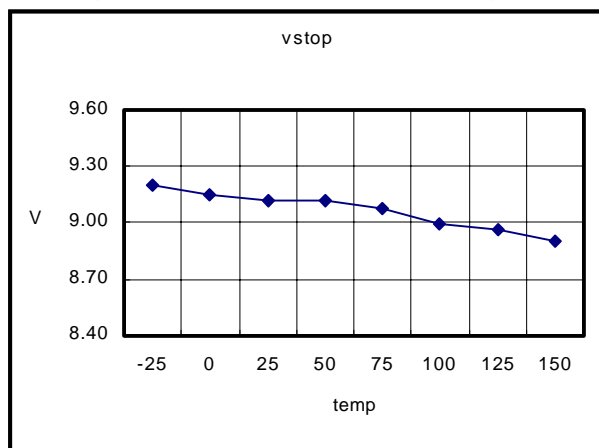

Figure 3. Start Up Current

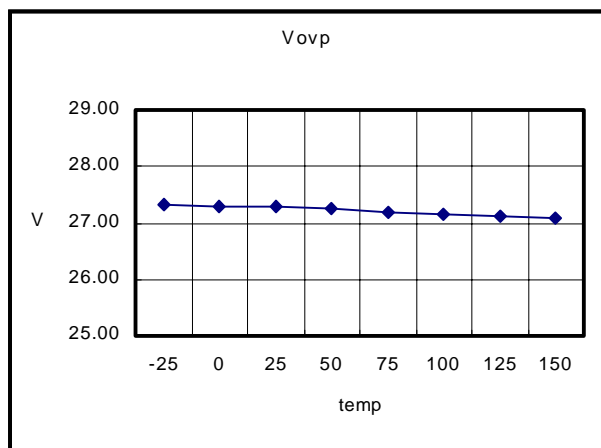

Figure 4. Over Voltage Protection

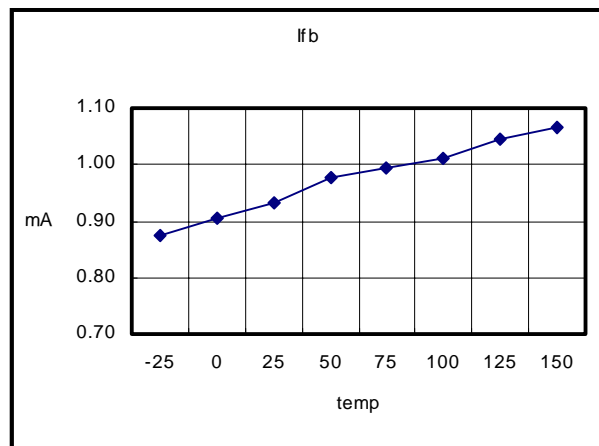

Figure 5. Feedback Source Current

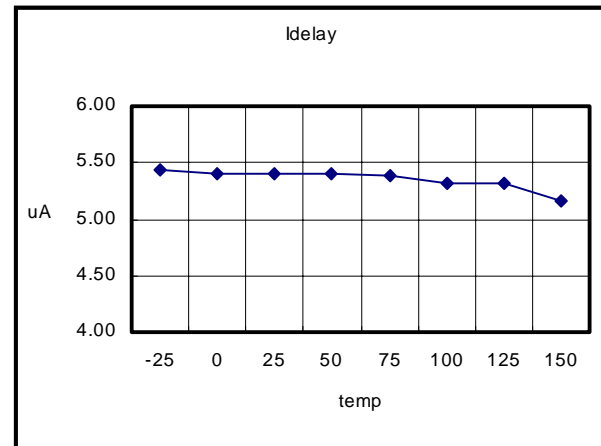

Figure 6. Shutdown Delay Current

Typical Performance Characteristics (Continued)

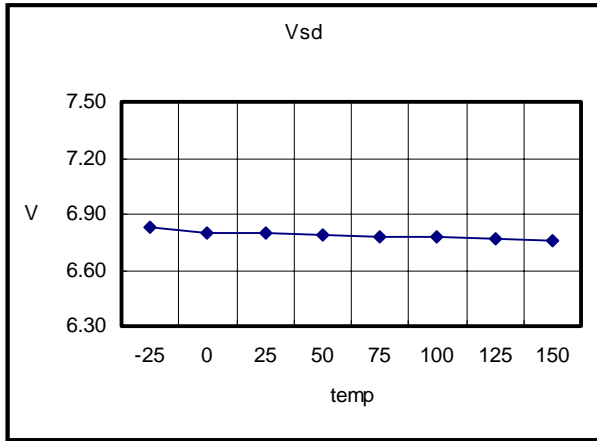

Figure 7. Shutdown Feedback Voltage

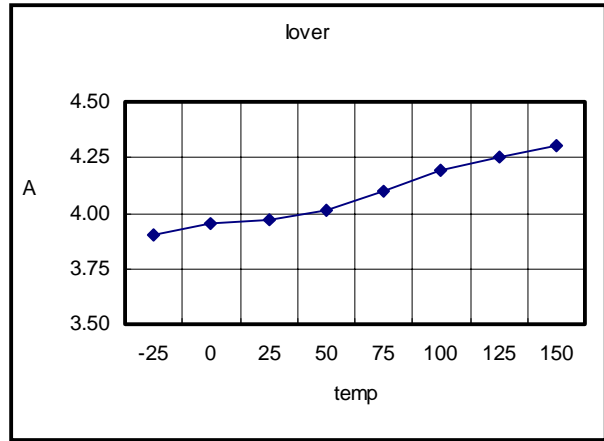

Figure 9. Peak Current Limit

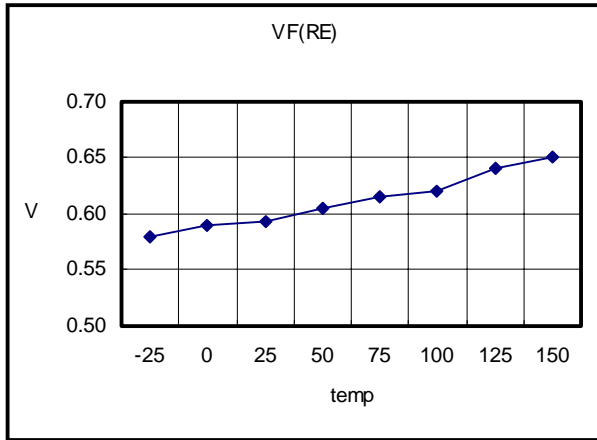

Figure 9. Power-Saving Reset Feedback Voltage

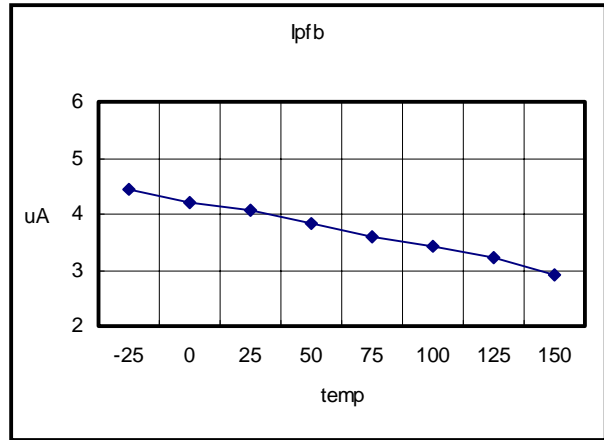

Figure 10. Power-Saving Mode Feedback Current

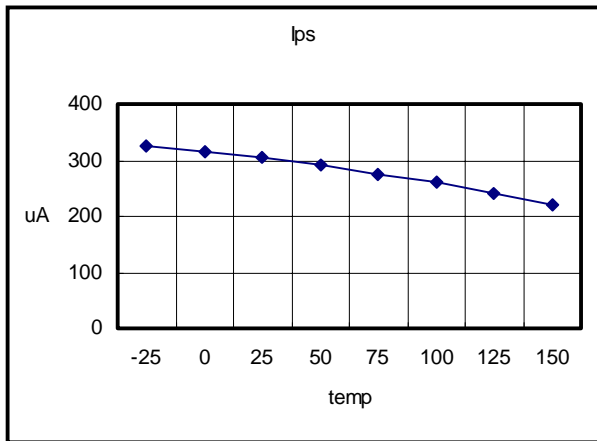

Figure 11. Power-Saving Current

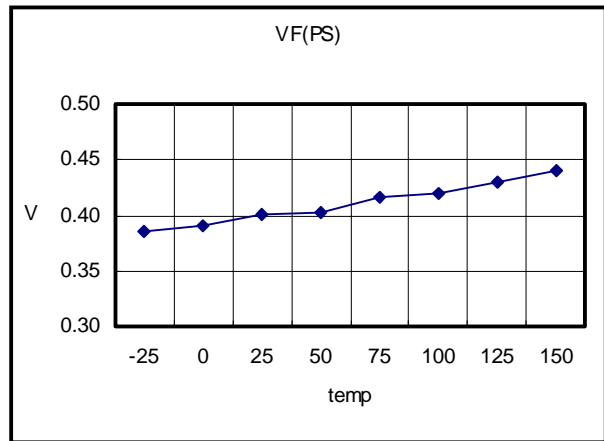

Figure 12. Power-Saving Mode Feedback Voltage

Typical Performance Characteristics (Continued)

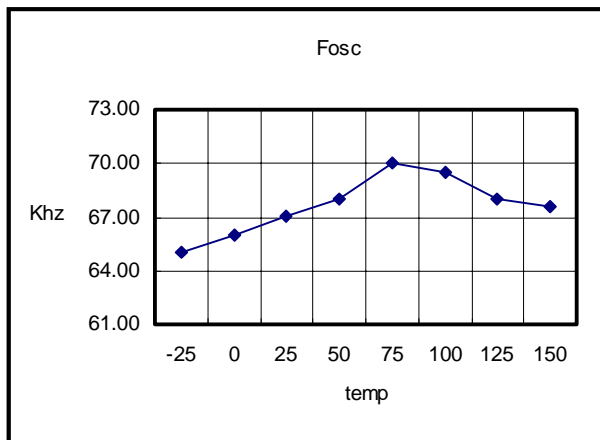

Figure 13. Operating Frequency

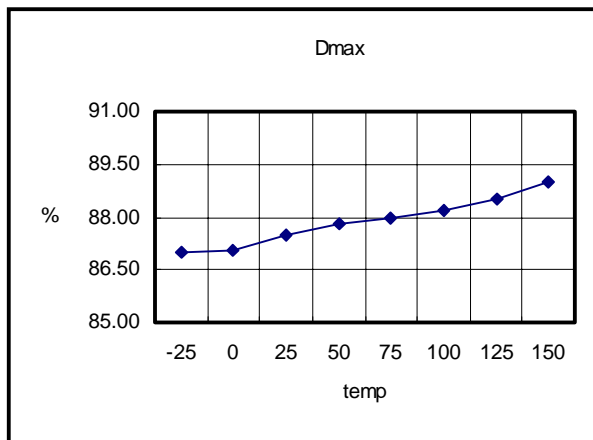
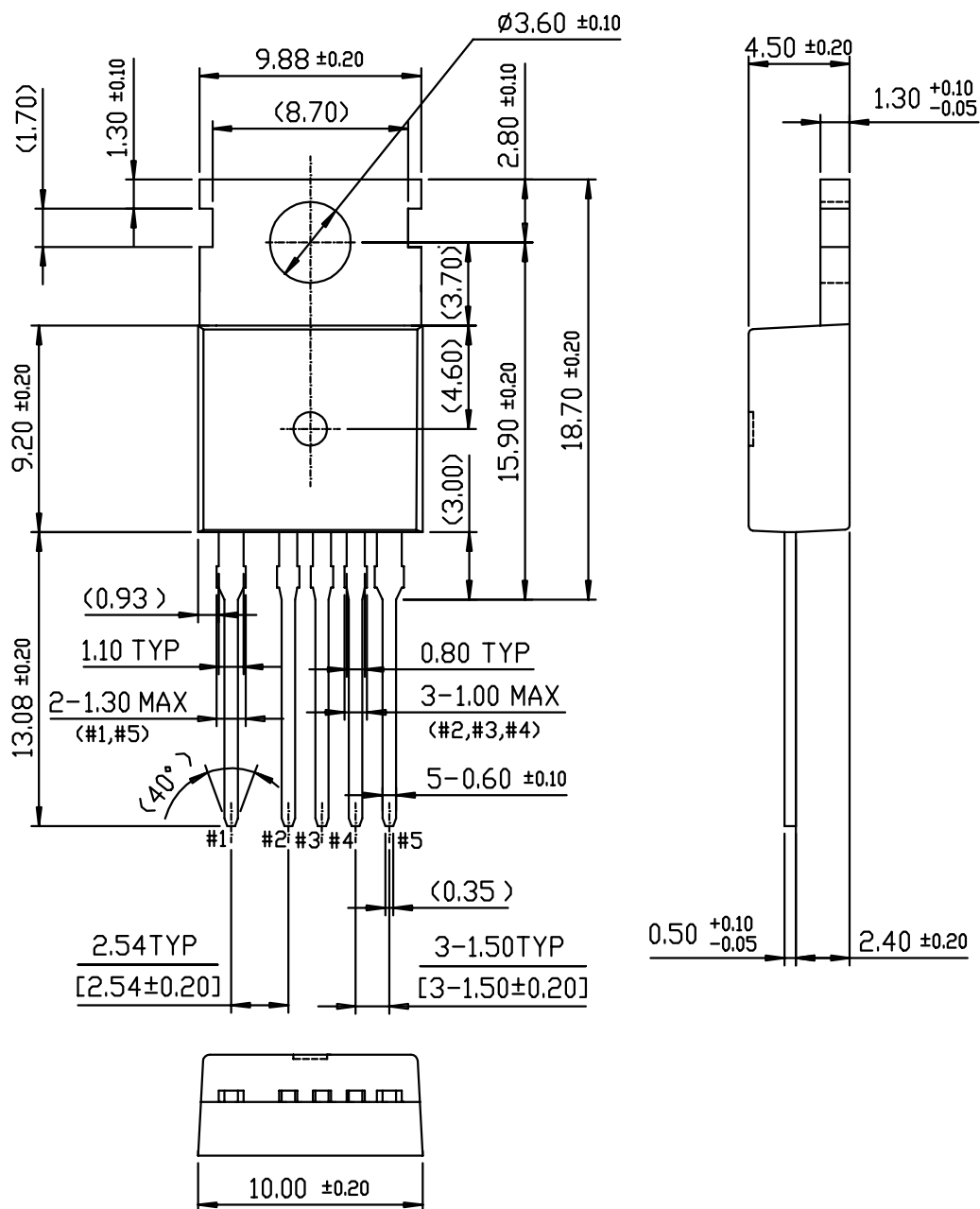

Figure 14. Maximum Duty Cycle

Package Dimensions

TO-220-5L



Package Dimensions (Continued)

TO-220-5L(Forming)

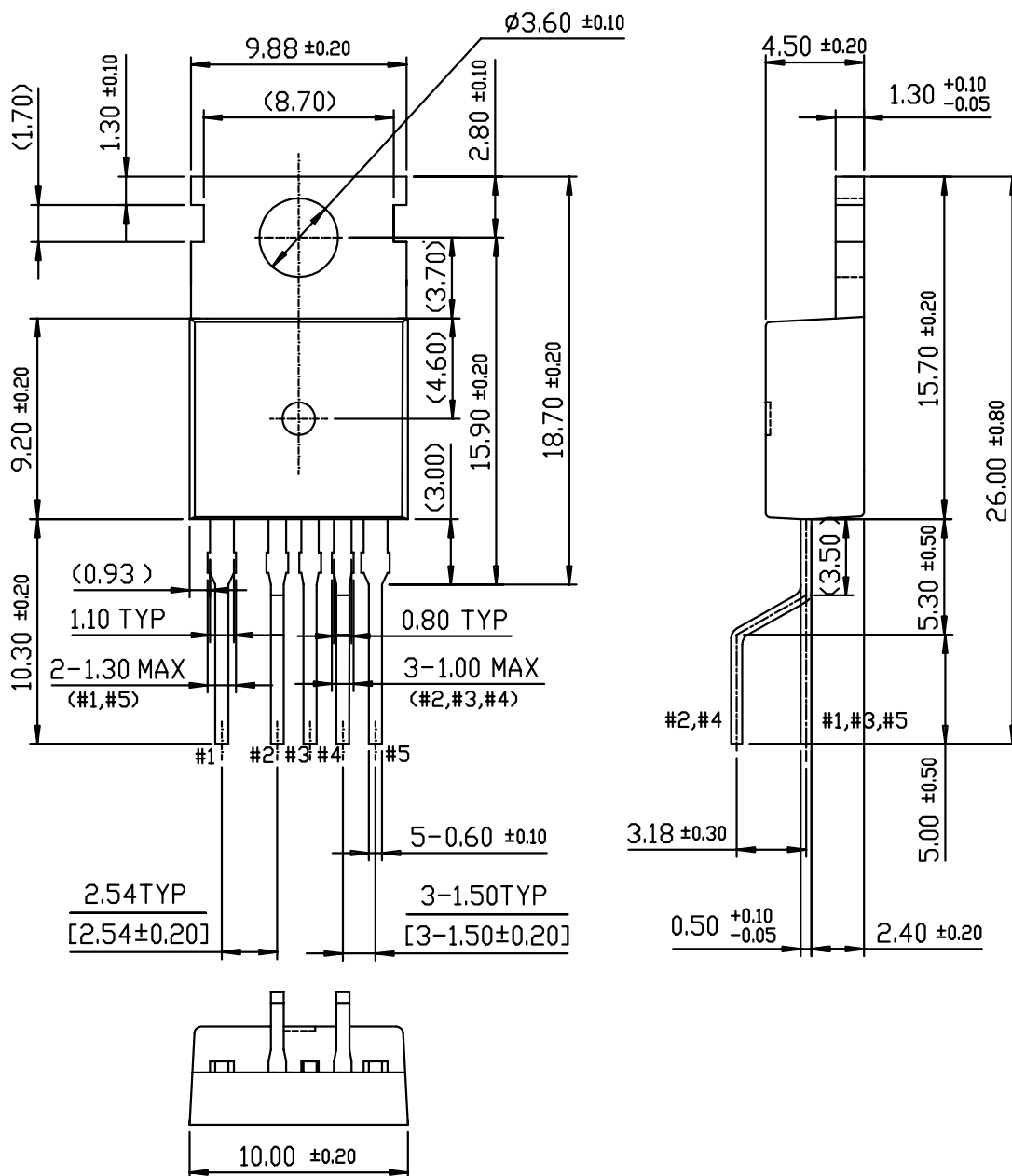

Ordering Information

Product Number	Package	Rating	Topr (°C)
KA5P0680C-TU	TO-220-5L	800V, 6A	-25°C to +85°C
KA5P0680C-YDTU	TO-220-5L(Forming)		

TU : Non Forming Type

YDTU : Forming Type

DISCLAIMER

FAIRCHILD SEMICONDUCTOR RESERVES THE RIGHT TO MAKE CHANGES WITHOUT FURTHER NOTICE TO ANY PRODUCTS HEREIN TO IMPROVE RELIABILITY, FUNCTION OR DESIGN. FAIRCHILD DOES NOT ASSUME ANY LIABILITY ARISING OUT OF THE APPLICATION OR USE OF ANY PRODUCT OR CIRCUIT DESCRIBED HEREIN; NEITHER DOES IT CONVEY ANY LICENSE UNDER ITS PATENT RIGHTS, NOR THE RIGHTS OF OTHERS.

LIFE SUPPORT POLICY

FAIRCHILD'S PRODUCTS ARE NOT AUTHORIZED FOR USE AS CRITICAL COMPONENTS IN LIFE SUPPORT DEVICES OR SYSTEMS WITHOUT THE EXPRESS WRITTEN APPROVAL OF THE PRESIDENT OF FAIRCHILD SEMICONDUCTOR CORPORATION. As used herein:

1. Life support devices or systems are devices or systems which, (a) are intended for surgical implant into the body, or (b) support or sustain life, and (c) whose failure to perform when properly used in accordance with instructions for use provided in the labeling, can be reasonably expected to result in a significant injury of the user.
2. A critical component in any component of a life support device or system whose failure to perform can be reasonably expected to cause the failure of the life support device or system, or to affect its safety or effectiveness.