

FEATURES

- Single +5 Volt Supply
- Automatic Gain Control
- -41 dBm Sensitivity
- 0 dBm Optical Overload
- 120 MHz Bandwidth

APPLICATIONS

- SONENT OC-3/SDH STM-1 (155 Mb/s) Receiver
- FDDI, Ethernet Fiber LAN
- Low Noise RF Amplifier

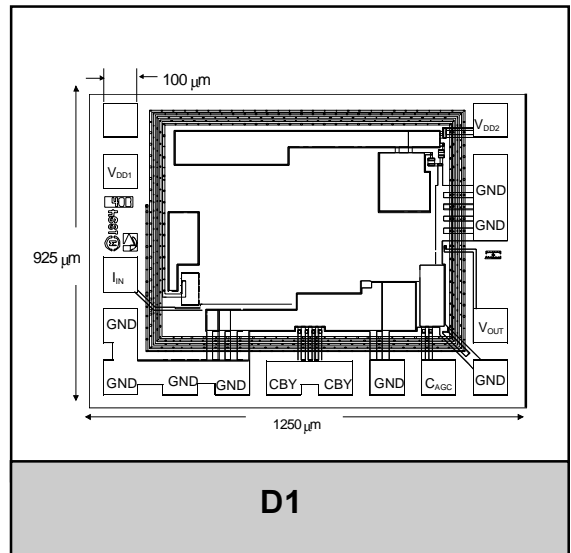

PRODUCT DESCRIPTION

The ANADIGICS ATA01502 is a 5V low noise transimpedance amplifier with AGC designed to be used in OC-3/STM-1 fiber optic links. The device is used in conjunction with a photodetector (PIN diode or avalanche photodiode) to convert an optical signal

into an output voltage. The ATA01502 offers a bandwidth of 120MHz and a dynamic range of 42dB. It is manufactured in a GaAs MESFET process and is available in bare die form.

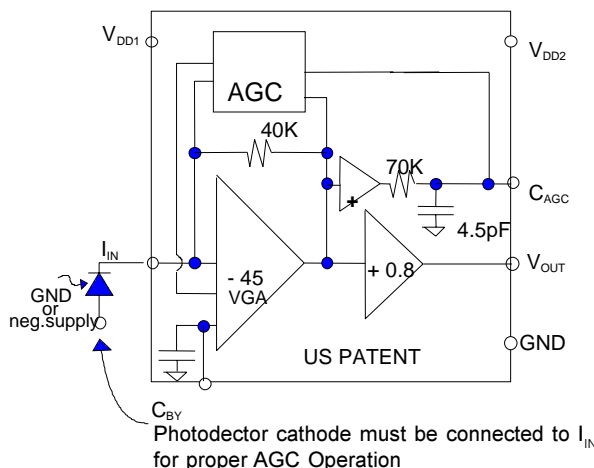

Figure 1: Equivalent Circuit

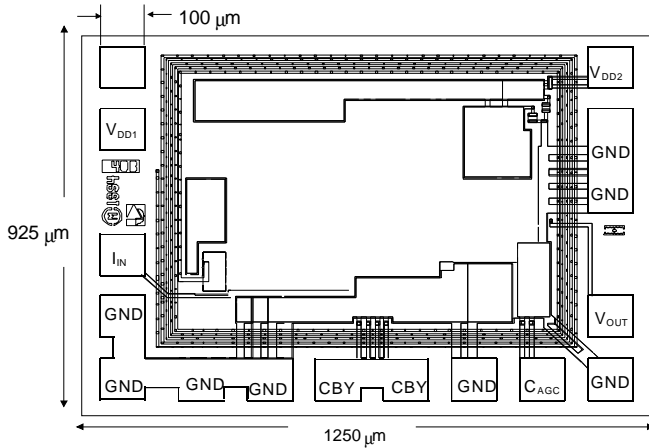

Figure 2: Bonding Pad Layout

Table 1: Pad Description

PAD	Description	Comment
V_{DD1}	V_{DD1}	Positive supply for input gain stage
V_{DD2}	V_{DD2}	Positive supply for second gain stage
I_{IN}	TIA Input Current	Connect detector cathode for proper operation
V_{OUT}	TIA Output Voltage	Requires external DC block
C_{AGC}	External AGC Capacitor	$70K^* (4.5p + CAGC) = AGC \text{ Time Constant}$
C_{BY}	Input Gain Stage Bypass Capacitor	$>56 \text{ pF}$

ELECTRICAL CHARACTERISTICS

Table 2: Absolute Maximum Ratings

V_{DD1}	7.0 V
V_{DD2}	7.0 V
I_{IN}	5 mA
T_A	Operating Temp. - 40 °C to 125 °C
T_S	Storage Temp. - 65 °C to 150 °C

Stresses in excess of the absolute ratings may cause permanent damage. Functional operation is not implied under these conditions. Exposure to absolute ratings for extended periods of time may adversely affect reliability.

Table 3: Electrical Specifications ⁽¹⁾

($T_A = 25^\circ\text{C}$, $V_{DD} = +5.0\text{V} \pm 10\%$, $C_{\text{DIODE}} + C_{\text{STRAY}} = 0.5 \text{ pF}$, Det. cathode to I_{IN})

PARAMETER	MIN	TYP	MAX	UNIT
Transresistance ($R_L = \infty, I_{\text{DC}} < 500\text{nA}$)	20	30		$\text{K}\Omega$
Transresistance ($R_L = 50\Omega$) ⁽¹⁾	9.5	13	10	$\text{K}\Omega$
Bandwidth -3dB	110	120		MHz
Input Resistance ⁽²⁾		1000		Ω
Output Resistance	30	50	60	Ω
Supply Current		30	45	mA
Input Offset Voltage	1.0	1.4		Volts
Output Offset Voltage		1.4		Volts
AGC Threshold (I_{IN}) ⁽³⁾		15		μA
Optical Overload ⁽⁴⁾	0	1		dBm
Input Noise Current ⁽⁵⁾		12		nA
AGC Time Constant ⁽⁶⁾		16		μsec
Offset Voltage Drift		1		mV/ $^\circ\text{C}$
Optical Sensitivity ⁽⁷⁾		-41		dBm
Operating Voltage Range	+ 4.5	+ 5.0	+ 6.0	Volts
Operating Temperature Range	- 40		85	$^\circ\text{C}$
Thermal Resistance		20		$^\circ\text{C}/\text{W}$

Notes:

- $f = 50\text{MHz}$
- Measured with I_{in} below AGC Threshold. During AGC, input impedance will decrease proportionally to I_{in} .
- Defined as the I_{in} where Transresistance has decreased by 50%.
- See note on "Indirect Measurement of Optical Overload."
- See note on "Measurement of Input Referred Noise Current."
- $C_{\text{AGC}} = 220 \text{ pF}$
- Parameter is guaranteed (not tested) by design and characterization data @155 Mb/s, assuming detector responsivity of 0.95.

APPLICATION INFORMATION

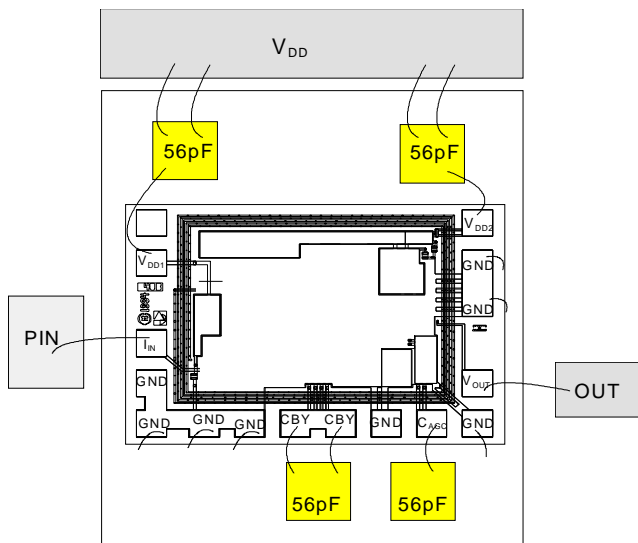

Figure 3: ATA 01502D1C Typical Bonding Diagram

Power Supplies and General Layout Considerations

The ATA01502D1C may be operated from a positive supply as low as + 4.5 V and as high as + 6.0 V. Below + 4.5 V, bandwidth, overload and sensitivity will degrade, while at + 6.0 V, bandwidth, overload and sensitivity improve (see "Bandwidth vs. Temperature" curves). Use of surface mount (preferably MIM type capacitors), low inductance power supply bypass capacitors ($\geq 56\text{pF}$) are essential for good high frequency and low noise performance. The power supply bypass capacitors should be mounted on or connected to a good low inductance ground plane.

General Layout Considerations

Since the gain stages of the transimpedance amplifier have an open loop bandwidth in excess of 1.0 GHz, it is essential to maintain good high frequency layout practices. To prevent oscillations, a low inductance RF ground plane should be made available for power supply bypassing. Traces that can be made short should be made short. The utmost care should be taken to maintain very low capacitance at the photodiode TIA interface (I_{IN}), as excess capacitance at this node will cause a degradation in

bandwidth and sensitivity (see Bandwidth vs. C_T curves).

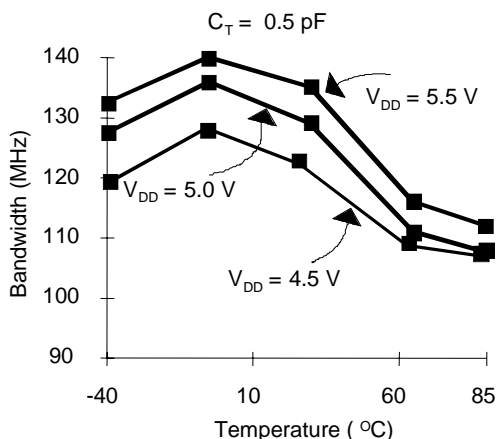

Figure 4: Bandwidth vs. Temperature

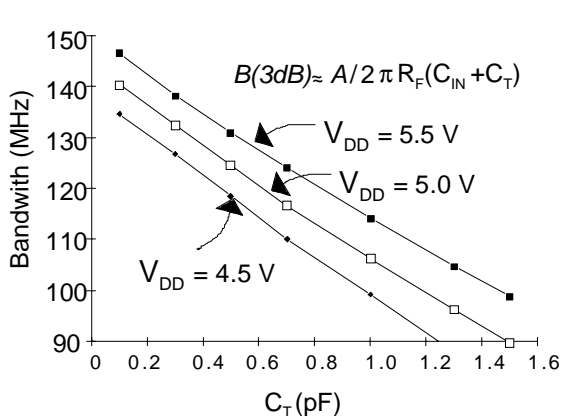

Figure 5: Bandwidth vs. CT

Note: All performance curves are typical @ $T_A = 25^\circ\text{C}$ unless otherwise noted.

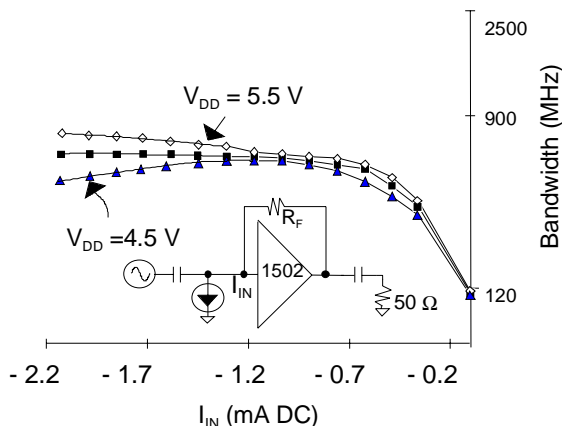

Figure 7: Bandwidth vs. I_{IN}

I_{IN} Connection

(Refer to the equivalent circuit diagram) Bonding the detector cathode to I_{IN} (and thus drawing current from the ATA01502D1C) improves the dynamic range. The detector may be used in the reverse direction for input currents not exceeding $13\ \mu\text{A}$, however the specifications for optical overload will not be met.

V_{OUT} Connection

The output pad should be connected via a coupling capacitor to the next stage of the receiver channel (filter or decision circuits), as the output buffers are not designed to drive a DC coupled 50 ohm load (this would require an output bias current of approximately 36 mA to maintain a quiescent 1.8 Volts across the output load). If V_{OUT} is connected to a high input impedance decision circuit ($>500\ \text{ohms}$), then a coupling capacitor may not be required, although caution should be exercised since DC offsets of the photo detector/TIA combination may cause clipping of subsequent gain or decision circuits.

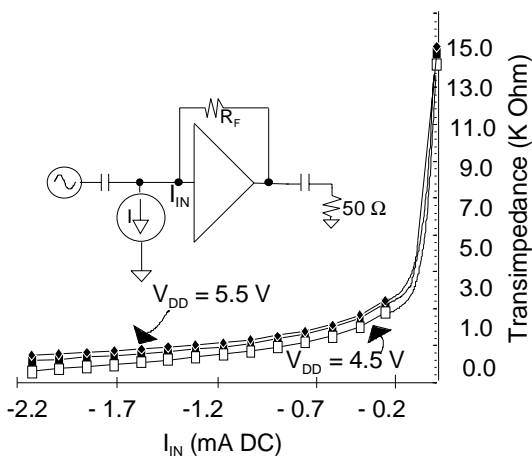

Figure 6: Transimpedance vs. I_{IN}

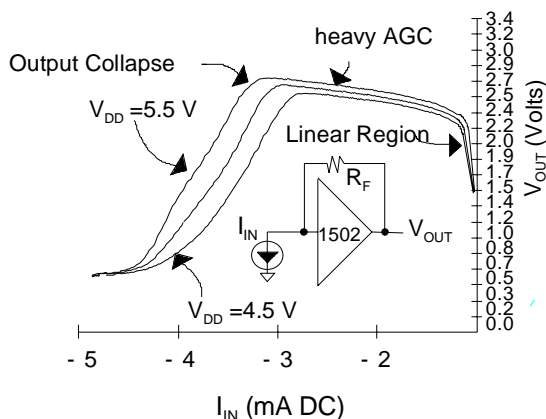

Figure 8: V_{OUT} vs. I_{IN}

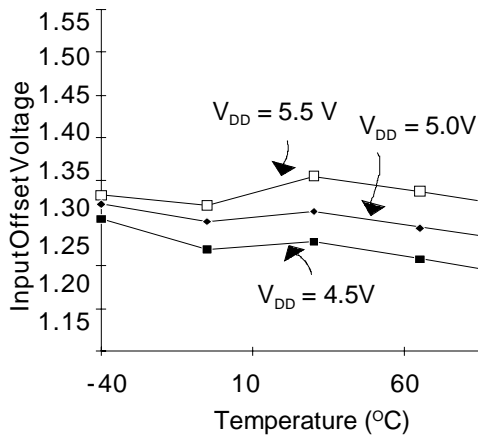

Figure 9: Input Offset Voltage vs. Temperature

C_{BY} Connection

The C_{BY} pad must be connected via a low inductance path to a surface mount capacitor of at least 56pF (additional capacitance can be added in parallel with the 56 pF or 220 pF capacitors to improve low frequency response and noise performance). Referring to the equivalent circuit diagram and the typical bonding diagram, it is critical that the connection from C_{BY} to the bypass capacitor use two bond wires for low inductance, since any high frequency impedance at this node will be fed back to the open loop amplifier with a resulting loss of transimpedance bandwidth. Two pads are provided for this purpose.

Sensitivity and Bandwidth

In order to guarantee sensitivity and bandwidth performance, the TIA is subjected to a comprehensive series of tests at the die sort level (100% testing at 25 °C) to verify the DC parametric performance and the high frequency performance (i.e. adequate |S21|) of the amplifier. Acceptably high |S21| of the internal gain stages will ensure low amplifier input capacitance and hence low input referred noise current. Transimpedance sensitivity and bandwidth are then guaranteed by design and correlation with RF and DC die sort test results. In applications that require - 41 dBm sensitivity, a low capacitance (< 0.5pF) and high responsivity (> 0.95) photodiode must be used.

Indirect Measurement of Optical Overload

Optical overload can be defined as the maximum optical power above, which the BER (bit error rate) increases beyond 1 error in 10¹⁰ bits. The ATA01502D1C is 100% tested at die sort by a DC measurement, which has excellent correlation with a PRBS optical overload measurement. The measurement consists of sinking a negative current (see V_{OUT} Vs I_{IN} figure) from the TIA and determining the point of output voltage collapse. In addition, the input node virtual ground during “heavy AGC” is checked to verify that the linearity (i.e. pulse width distortion) of the amplifier has not been compromised. As a final test, a DC transfer curve is performed on every die at the wafer level to ensure excellent overload performance.

Measurement of Input Referred Noise Current

The “Input Noise Current” is directly related to sensitivity. It can be defined as the output noise voltage (V_{OUT}), with no input signal, (including a 100 MHz lowpass filter at the output of the TIA) divided by the AC transresistance.

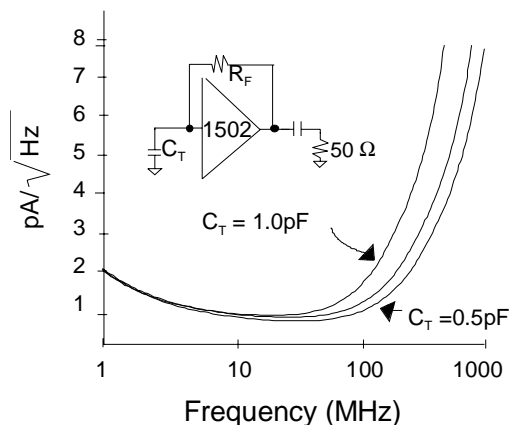

Figure 10: Input Referred Noise Spectral Density

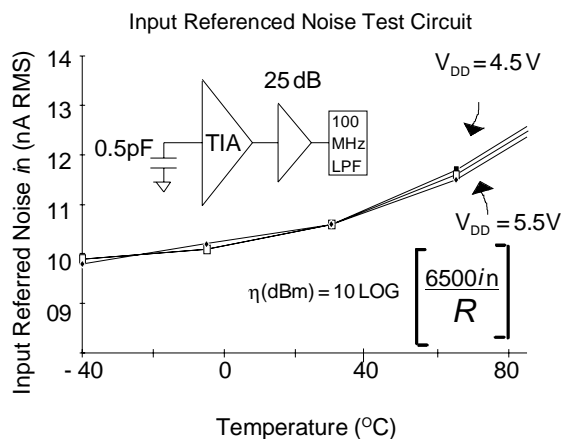
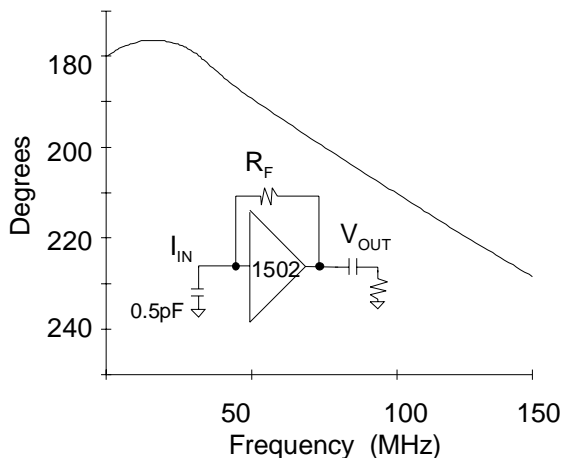

Figure 11: Input Referred Noise vs Temperature

Figure 12: Phase (I_{IN} to V_{OUT})

AGC Capacitor

It is important to select an external AGC capacitor of high quality and appropriate size. The ATA01502D1C has an on-chip 70 K Ω resistor with a shunt 4.5-pF capacitor to ground. Without external capacitance, the chip will provide an AGC time constant of 315 nS. For the best performance in a typical 155 MB/s SONET receiver, a minimum AGC capacitor of 56pF is recommended. This will provide the minimum amount of protection against pattern sensitivity and pulse width distortion on repetitive data sequences during high average optical power conditions. Conservative design practices should be followed when selecting an AGC capacitor, since unit to unit variability of the internal time constant and various data conditions can lead to data errors if the chosen value is too small.

Phase Response

At frequencies below the 3dB bandwidth of the device, the transimpedance phase response is characteristic of a single pole transfer function (as shown in the Phase Vs Frequency curve). The output impedance is essentially resistive up to 1000 MHz.

ORDERING INFORMATION

PART NUMBER	PACKAGE OPTION	PACKAGE DESCRIPTION
ATA01501D1C	D1C	Die



ANADIGICS, Inc.

141 Mount Bethel Road

Warren, New Jersey 07059, U.S.A

Tel: +1 (908) 668-5000

Fax: +1 (908) 668-5132

<http://www.anadigics.com>

Mktg@anadigics.com

IMPORTANT NOTICE

ANADIGICS, Inc. reserves the right to make changes to its products or to discontinue any product at any time without notice. The product specifications contained in Advanced Product Information sheets and Preliminary Data Sheets are subject to change prior to a product's formal introduction. Information in Data Sheets have been carefully checked and are assumed to be reliable; however, ANADIGICS assumes no responsibilities for inaccuracies. ANADIGICS strongly urges customers to verify that the information they are using is current before placing orders.

WARNING

ANADIGICS products are not intended for use in life support appliances, devices, or systems. Use of an ANADIGICS product in any such application without written consent is prohibited.