

FIBER OPTIC RECEIVING MODULE
TORX111

FIBER OPTIC RECEIVING MODULE FOR APF

Unit in mm

- Non-connector (connector less) type
- Data rate : DC to 6 Mb/s (NRZ code)
- Transmission distance :
Up to 10 m (With TOTX111)
- TTL interface

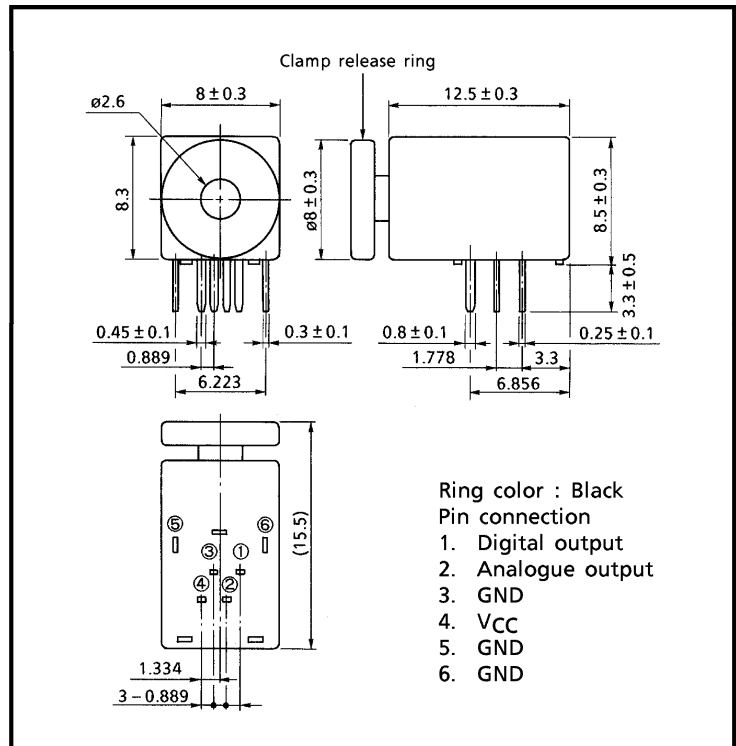

1. Maximum Ratings (Ta = 25°C)

PARAMETER	SYMBOL	RATINGS	UNIT
Storage Temperature	T _{stg}	-40 to 85	°C
Operating Temperature	T _{opr}	-20 to 70	°C
Supply Voltage	V _{CC}	-0.5 to 7	V
High Level Output Current	I _{OH}	-1	mA
Low Level Output Current	I _{OL}	20	mA
Clamped Fiber Bearable Force	F _{CB}	19.6 ⁽¹⁾	N
Soldering Temperature	T _{sol}	260 ⁽²⁾	°C

- Note ⁽¹⁾ Pulling in the axial direction. Momentary value.
⁽²⁾ Soldering time ≤ 3 s (More than 1 mm apart from the package).

961001EAA1

● TOSHIBA is continually working to improve the quality and the reliability of its products. Nevertheless, semiconductor devices in general can malfunction or fail due to their inherent electrical sensitivity and vulnerability to physical stress. It is the responsibility of the buyer, when utilizing TOSHIBA products, to observe standards of safety, and to avoid situations in which a malfunction or failure of a TOSHIBA product could cause loss of human life, bodily injury or damage to property. In developing your designs, please ensure that TOSHIBA products are used within specified operating ranges as set forth in the most recent products specifications. Also, please keep in mind the precautions and conditions set forth in the TOSHIBA Semiconductor Reliability Handbook.

● The information contained herein is presented only as a guide for the applications of our products. No responsibility is assumed by TOSHIBA CORPORATION for any infringements of intellectual property or other rights of the third parties which may result from its use. No license is granted by implication or otherwise under any intellectual property or other rights of TOSHIBA CORPORATION or others.

● The information contained herein is subject to change without notice.

2. Recommended Operating Conditions

PARAMETER	SYMBOL	MIN	TYP.	MAX	UNIT
Supply Voltage	V _{CC}	4.75	5.0	5.25	V
Load Impedance ⁽³⁾		—	—	10	kΩ
Load Capacitor ⁽³⁾		—	—	10	pF

⁽³⁾ Load of analogue output.

3. Electrical and Optical Characteristics (Ta = 25°C, V_{CC} = 5 V)

PARAMETER	SYMBOL	CONDITIONS	MIN	TYP.	MAX	UNIT
Data Rate		NRZ code ⁽⁴⁾	DC	—	6	Mb/s
Transmission Distance		APF ⁽⁵⁾ with TOTX111	0.2	—	10	m
Pulse Width Distortion ⁽⁶⁾	Δtw	Pulse width 165 ns Pulse cycle 330 ns C _L = 10 pF	−55	—	55	ns
Maximum Receivable Power ⁽⁷⁾	P _{MAX}	APF ⁽⁵⁾ , 6 Mb/s NRZ code	−4.5	—	—	dBm
Minimum Receivable Power ⁽⁷⁾	P _{MIN}	APF ⁽⁵⁾ , 6 Mb/s NRZ code	—	—	−22	dBm
Current Consumption	I _{CC}		—	12	20	mA
Analogue Output Voltage	V _A	P _{IN} = −4.5~−22 dBm	2.3	—	2.8	V
		P _{IN} = −∞ dBm	1.6	—	—	V
High Level Output Voltage	V _{OH}		4.0	—	—	V
Low Level Output Voltage	V _{OL}		—	—	0.4	V

⁽⁴⁾ When optical input is on, output level is high. Optical input is off, output is low.

⁽⁵⁾ All Plastic Fiber (980 μm core, 1000 μm cladding).

⁽⁶⁾ Between input of TOTX111 and digital output of TORX111.

⁽⁷⁾ BER ≤ 10^{−9}. Peak value.

4. Mechanical Characteristics (Ta = 25°C)

PARAMETER	SYMBOL	CONDITIONS	MIN	TYP.	MAX	UNIT
Fiber Insert Force	F _{FI}	Using TOFC100, First value	—	6	19.6	N
Fiber Clamping Force ⁽⁸⁾	F _{FC}	Using TOFC100, First value	19.6	35	—	N
Ring Unclamping Force ⁽⁹⁾	F _{RC}	Using TOFC100, First value	—	10	19.6	N

⁽⁸⁾ The optical fiber is disconnected when it is pulled with this load in the axial direction.

⁽⁹⁾ This is the load required for the clamp release ring to release the optical fiber clamp.
When disconnecting the optical fiber, hold in the clamp release ring.

5. Example of Typical Characteristics ⁽¹⁰⁾

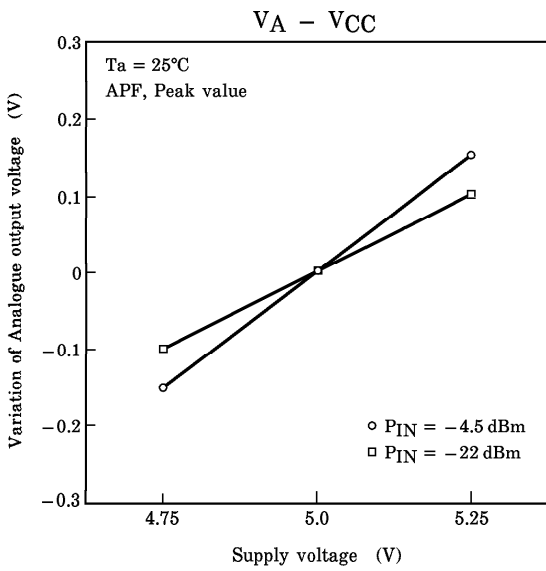
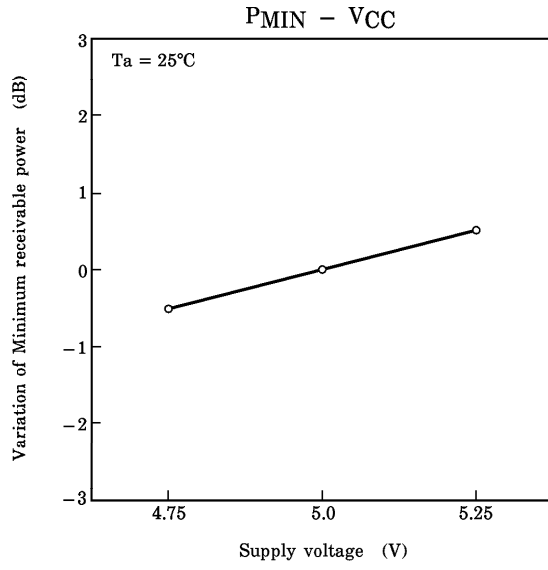
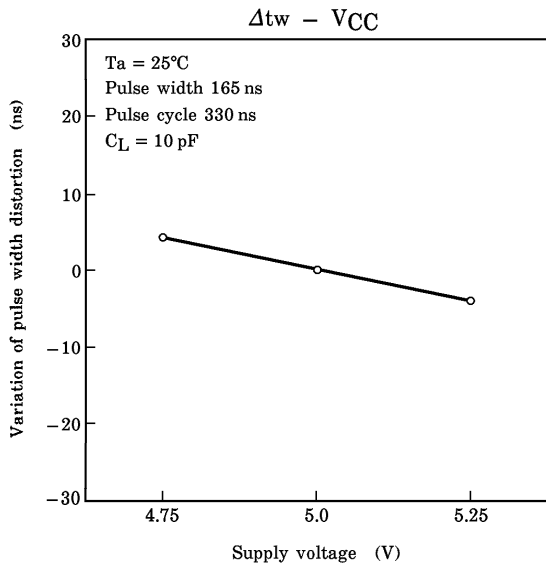

⁽¹⁰⁾ There give characteristic examples, and its values are not guaranteed.

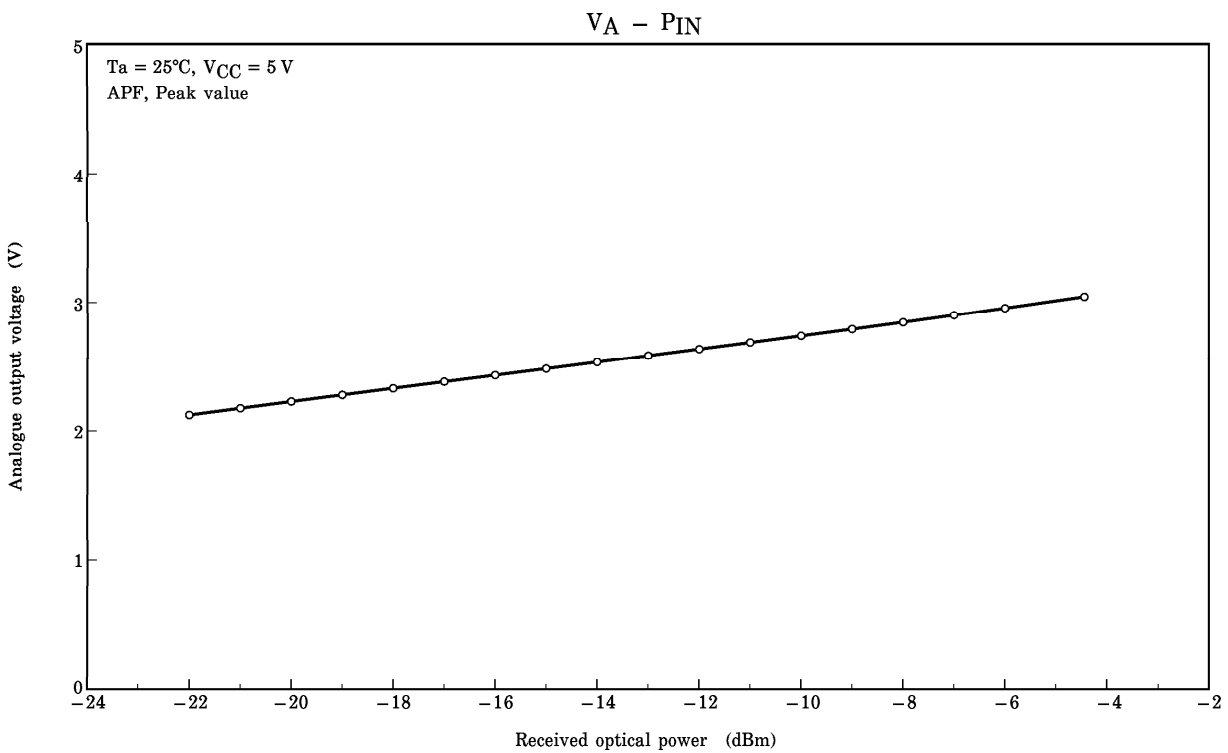
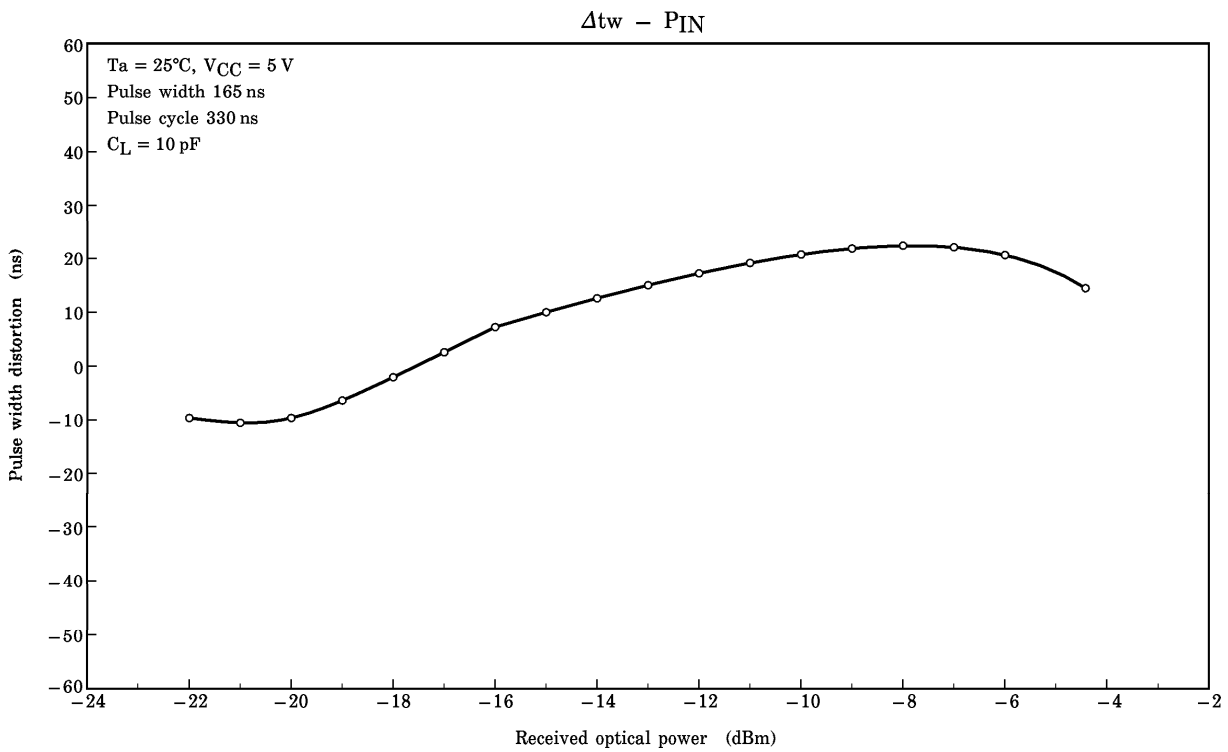

⁽¹⁰⁾ There give characteristic examples, and its values are not guaranteed.

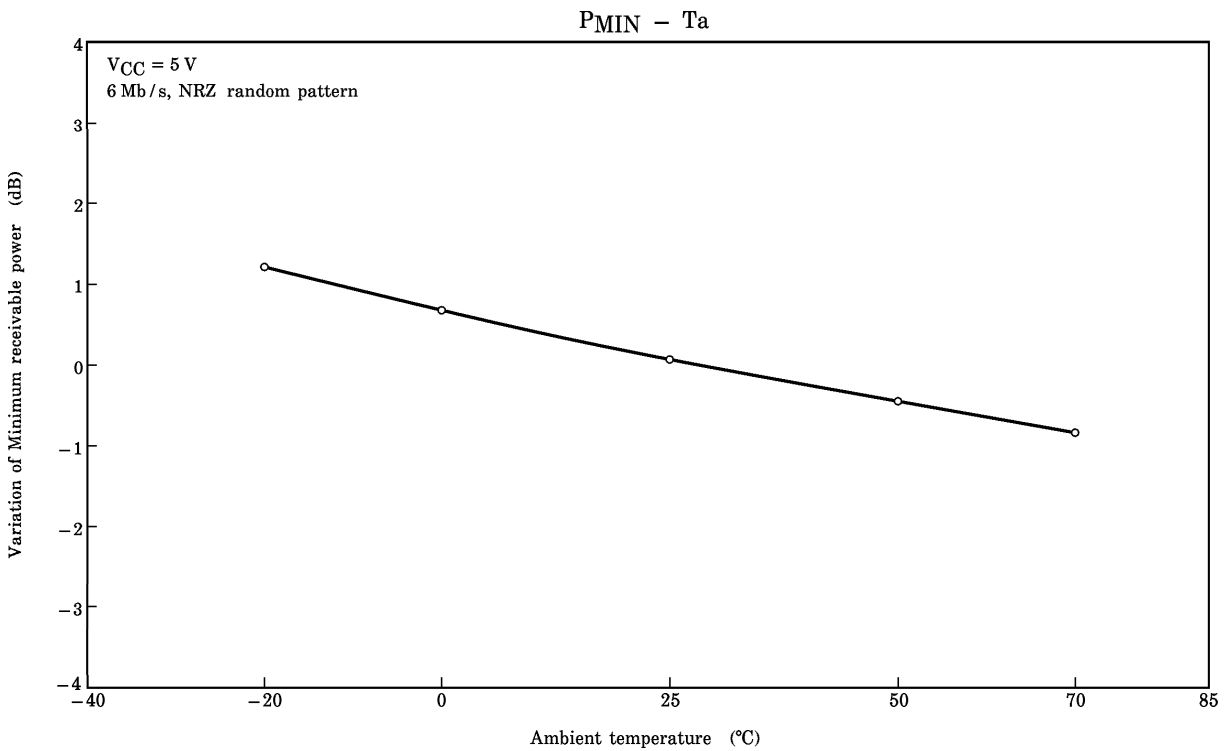
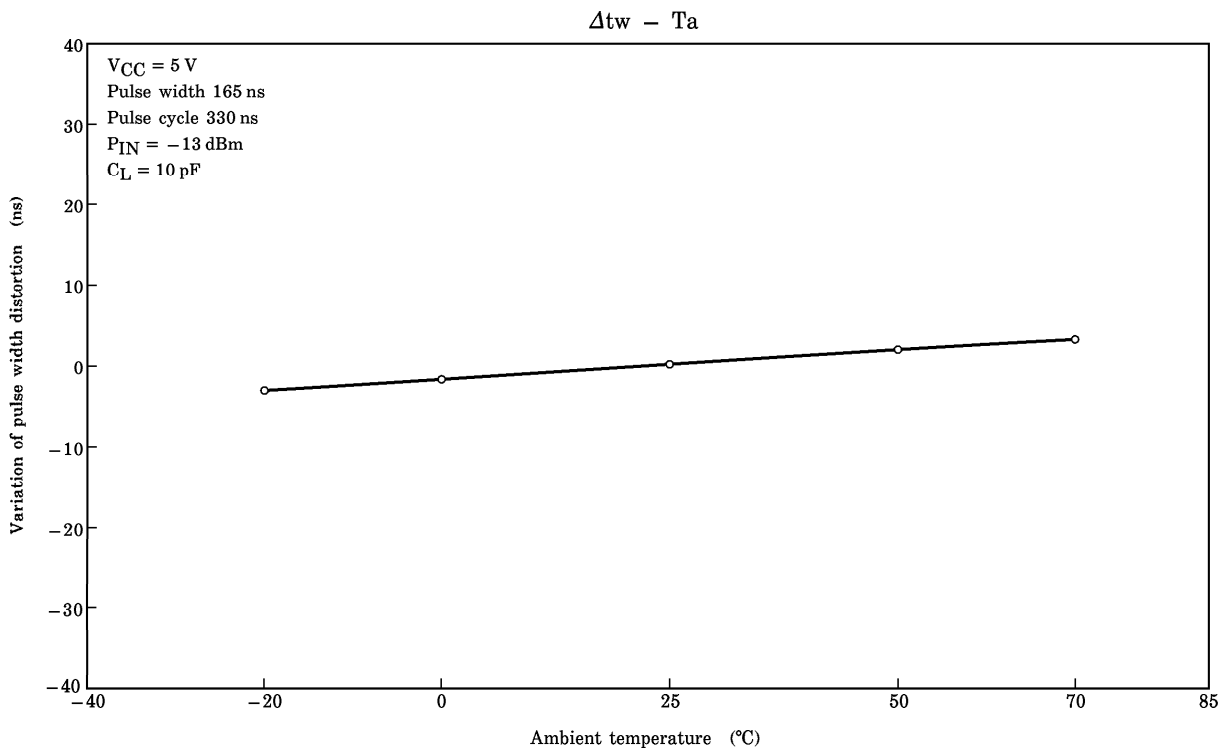

⁽¹⁰⁾ There give characteristic examples, and its values are not guaranteed.

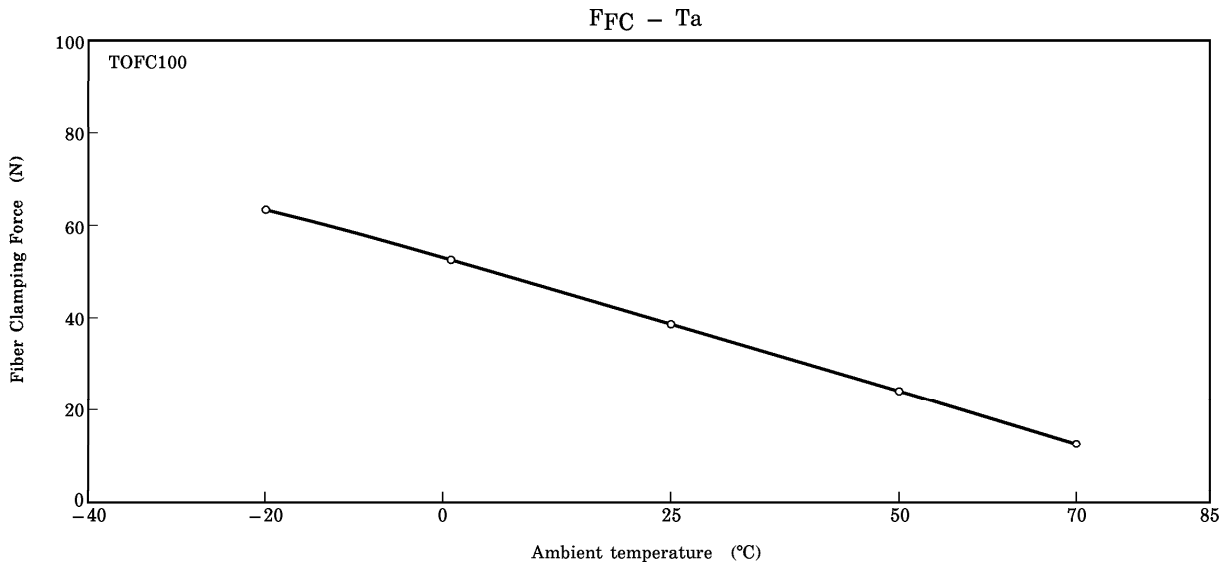

⁽¹⁰⁾ There give characteristic examples, and its values are not guaranteed.

6. Application Circuit

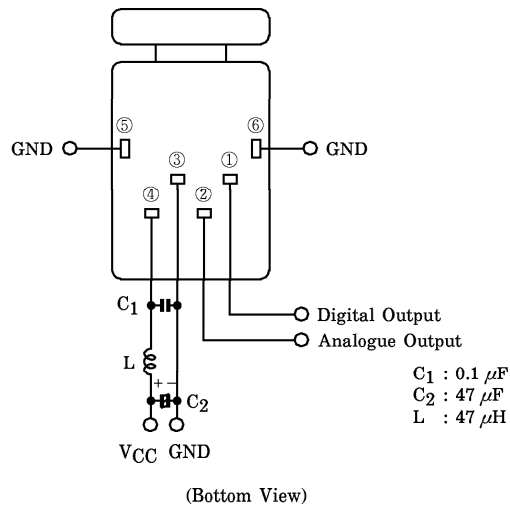

7. Precautions during use

(1) Maximum rating

The maximum ratings are the limit values which must not be exceeded during operation of device. None of these rating value must not be exceeded. If the maximum rating value is exceeded, the characteristics of devices may never be restored properly. In extreme cases, the device may be permanently damages.

(2) Soldering

Optical modules are comprised of internal semiconductor devices. However, in principle, optical modules are optical components. During soldering, ensure that flux does not contact with the emitting surface or the detecting surface. Also ensure that proper flux removal is conducted after soldering.

Some optical modules come with a protective cap. The protective cap is used to avoid malfunction when the optical module is not in use. Note that it is not dust or waterproof. As mentioned before, optical modules are optical components. Thus, in principle, soldering where there may be flux residue and flux removal after soldering is not recommended. Toshiba recommend that soldering be performed without the optical module mounted on the board. Then, after the board has been cleaned, the optical module should be soldered on to the board manually.

If the optical module cannot be soldered manually, use non-halogen (chlorine-free) flux and make sure, without cleaning, there is no residue such as chlorine. This is one of the ways to eliminate the effects of flux. In such a cases, be sure to check the devices' reliability.

(3) Noise resistance

It is believed that the use of optical transfer devices improve noise resistance. In theory, optical fiber is not affected by noise at all. However, receiving modules which handle signals whose level is extremely small, are susceptible to noise.

TOSLINK improve noise resistance to use a conductive case. However, the current signal output by the optical receiving modules' photodiode is extremely small. Thus, in some environments, shielding the case may not achieve sufficient noise resistance.

First systems which incorporate TOSLINK, Toshiba recommend testing using the actual device to check its noise resistance.

Use a simple noise filter on TOSLINK fiber optic transceiving module's power line. If the ripple in the power supply used is significant, reinforce the filter.

The optical module is to be used in an area which is susceptible to radiated noise, increase the shielding by covering the optical module and the power line filter with a metallic cover.

(4) Vibration and shock

This module is plastic sealed and has its wire fixed by resin. This structure is relatively resistant to vibration and shock. In actual equipment, there are sometime cases in which vibration, shock, or stress is applied to soldered parts or connected parts, resulting in lines cut. A care must be taken in the design of equipment which will be subject to high levels of vibration.

(5) Fixing fiber optical receiving module

Solder the fixed pin (pins 5 and 6) of fiber optic receiving module TORX111 to the printed circuit board to fix the module to the board.

(6) Solvent

When using solvent for flux removal, do not use a high acid or high alkali solvent. Be careful not to pour solvent in to the optical connector ports. If solvent is inadvertently poured in to them, clean it off using cotton tips.

(7) Dirt

Note that dirt should not be in to a module.

(8) Optical fiber

Use TOFC100 or similar product for optical fiber. When cutting optical fiber, use an edged tool such as a cutter knife.

(9) Removing the optical fiber from the module

When removing the optical fiber from the module, push the ring. Note that not to pull the optical fiber out from the module without pushing the ring. The tip of the optical fiber may be cut off and remain in the module.

(10) Shielding and wiring pattern of fiber optic receiving modules

To shield, connect the fixed pins (pins 5 and 6) of fiber optic transceiving module TORX111 to the GND.

Where the fiber optic receiving module uses metal material, be careful that the case does not touch wiring (including land).

To improve noise resistance, shield the optical module and the power line filter using a metallic cover.

(11) Supply voltage

Use the supply voltage within the recommended operating condition ($V_{CC} = 5 \pm 0.25 \text{ V}$). Make sure that supply voltage does not exceed the maximum rating value of 7 V, even for an instant.

(12) Output

If the receiver output is at low and is connected to the power supply, or if the output is high and is connected to GND, the internal IC may be destroyed.

(13) Analogue Output

Pin No.2, fiber optic receiving module TORX111, is analog output terminal for observing the received optical power as a result of measuring analog output voltage.

When LED or other devices connect to analog output, use the buffer circuit.

When analog output terminal is not used, do not connect any circuit to it.

(14) Soldering condition

Solder at 260°C or less for no more than three seconds.

(15) Precautions when disposing of devices and packing materials.

When disposing devices and packing materials, follow the procedures stipulated by local regulations in order to protect the environment against contamination.

When devices are disposed of, worker safety and protection of the environment must be taken into account.

(16) Precautions during use

Toshiba is continually working to improve the quality and the reliability of their products. Nevertheless, semiconductor devices in general can malfunction or fail due to their inherent electrical sensitivity and their vulnerability to physical stress. It is the responsibility of the buyer, when utilizing Toshiba products, to observe standards of safety, and to avoid situations in which the malfunction or failure of a Toshiba product could cause loss of human life, bodily injury or damage to property.

When developing equipment, please ensure that Toshiba products are used within the specified operating ranges set forth in the most recent product specifications. Also, please keep in mind the precautions and conditions set forth in the Toshiba Semiconductor Reliability Handbook.