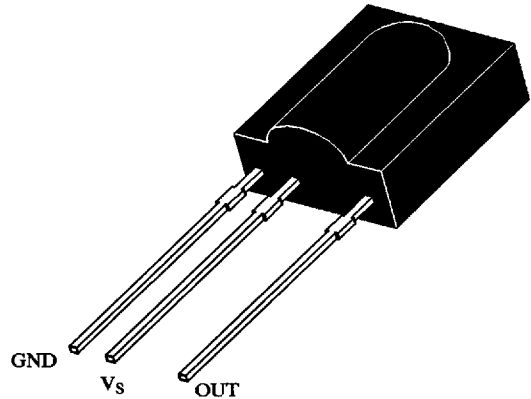

Photo Modules for PCM Remote Control Systems

Available types for different carrier frequencies

Type	f_0	Type	f_0
TFMS 5300	30 kHz	TFMS 5330	33 kHz
TFMS 5360	36 kHz	TFMS 5370	36.7 kHz
TFMS 5380	38 kHz	TFMS 5400	40 kHz
TFMS 5560	56 kHz		



94 8691

Description

The TFMS 5..0 – series are miniaturized receivers for infrared remote control systems. PIN diode and preamplifier are assembled on lead frame, the epoxy package is designed as IR filter.

The demodulated output signal can directly be decoded by a microprocessor. The main benefit is the reliable function even in disturbed ambient and the protection against uncontrolled output pulses.

Features

- Photo detector and preamplifier in one package
- Output active low. (active high modules: TFMS 5..9)
- Internal filter for PCM frequency
- High immunity against ambient light
- Improved shielding against electric field disturbance
- 5 Volt supply voltage, low power consumption
- TTL and CMOS compatibility
- Continuous transmission possible ($t_{pi}/T \leq 0.4$)

Block Diagram

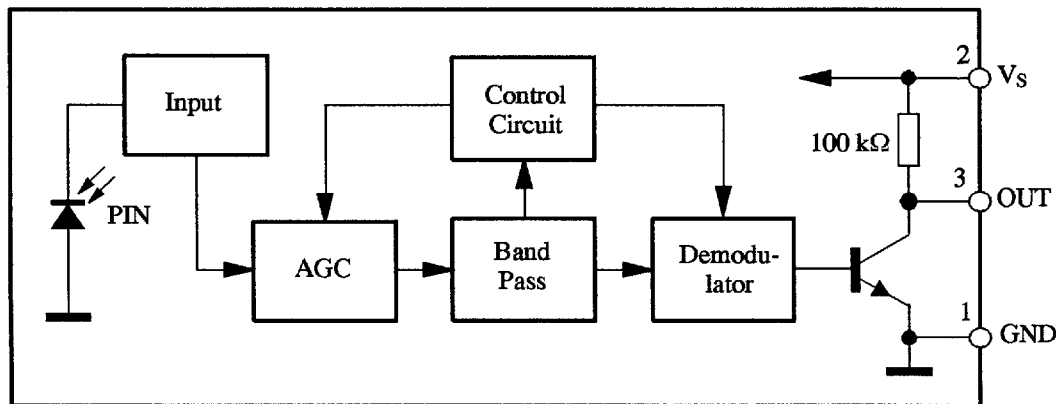

94 8136

Absolute Maximum Ratings

$T_{amb} = 25^{\circ}\text{C}$

Parameter	Test Conditions	Symbol	Value	Unit
Supply Voltage	(Pin 2)	V_S	-0.3...6.0	V
Supply Current	(Pin 2)	I_S	5	mA
Output Voltage	(Pin 3)	V_O	-0.3...6.0	V
Output Current	(Pin 3)	I_O	5	mA
Junction Temperature		T_j	100	$^{\circ}\text{C}$
Storage Temperature Range		T_{stg}	-25...+85	$^{\circ}\text{C}$
Operating Temperature Range		T_{amb}	-25...+85	$^{\circ}\text{C}$
Power Consumption	($T_{amb} \leq 85^{\circ}\text{C}$)	P_{tot}	50	mW
Soldering Temperature	$t \leq 10\text{ s}$, 1 mm from case	T_{sd}	260	$^{\circ}\text{C}$

Basic Characteristics

$T_{amb} = 25^{\circ}\text{C}$

Parameter	Test Conditions	Symbol	Min	Typ	Max	Unit
Supply Current (Pin 2)	$V_S = 5\text{ V}$, $E_v = 0$	I_{SD}	0.4	0.5	0.8	mA
Supply Current (Pin 2)	$V_S = 5\text{ V}$, $E_v = 40\text{ klx}$, sunlight	I_{SH}		1.0		mA
Transmission Distance	$E_v = 0$, Test signal see Fig.7, IR diode TSIP5201, $I_F = 1.5\text{ A}$	d		35		m
Output Voltage Low (Pin 3)	$I_{OSL} = 0.5\text{ mA}$, $E_e = 0.7\text{ mW/m}^2$, $f = f_o$, $t_p/T = 0.4$	V_{OSL}			250	mV
Irradiance (30 - 40 kHz)	Pulse width tolerance: $t_{po} = t_{pi} \pm 160\mu\text{s}$, Test signal (see Fig.7)	$E_{e\ min}$		0.3	0.5	mW/m^2
Irradiance (56 kHz)	Pulse width tolerance: $t_{po} = t_{pi} \pm 160\mu\text{s}$, Test signal (see Fig.7)	$E_{e\ min}$		0.4	0.7	mW/m^2
Irradiance		$E_{e\ max}$	20			W/m^2
Directivity	Angle of half transmission distance	$\varphi_{1/2}$		± 55		deg

Application Circuit

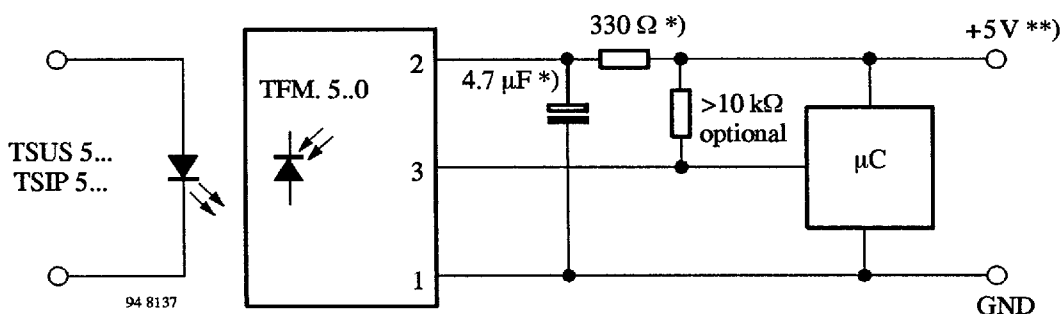

*) only necessary to suppress power supply disturbances

***) tolerated supply voltage range : $4.5\text{ V} < V_S < 5.5\text{ V}$

Typical Characteristics ($T_{amb} = 25^{\circ}\text{C}$ unless otherwise specified)

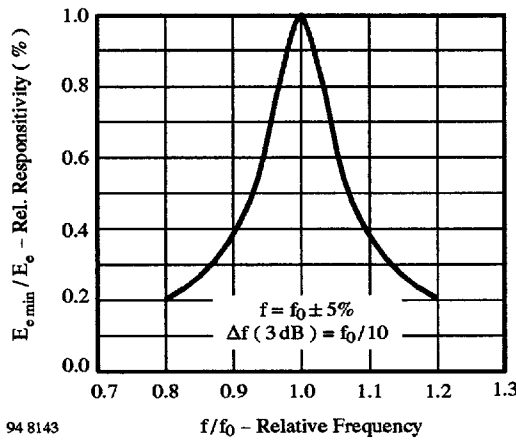

Figure 1 : Frequency Dependence of Responsivity

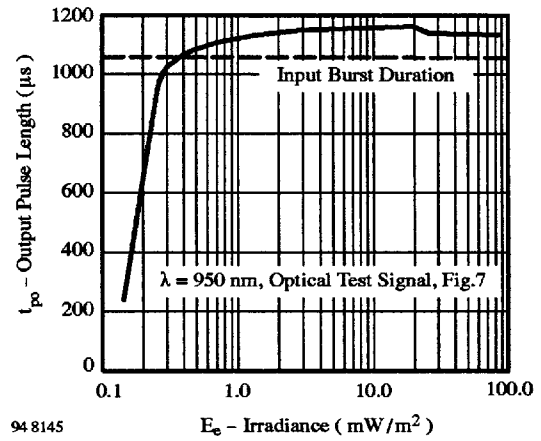

Figure 2 : Sensitivity in Dark Ambient

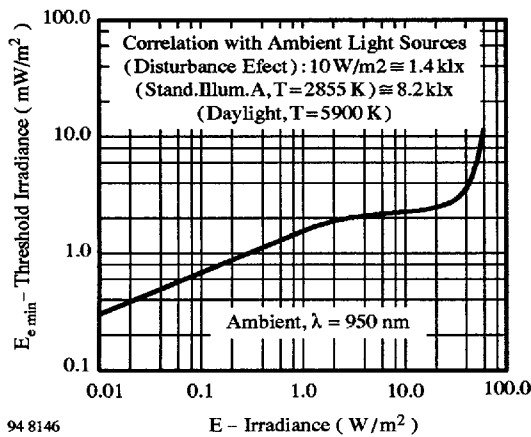

Figure 3 : Sensitivity in Bright Ambient

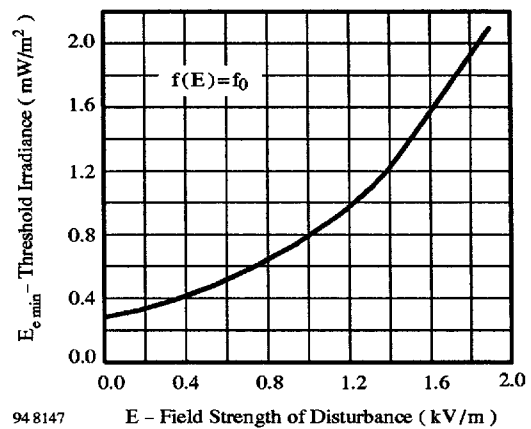

Figure 4 : Sensitivity vs. Electric Field Disturbances

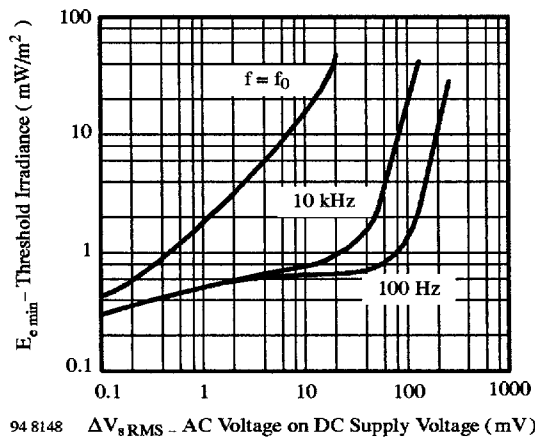

Figure 5 : Sensitivity vs. Supply Voltage Disturbances

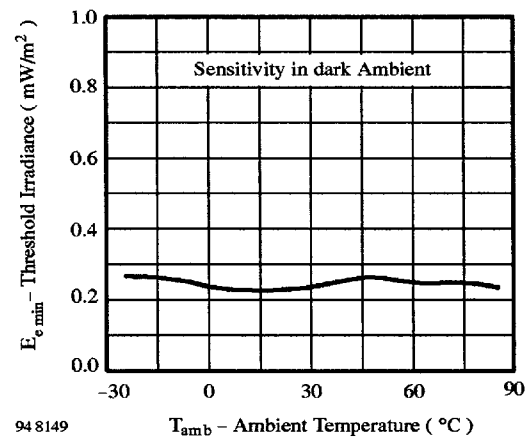

Figure 6 : Sensitivity vs. Temperature

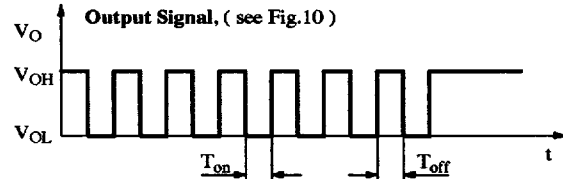
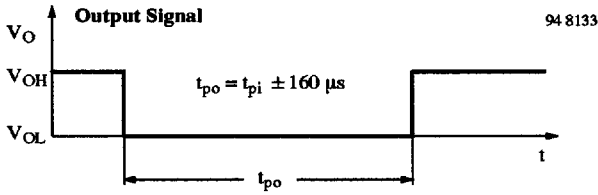
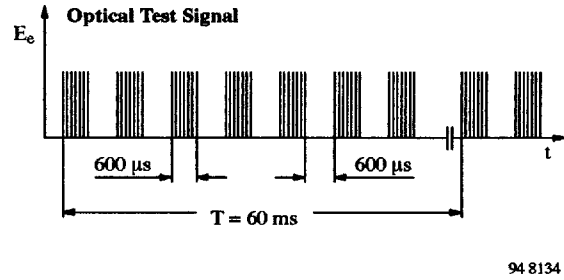
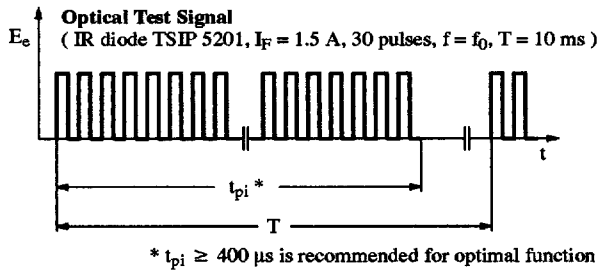

Figure 7 : Output Function

Figure 8 : Output Function

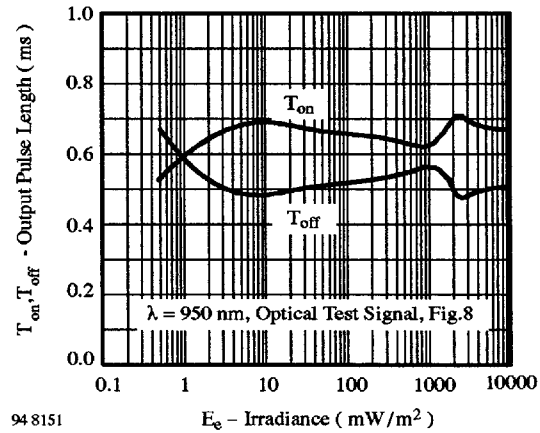
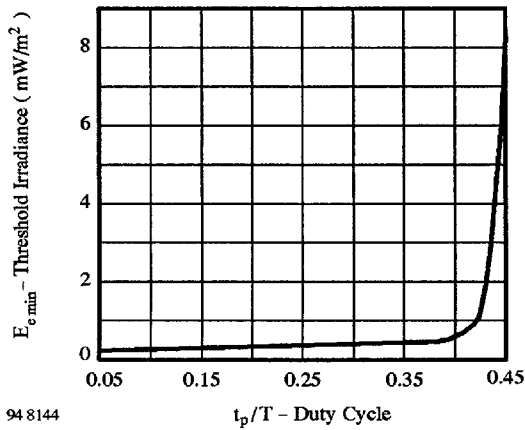

Figure 9 : Sensitivity vs. Duty Cycle

Figure 10 : Output Pulse Diagram

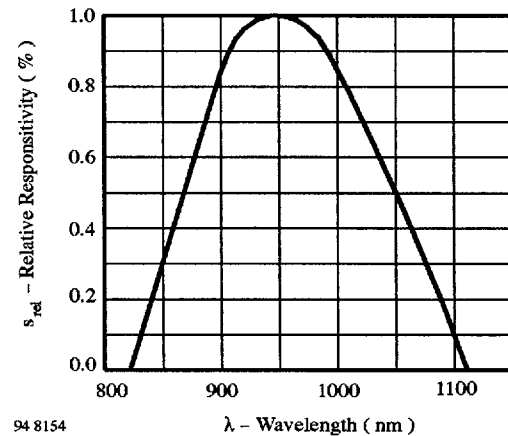
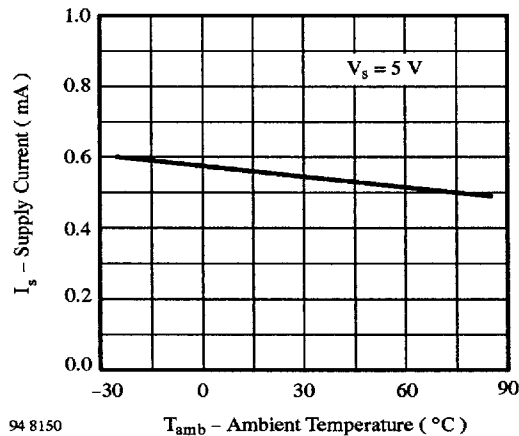

Figure 11 : Supply Current vs. Temperature

Figure 12 : Spectral Response

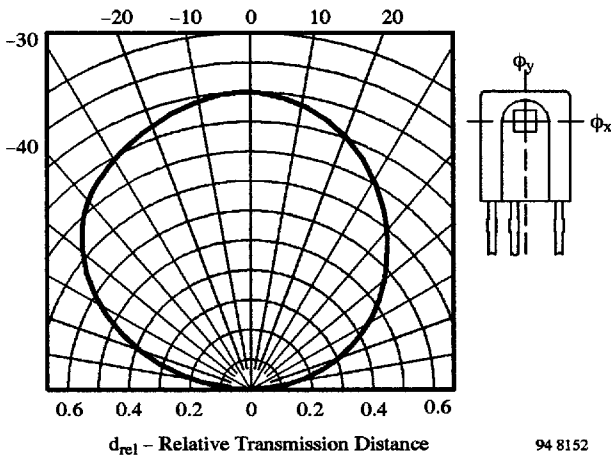

Figure 13 : Vertical Directivity ϕ_y

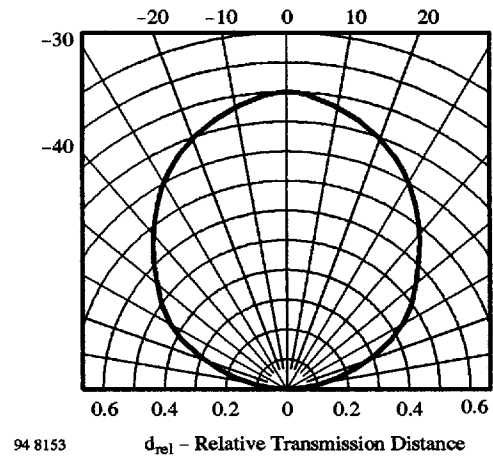
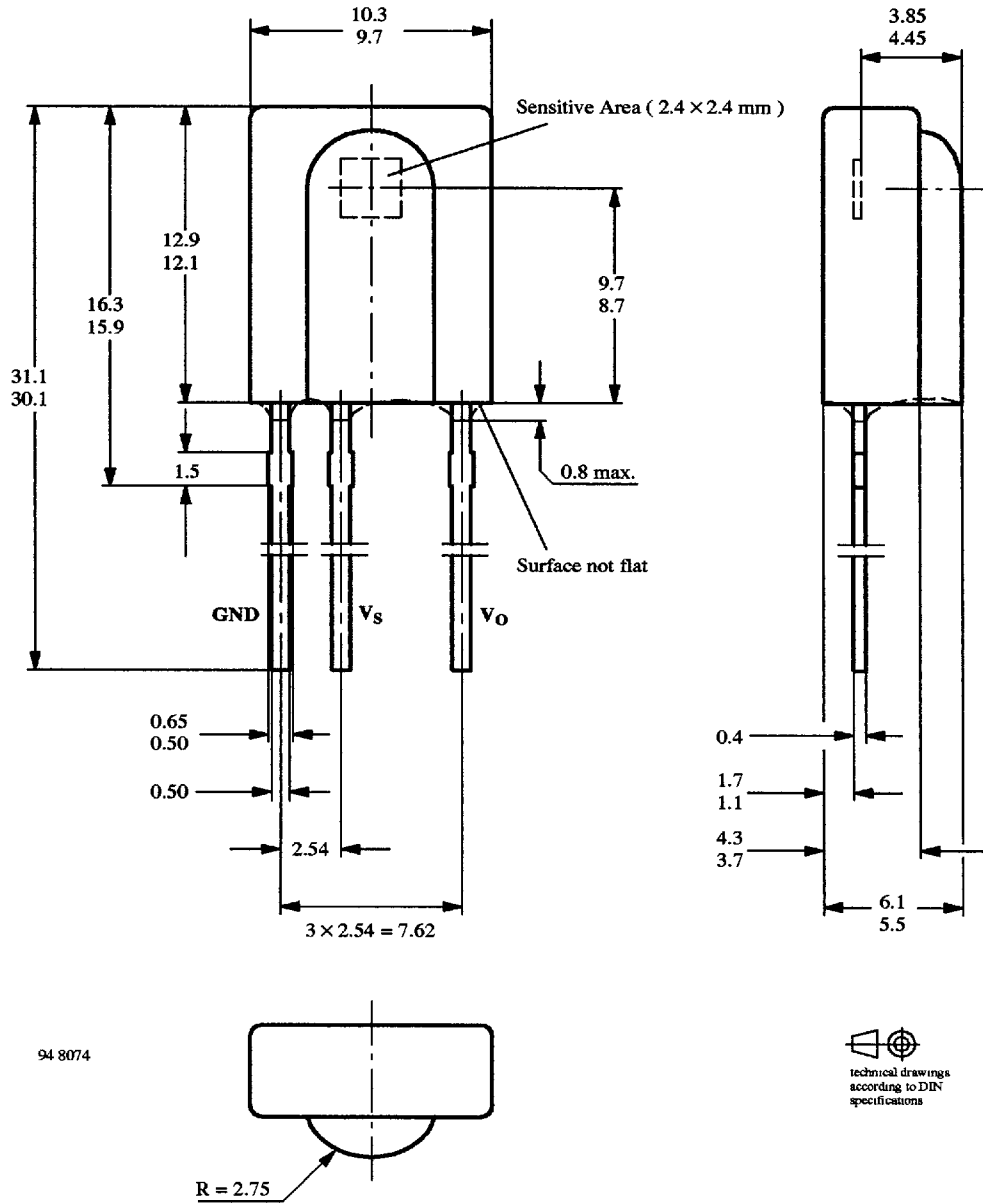

Figure 14 : Horizontal Directivity ϕ_x

Dimensions in mm



We reserve the right to make changes to improve technical design without further notice. Parameters can vary in different applications. All operating parameters must be validated for each customer application by the customer. Should the buyer use TEMIC products for any unintended or unauthorized application, the buyer shall indemnify TEMIC against all claims, costs, damages, and expenses, arising out of, directly or indirectly, any claim of personal damage, injury or death associated with such unintended or unauthorized use.

TEMIC TELEFUNKEN microelectronic GmbH, P.O.B. 3535, D-74025 Heilbronn, Germany
 Telephone: 49 (0)7131 67 2831, Fax Number: 49 (0)7131 67 2423