

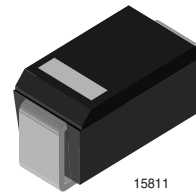

Surface Mount Zener Diodes

Features

- Plastic package has Underwriters Laboratory Flammability Classification 94 V-0
- For surface mounted applications
- Low Zener impedance
- Low regulation factor
- High temperature soldering guaranteed: 260 °C/10 seconds at terminals
- Standard voltage tolerance is 10 %, Suffix A ± 5 %.



Mechanical Data

Case: JEDEC DO-214AC molded plastic over passivated junction

Terminals: Solder plated, solderable per MIL-STD-750, Method 2026

Polarity: Color band denotes positive end (cathode)

Mounting Position: Any

Weight: 0.002 ounce, 64 mg

Packaging Codes - Options (Antistatic):

SML4728 - SML4737A:

11T - 1.8 k per 7" plastic reel (12mm tape), 36 k/carton

5AT - 7.5 k per 13" plastic reel (12mm tape), 75 k/carton

SML4738 - SML4764A:

61 - 1.8 k per 7" plastic reel (12mm tape), 36 k/carton

5A - 7.5 k per 13" plastic reel (12mm tape), 75 k/carton

Absolute Maximum Ratings

$T_{amb} = 25$ °C, unless otherwise specified

Parameter	Test condition	Symbol	Value	Unit
Power dissipation	$T_L = 75$ °C	P_{tot}	1.0	W

Thermal Characteristics

$T_{amb} = 25$ °C, unless otherwise specified

Parameter	Test condition	Symbol	Value	Unit
Maximum junction temperature		T_j	150	°C
Storage temperature range		T_S	- 65 to + 150	°C

SML4728 to SML4764A



Vishay Semiconductors

Electrical Characteristics

Partnumber	Device Marking Code	Nominal Zener Voltage	Test Current	Maximum Dynamic ImpedanceResistance			Maximum DC Reverse Leakage Current		Maximum Surge Current
				$Z_{ZT} @ I_{ZT}$	$Z_{ZK} @ I_{ZK}$	I_{ZK}	I_R	V_R	
		$V_Z^{1)}$ @ I_{ZT}	I_{ZT}	Ω	Ω	mA	μA	V	$I_{RM}^{2)}$
		V	mA	Ω	Ω	mA	μA	V	mApk
SML4728	3P3	3.3	76	10	400	1	100	1	1380
SML4729	3P6	3.6	69	10	400	1	100	1	1260
SML4730	3P9	3.9	64	9	400	1	50	1	1190
SML4731	4P3	4.3	58	9	400	1	10	1	1070
SML4732	4P7	4.7	53	8	500	1	10	1	970
SML4733	5P1	5.1	49	7	550	1	10	1	890
SML4734	5P6	5.6	45	5	600	1	10	2	810
SML4735	6P2	6.2	41	2	700	1	10	3	730
SML4736	6P8	6.8	37	3.5	700	1	10	4	660
SML4737	7P5	7.5	34	4	700	0.5	10	5	605
SML4738	8P2	8.2	31	4.5	700	0.5	10	6	550
SML4739	9P1	9.1	28	5	700	0.5	10	7	500
SML4740	10	10	25	7	700	0.25	10	7.6	454
SML4741	11	11	23	8	700	0.25	5	8.4	414
SML4742	12	12	21	9	700	0.25	5	9.1	380
SML4743	13	13	19	10	700	0.25	5	9.9	344
SML4744	15	15	17	14	700	0.25	5	11.4	305
SML4745	16	16	15.5	16	700	0.25	5	12.2	285
SML4746	18	18	14	20	750	0.25	5	13.7	250
SML4747	20	20	12.5	22	750	0.25	5	15.2	225
SML4748	22	22	11.5	23	750	0.25	5	16.7	205
SML4749	24	24	10.5	25	750	0.25	5	18.2	190
SML4750	27	27	9.5	35	750	0.25	5	20.6	170
SML4751	30	30	8.5	40	1000	0.25	5	22.8	150
SML4752	33	33	7.5	45	1000	0.25	5	25.1	135
SML4753	36	36	7	50	1000	0.25	5	27.4	125
SML4754	39	39	6.5	60	1000	0.25	5	29.7	115
SML4755	43	43	6	70	1500	0.25	5	32.7	110
SML4756	47	47	5.5	80	1500	0.25	5	35.8	95
SML4757	51	51	5	95	1500	0.25	5	38.8	90
SML4758	56	56	4.5	110	2000	0.25	5	42.6	80
SML4759	62	62	4	125	2000	0.25	5	47.1	70
SML4760	68	68	3.7	150	2000	0.25	5	51.7	65
SML4761	75	75	3.3	175	2000	0.25	5	56	60
SML4762	82	82	3	200	3000	0.25	5	62.2	55
SML4763	91	91	2.8	250	3000	0.25	5	69.2	50
SML4764	100	100	2.5	350	3000	0.25	5	76	45

¹⁾ Based on dc- measurement at thermal equilibrium

²⁾ Surge current is a non-repetitive, 8.3 ms pulse width square wave or equivalent sine-wave superimposed on I_{ZT} per JEDEC Method

Typical Characteristics ($T_{amb} = 25\text{ }^{\circ}\text{C}$ unless otherwise specified)

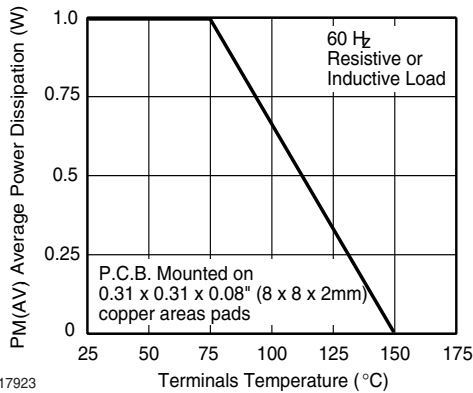

Fig. 1 Maximum Continuous Power Dissipation

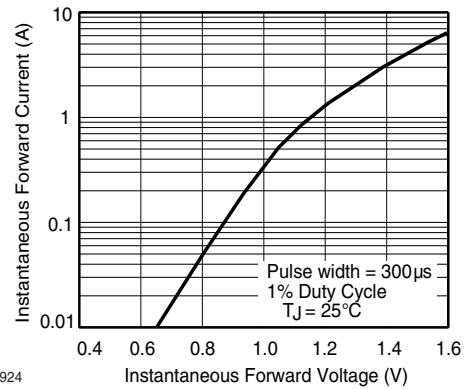

Fig. 4 Typical Instantaneous Forward Characteristics for SML4763

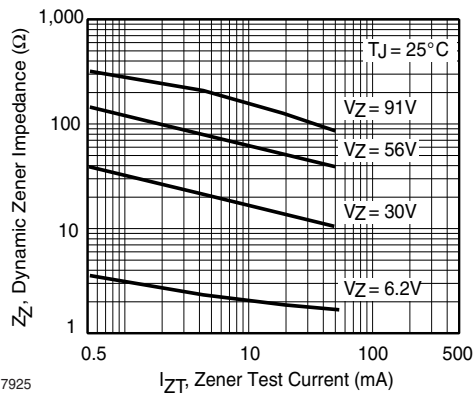

Fig. 2 Typical Zener Impedance

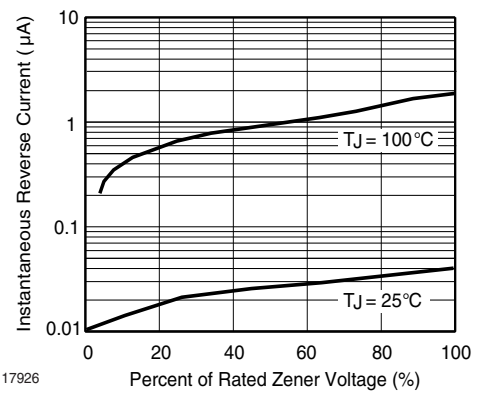

Fig. 5 Typical Reverse Characteristics

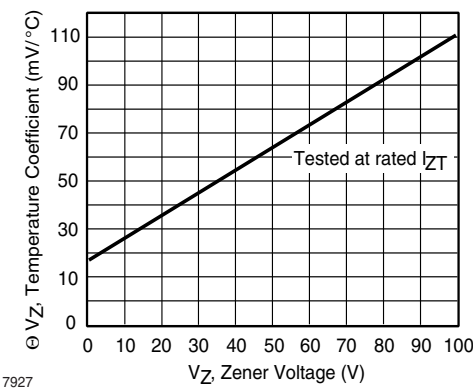

Fig. 3 Typical Temperature Coefficients

SML4728 to SML4764A



Vishay Semiconductors

Package Dimensions in mm (Inches)

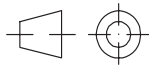

technical drawings
according to DIN
specifications

Plastic case
JEDEC DO-214
similar to SMA
Cathode indicated
by a band

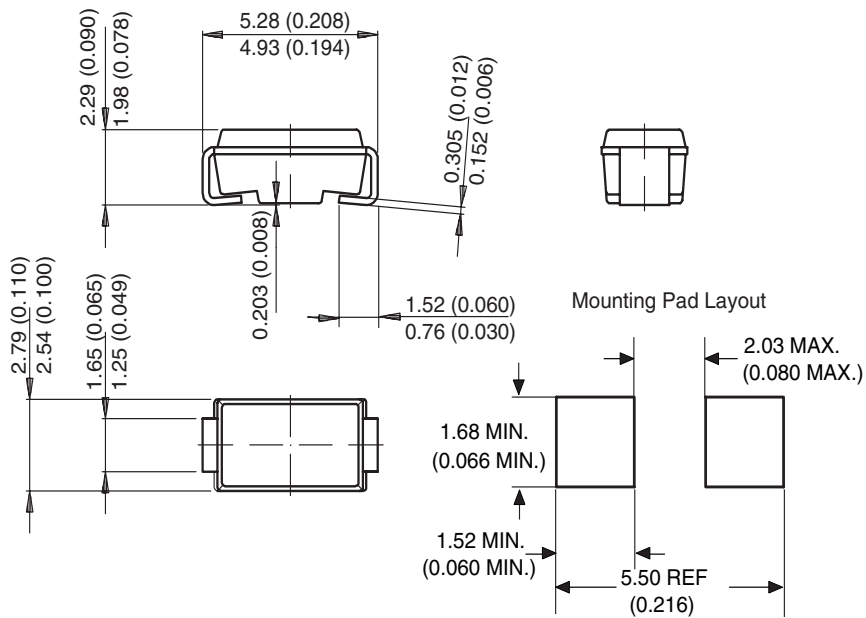

14275



Ozone Depleting Substances Policy Statement

It is the policy of **Vishay Semiconductor GmbH** to

1. Meet all present and future national and international statutory requirements.
2. Regularly and continuously improve the performance of our products, processes, distribution and operating systems with respect to their impact on the health and safety of our employees and the public, as well as their impact on the environment.

It is particular concern to control or eliminate releases of those substances into the atmosphere which are known as ozone depleting substances (ODSs).

The Montreal Protocol (1987) and its London Amendments (1990) intend to severely restrict the use of ODSs and forbid their use within the next ten years. Various national and international initiatives are pressing for an earlier ban on these substances.

Vishay Semiconductor GmbH has been able to use its policy of continuous improvements to eliminate the use of ODSs listed in the following documents.

1. Annex A, B and list of transitional substances of the Montreal Protocol and the London Amendments respectively
2. Class I and II ozone depleting substances in the Clean Air Act Amendments of 1990 by the Environmental Protection Agency (EPA) in the USA
3. Council Decision 88/540/EEC and 91/690/EEC Annex A, B and C (transitional substances) respectively.

Vishay Semiconductor GmbH can certify that our semiconductors are not manufactured with ozone depleting substances and do not contain such substances.

**We reserve the right to make changes to improve technical design
and may do so without further notice.**

Parameters can vary in different applications. All operating parameters must be validated for each customer application by the customer. Should the buyer use Vishay Semiconductors products for any unintended or unauthorized application, the buyer shall indemnify Vishay Semiconductors against all claims, costs, damages, and expenses, arising out of, directly or indirectly, any claim of personal damage, injury or death associated with such unintended or unauthorized use.

Vishay Semiconductor GmbH, P.O.B. 3535, D-74025 Heilbronn, Germany
Telephone: 49 (0)7131 67 2831, Fax number: 49 (0)7131 67 2423