

## GENERAL PURPOSE PHOTO REFLECTOR

### ■ GENERAL DESCRIPTION

The NJL5198K/5199K are super miniature and super thin general purpose photo reflectors designed for car-audio applications. Durability under temperature cycle has been greatly improved same as NJL5175K/5177K (compared to our conventional products, the durability has been doubled.), and attain high cost performance.

### ■ FEATURES

- Super miniature, super thin type
- Built-in visible light cut-off filter.
- High output, high S/N ratio, high durability.

### ■ APPLICATIONS

- The end detector for video or audio tape etc.
- Rotation detection and control to be applied for car-audio turntables.

### ■ ABSOLUTE MAXIMUM RATINGS (Ta=25 °C)

PARAMETER	SYMBOL	RATINGS	UNIT
<b>Emitter</b>			
Forward Current (Continuous)	$I_F$	30	mA
Reverse Voltage (Continuous)	$V_R$	6	V
Power Dissipation	$P_D$	45	mW
<b>Detector</b>			
Collector-Emitter Voltage	$V_{CEO}$	16	V
Emitter-Collector Voltage	$V_{ECO}$	6	V
Collector Current	$I_C$	10	mA
Collector Power Dissipation	$P_C$	25	mW
<b>Coupled</b>			
Total Power Dissipation	$P_{tot}$	60	mW
Operating Temperature	$T_{opr}$	-30~+85	°C
Storage Temperature	$T_{stg}$	-40~+85	°C
Soldering Temperature	$T_{sol}$	260 (10sec. 1.5mm from body)	

### ■ ELECTRO-OPTICAL CHARACTERISTICS (Ta=25 °C)

PARAMETER	SYMBOL	TEST CONDITION	MIN.	TYP.	MAX.	UNIT
<b>Emitter</b>						
Forward Voltage	$V_F$	$I_F=4mA$	—	—	1.4	V
Reverse Current	$I_R$	$V_R=6V$	—	—	10	$\mu A$
Capacitance	$C_t$	$V_R=0V, f=1MHz$	—	25	—	pF
<b>Detector</b>						
Dark Current	$I_{CEO}$	$V_{CE}=10V$	—	—	0.2	$\mu A$
Collector-Emitter Voltage	$V_{CEO}$	$I_C=100\mu A$	16	—	—	V
<b>Coupled</b>						
Output Current	$I_O$	$I_F=4mA, V_{CE}=2V, d=0.7mm$	35	—	—	$\mu A$
Operating Dark Current	$I_{CEO D}$	$I_F=4mA, V_{CE}=2V$	—	—	0.2	$\mu A$
Rise Time	$t_r$	$I_O=100\mu A, V_{CE}=2V, RL=1K\Omega, d=0.7mm$	—	30	—	$\mu S$
Fall Time	$t_f$	$I_O=100\mu A, V_{CE}=2V, RL=1K\Omega, d=0.7mm$	—	30	—	$\mu S$

# NJL5198K/99K

■ OUTLINE (typ.) Unit: mm

2

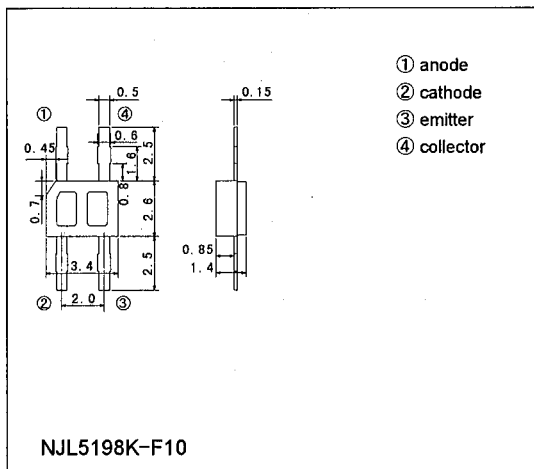
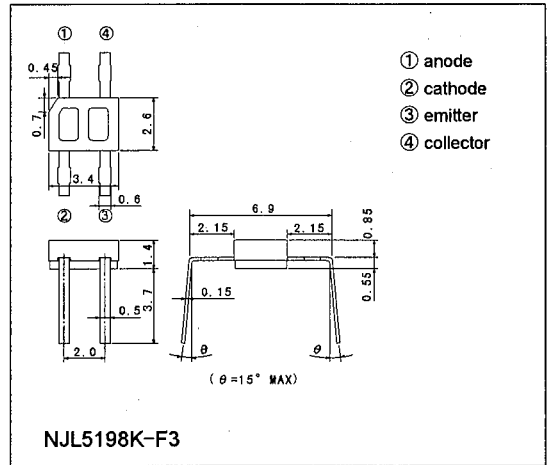
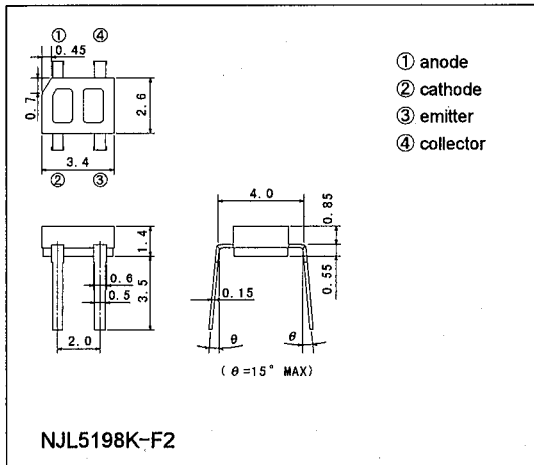
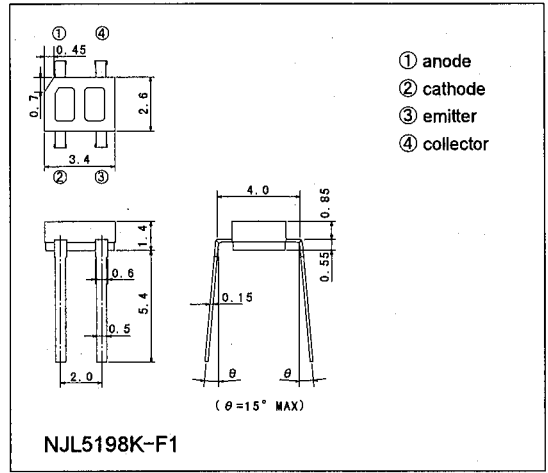
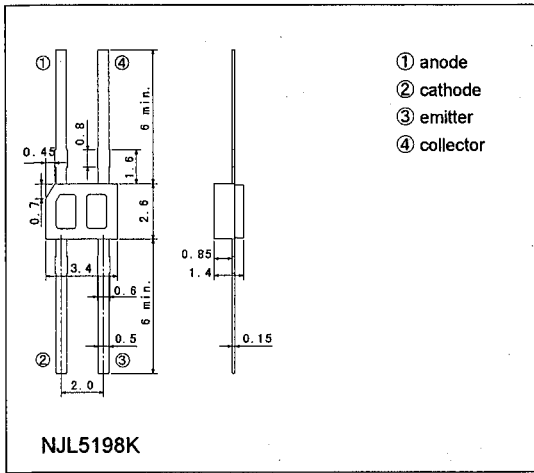

■ OUTLINE (typ.) Unit: mm

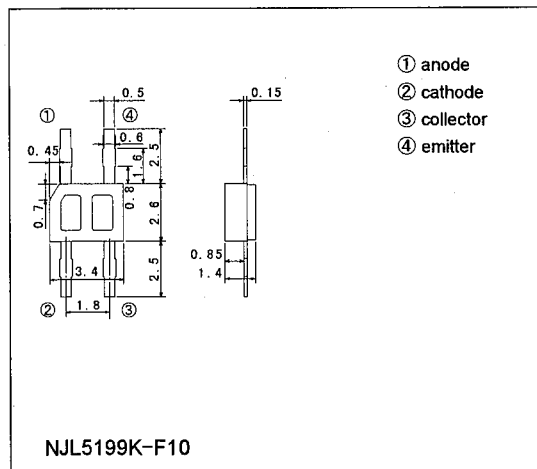
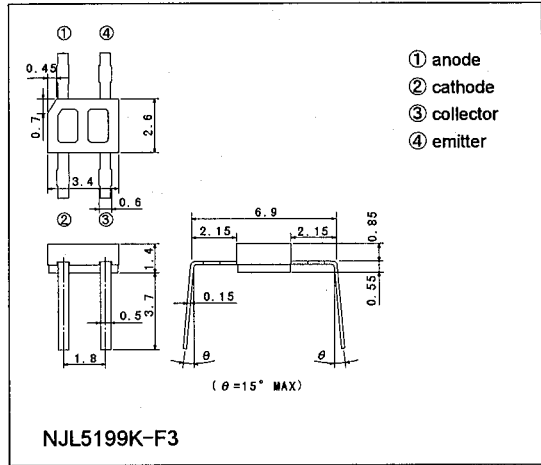
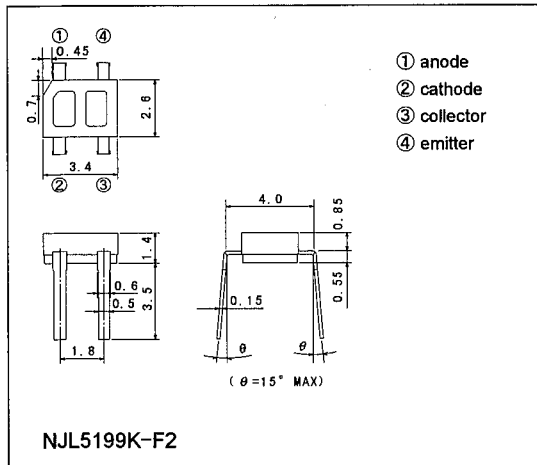
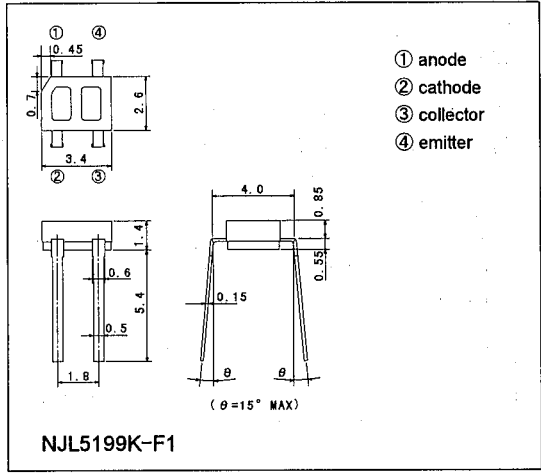
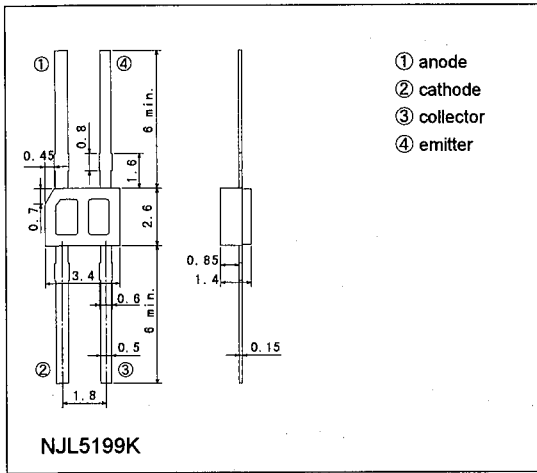

2

## MEASURING SPECIFICATION FOR OUTPUT CURRENT

The output current can be measured when reflected at the aluminum

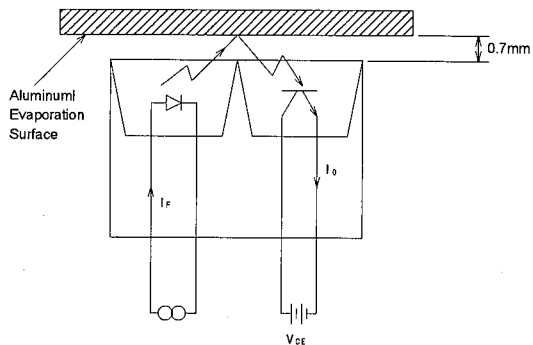

## MEASURING CIRCUIT FOR OPERATING DARK CURRENT

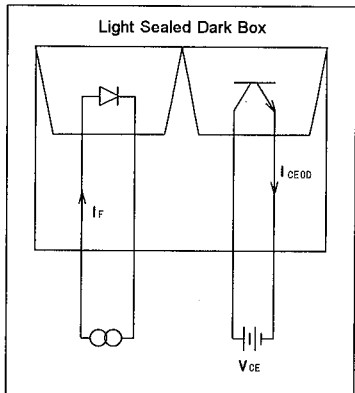

## MEASURING SPECIFICATION FOR EDGE RESPONSE

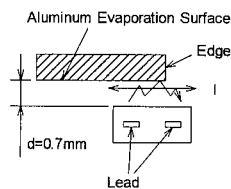

## MEASURING CIRCUIT FOR RESPONSE TIME

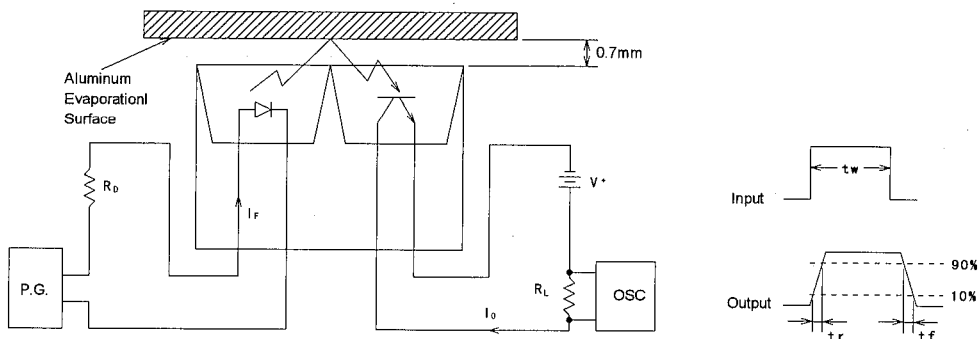

## MAXIMUM RATING CURVES

Power Dissipation vs. Temperature

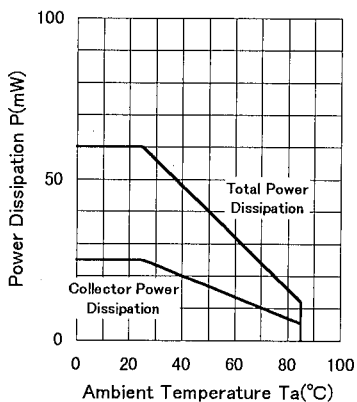

Forward Current vs. Temperature

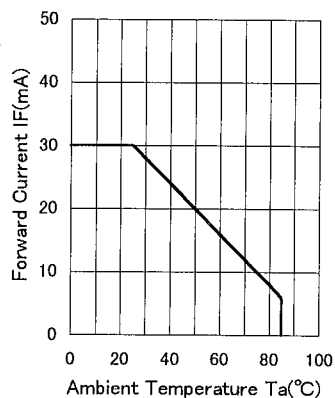

■ TYPICAL CHARACTERISTICS

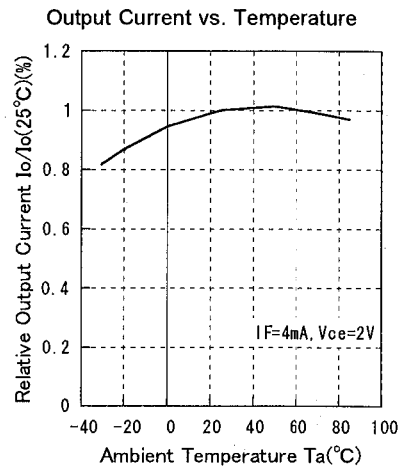
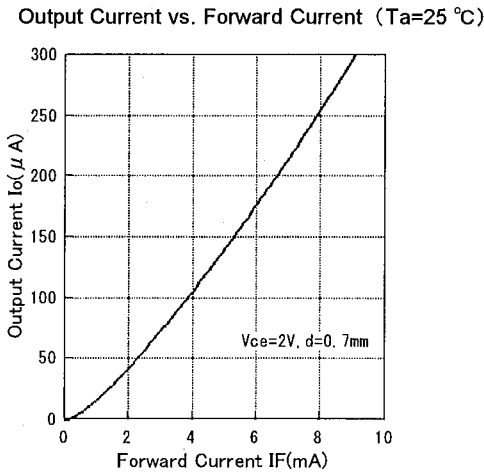
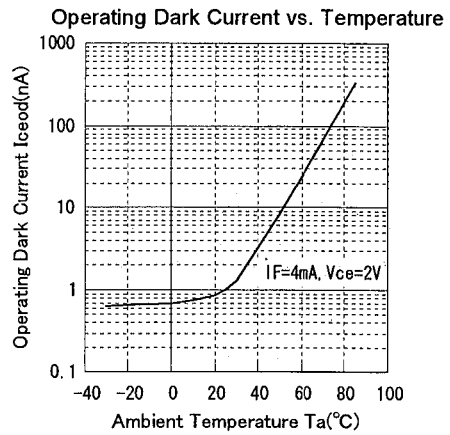
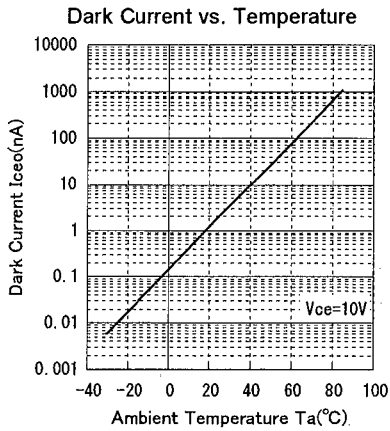
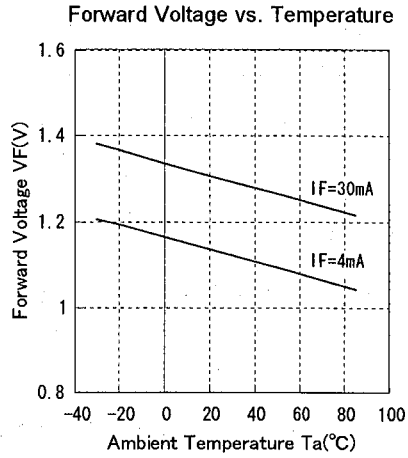
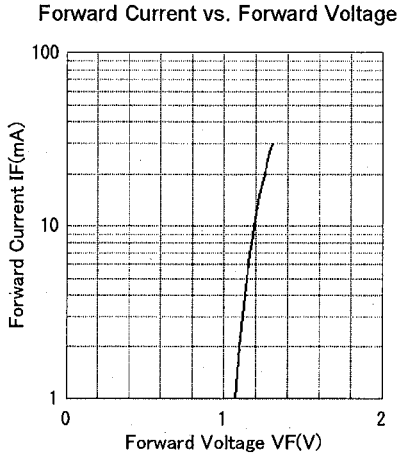

2

2

Output Characteristics (Ta=25 °C)

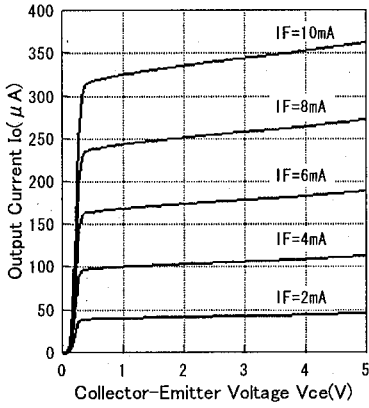

Vce Saturation (Ta=25 °C)

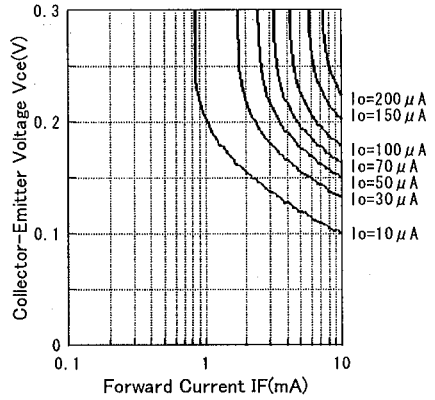

Output Current vs. Distance (Ta=25 °C)

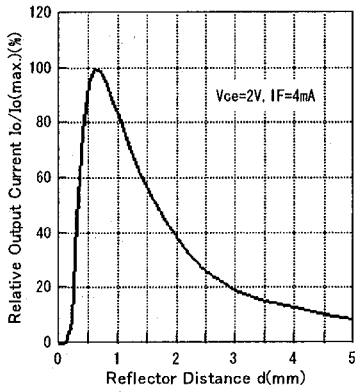

Output Current vs. Edge Distance (Ta=25 °C)

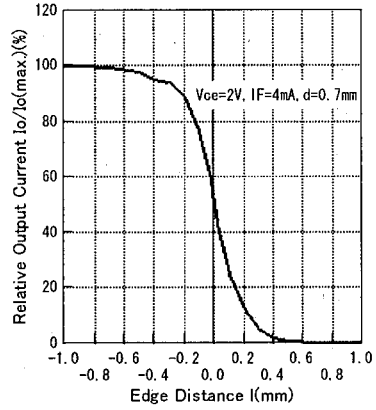

Spectral Response (Ta=25 °C)

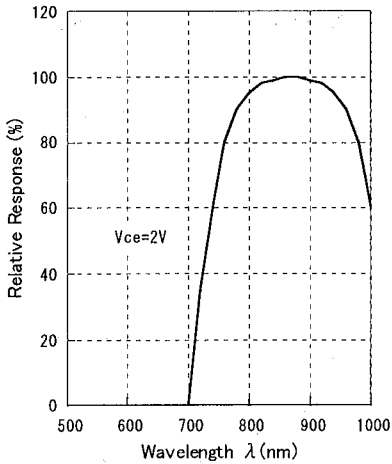

Switching Time vs. Load Resistance (Ta=25 °C)

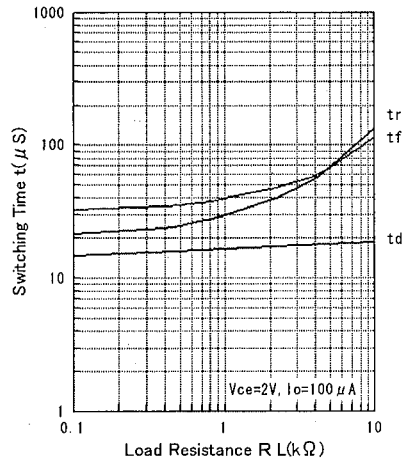

PRECAUTION FOR HANDLING

1. Soldering

1) Avoid the reflow method and solder to touch the body of the device during wave soldering. This is to prevent changes in optical characteristics of the device.

2) Recommended in Soldering

Temperature	Time Lead	Soldering Position
260 °C maximum	less than 10 seconds	At least 1.5mm from body

3) Soldering is recommended to be done in as short period of the time as possible by controlling the temperature of the soldering iron or by the iron of less than 15 watts.

4) The resin gets softened right after soldered, so, the following care has to be taken.

- Not to contact the lens surface to anything
- Not to dip the device into water or any solvents

5) It is recommended not to solder when the leads or between the lead get pulled, depressed or twisted.

6) In the case of using rosin flux, be careful to avoid contact with the lens surface. If the lens is covered with the flux, the specified characteristics cannot be achieved.



2. Post Solder Cleaning

1) Organic solvents for flux removal like trichloroethylene, acetone, thinner etc, might attach the lens surface. It is preferable to use less reactive solvents, Methyl Alcohol, Isopropyle Alcohol.

2) Cleaning Operation

Cleaning Solvent Temperature	: 35 °C maximum
Dipping Time	: 3 minute maximum

3. Attention in handling

1) Treat not to touch the lens surface.

2) Avoid dust and any other foreign materials(flux, paints, bonding material, etc) on the lens surface.

3) Never to apply reverse voltage ( $V_{EC}$ ) of more than 6V on the photo transistor when measuring the characteristics or adjusting the system. If applied, it causes to lower the sensitivity.

4) When mounting, special care has to be taken on the mounting position and tilting of the device because it is very important to place the device to the optimum position to the object.

4. Storage

The leads are silver plated and they are discolored if the device is left open to the air for long after taken out of the envelop. It causes deterioration of soldering characteristics. Mount the device as short as possible after opening the envelope.

## MEMO

[CAUTION]

The specifications on this databook are only given for information, without any guarantee as regards either mistakes or omissions. The application circuits in this databook are described only to show representative usages of the product and not intended for the guarantee or permission of any right including the industrial rights.