

THREE-TERMINAL LOW CURRENT POSITIVE VOLTAGE REGULATORS

The LM78L00 Series of positive voltage regulators are inexpensive, easy-to-use devices suitable for a multitude of applications that require a regulated supply of up to 100 mA. Like their higher powered LM7800 Series

cousins, these regulators feature internal current limiting and thermal shutdown making them remarkably rugged. No external components are required with the LM78L00 devices in many applications.

These devices offer a substantial performance advantage over the traditional zener diode-resistor combination, as output impedance and quiescent current are substantially reduced.

FEATURES

- Wide Range of Available, Fixed Output Voltages
- Low Cost
- Internal Short Circuit Current Limiting
- Internal Thermal Overload Protection
- No External Components Required
- Complementary Negative Regulators Offered (LM79L00 Series)
- Available in $\pm 2\%$ Voltage Tolerance.

CIRCUIT SCHEMATIC

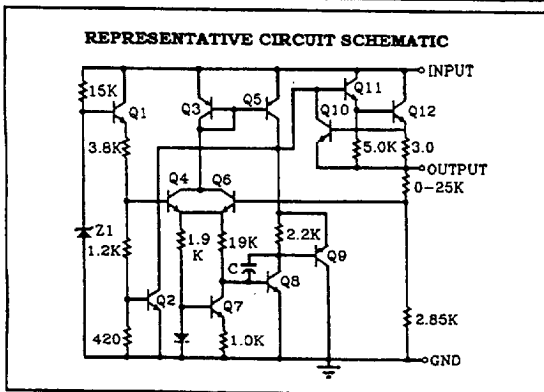

PIN ARRANGEMENT

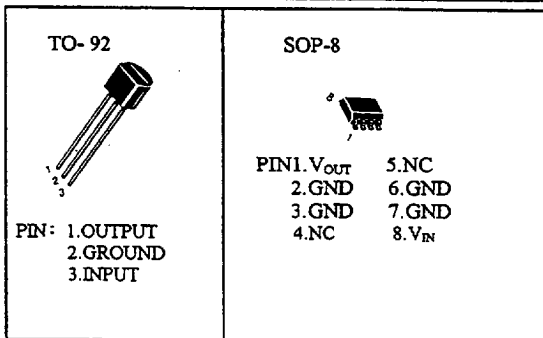

TYPICAL CONNECTING CIRCUIT

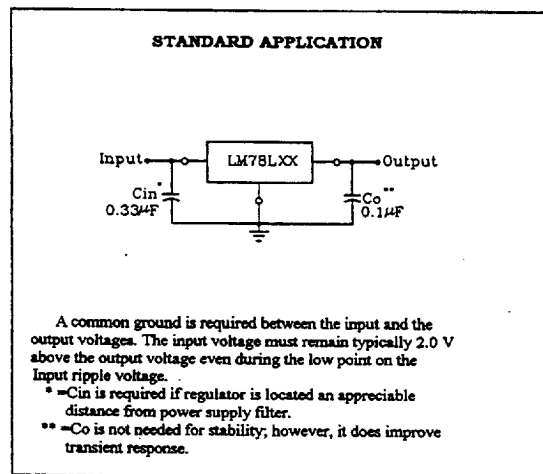

ORDERING INFORMATION

DEVICE	JUNCTION TEMPERATURE	PACKAGE
LM78L05	T _j =0°C TO +125°C	TO-92
LM78L05S		SOP-8

3719482 0001180 068

MAXIMUM RATINGS (Ta=+ 25°C unless otherwise noted.)

RATING	SYMBOL	VALUE	UNIT
Input Voltage	Vi	30	V
Storage Junction Temperature Range	Tstg	-65 TO +150	°C
Operating Junction Temperature Range	Tj	0 TO +125	°C

LM78L05/S ELECTRICAL CHARACTERISTICS :

(Vi=10V, Io=40mA, Ci=0.33µ F, Co=0.1µ F, 0°C <Tj<+125°C unless otherwise noted.)

CHARACTERISTIC	SYMBOL	MIN	TYP	MAX	UNIT
Output Voltage (Tj=+25°C)	Vo	4.9	5.0	5.1	Vdc
Line Regulation (Tj=+25°C, Io=40mA) 7.0V≤Vi≤20V 8.0V≤Vi≤20V	REGline		55 44	200 150	mV
Load Regulation Tj=+25°C, 1.0mA≤Io≤100mA Tj=+25°C, 1.0mA≤Io≤40mA	REGload		11 5.0	60 30	mV
Output Voltage 7.0V≤Vi≤20V, 1.0mA≤Io≤40mA Vi=10V, 1.0mA≤Io≤70mA	Vo	4.9 4.9		5.1 5.1	Vdc
Input Bias Current (Tj=+25°C) (Tj=+125°C)	IIB		3.8	6.0 5.5	mA
Input Bias Current Change 8.0V≤Vi≤20V 1.0mA≤Io≤40mA	Δ IIB			1.5 0.2	mA
Output Noise Voltage (Ta=+25°C, 10Hz≤f≤100KHz)	Vn		40		µ V
Ripple Rejection (Io=40mA, f=120Hz, 8.0V≤Vi≤18V, Tj=+25°C)	RR	40	49		dB
Dropout Voltage (Tj=+25°C)	Vi-Vo		1.7		Vdc

LM78L08/S ELECTRICAL CHARACTERISTICS :

($V_i=14V$, $I_o=40mA$, $C_i=0.33\mu F$, $C_o=0.1\mu F$, $0^\circ C < T_j < +125^\circ C$ unless otherwise noted.)

CHARACTERISTIC	SYMBOL	MIN	TYP	MAX	UNIT
Output Voltage ($T_j=+25^\circ C$)	V_o	7.84	8.0	8.16	Vdc
Line Regulation ($T_j=+25^\circ C$, $I_o=40mA$) $10.5V \leq V_i \leq 23V$ $11V \leq V_j \leq 23V$	REGline		20 12	200 150	mV
Load Regulation $T_j=+25^\circ C$, $1.0mA \leq I_o \leq 100mA$ $T_j=+25^\circ C$, $1.0mA \leq I_o \leq 40mA$	REGload		15 6.0	80 40	mV
Output Voltage $10.5V \leq V_i \leq 23V$, $1.0mA \leq I_o \leq 40mA$ $V_i=14V$, $1.0mA \leq I_o \leq 70mA$	V_o	7.74 7.74		8.26 8.26	Vdc
Input Bias Current ($T_j=+25^\circ C$) ($T_j=+125^\circ C$)	I_{IB}		3.0	6.0 5.5	mA
Input Bias Current Change $11V \leq V_i \leq 23V$ $1.0mA \leq I_o \leq 40mA$	ΔI_{IB}			1.5 0.2	mA
Output Noise Voltage ($T_a=+25^\circ C$, $10Hz \leq f \leq 100KHz$)	V_n		52		μV
Ripple Rejection ($I_o=40mA$, $f=120Hz$, $12V \leq V_i \leq 23V$, $T_j=+25^\circ C$)	RR	36	55		dB
Dropout Voltage ($T_j=+25^\circ C$)	V_i-V_o		1.7		Vdc

LM78L12/S ELECTRICAL CHARACTERISTICS :

($V_i=19V$, $I_o=40mA$, $C_i=0.33\mu F$, $C_o=0.1\mu F$, $0^\circ C < T_j < +125^\circ C$ unless otherwise noted.)

CHARACTERISTIC	SYMBOL	MIN	TYP	MAX	UNIT
Output Voltage ($T_j=+25^\circ C$)	V_o	11.76	12	12.24	Vdc
Line Regulation ($T_j=+25^\circ C$, $I_o=40mA$) $14.5V \leq V_i \leq 27V$ $16V \leq V_j \leq 27V$	REGline		120 100	250 200	mV
Load Regulation $T_j=+25^\circ C$, $1.0mA \leq I_o \leq 100mA$ $T_j=+25^\circ C$, $1.0mA \leq I_o \leq 40mA$	REGload		20 10	100 50	mV
Output Voltage $14.5V \leq V_i \leq 27V$, $1.0mA \leq I_o \leq 40mA$ $V_i=19V$, $1.0mA \leq I_o \leq 70mA$	V_o	11.66 11.66		12.34 12.34	Vdc
Input Bias Current ($T_j=+25^\circ C$) ($T_j=+125^\circ C$)	I_{IB}		4.2	6.5 6.0	mA
Input Bias Current Change $16V \leq V_i \leq 27V$ $1.0mA \leq I_o \leq 40mA$	ΔI_{IB}			1.5 0.2	mA
Output Noise Voltage ($T_a=+25^\circ C$, $10Hz \leq f \leq 100KHz$)	V_n		80		μV
Ripple Rejection ($I_o=40mA$, $f=120Hz$, $15V \leq V_i \leq 25V$, $T_j=+25^\circ C$)	RR	36	42		dB
Dropout Voltage ($T_j=+25^\circ C$)	V_i-V_o		1.7		Vdc

LM78L15/S ELECTRICAL CHARACTERISTICS :

($V_i=23V$, $I_o=40mA$, $C_i=0.33\mu F$, $C_o=0.1\mu F$, $0^\circ C < T_j < +125^\circ C$ unless otherwise noted.)

CHARACTERISTIC	SYMBOL	MIN	TYP	MAX	UNIT
Output Voltage ($T_j=+25^\circ C$)	V_o	14.7	15	15.3	Vdc
Line Regulation($T_j=+25^\circ C$, $I_o=40mA$) 17.5V $\leq V_i \leq 30V$ 20V $\leq V_i \leq 30V$	REGline		130 110	300 250	mV
Load Regulation $T_j=+25^\circ C$, $1.0mA \leq I_o \leq 100mA$ $T_j=+25^\circ C$, $1.0mA \leq I_o < 40mA$	REGload		25 12	150 75	mV
Output Voltage 17.5V $\leq V_i \leq 30V$, $1.0mA \leq I_o \leq 40mA$ $V_i=23V$, $1.0mA \leq I_o < 70mA$	V_o	14.55 14.55		15.45 15.45	Vdc
Input Bias Current ($T_j=+25^\circ C$) ($T_j=+125^\circ C$)	I_{IB}		4.4	6.5 6.0	mA
Input Bias Current Change 20V $\leq V_i \leq 30V$ $1.0mA \leq I_o \leq 40mA$	ΔI_{IB}			1.5 0.2	mA
Output Noise Voltage ($T_a=+25^\circ C$, $10Hz \leq f \leq 100KHz$)	V_n		90		μV
Ripple Rejection ($I_o=40mA$, $f=120Hz$, $18.5V \leq V_i \leq 28.5V$, $T_j=+25^\circ C$)	RR	33	39		dB
Dropout Voltage ($T_j=+25^\circ C$)	V_i-V_o		1.7		Vdc

LM78L18/S ELECTRICAL CHARACTERISTICS :

($V_i=27V$, $I_o=40mA$, $C_i=0.33\mu F$, $C_o=0.1\mu F$, $0^\circ C < T_j < +125^\circ C$ unless otherwise noted.)

CHARACTERISTIC	SYMBOL	MIN	TYP	MAX	UNIT
Output Voltage ($T_j=+25^\circ C$)	V_o	17.64	18	18.36	Vdc
Line Regulation($T_j=+25^\circ C$, $I_o=40mA$) 21.4V $\leq V_i \leq 33V$ 22V $\leq V_i \leq 33V$	REGline		32 27	325 275	mV
Load Regulation $T_j=+25^\circ C$, $1.0mA \leq I_o \leq 100mA$ $T_j=+25^\circ C$, $1.0mA \leq I_o \leq 40mA$	REGload		30 15	170 85	mV
Output Voltage 21.4V $\leq V_i < 33V$, $1.0mA \leq I_o \leq 40mA$ $V_i=27V$, $1.0mA \leq I_o < 70mA$	V_o	17.44 17.44		18.56 18.56	Vdc
Input Bias Current ($T_j=+25^\circ C$) ($T_j=+125^\circ C$)	I_{IB}		3.1	6.5 6.0	mA
Input Bias Current Change 22V $\leq V_i \leq 33V$ $1.0mA \leq I_o \leq 40mA$	ΔI_{IB}			1.5 0.2	mA
Output Noise Voltage ($T_a=+25^\circ C$, $10Hz \leq f \leq 100KHz$)	V_n		150		μV
Ripple Rejection ($I_o=40mA$, $f=120Hz$, $23V \leq V_i \leq 33V$, $T_j=+25^\circ C$)	RR	32	46		dB
Dropout Voltage ($T_j=+25^\circ C$)	V_i-V_o		1.7		Vdc

3719482 0001183 877

LM78L24/S ELECTRICAL CHARACTERISTICS :

($V_i=33V$, $I_o=40mA$, $C_i=0.33\mu F$, $C_o=0.1\mu F$, $0^\circ C < T_j < +125^\circ C$ unless otherwise noted.)

CHARACTERISTIC	SYMBOL	MIN	TYP	MAX	UNIT
Output Voltage ($T_j=+25^\circ C$)	V_o	23.52	24	24.48	Vdc
Line Regulation ($T_j=+25^\circ C$, $I_o=40mA$) $27.5V \leq V_i \leq 38V$ $28V \leq V_i \leq 38V$	REG _{line}		35 30	350 300	mV
Load Regulation $T_j=+25^\circ C$, $1.0mA \leq I_o \leq 100mA$ $T_j=+25^\circ C$, $1.0mA \leq I_o \leq 40mA$	REG _{load}		40 20	200 100	mV
Output Voltage $28V \leq V_i \leq 38V$, $1.0mA \leq I_o \leq 40mA$ $28V \leq V_i \leq 33V$, $1.0mA \leq I_o \leq 70mA$	V_o	23.32 23.32		24.68 24.68	Vdc
Input Bias Current ($T_j=+25^\circ C$) ($T_j=+125^\circ C$)	I_{IB}		3.1	6.5 6.0	mA
Input Bias Current Change $28V \leq V_i \leq 38V$ $1.0mA \leq I_o \leq 40mA$	ΔI_{IB}			1.5 0.2	mA
Output Noise Voltage ($T_a=+25^\circ C$, $10Hz \leq f \leq 100KHz$)	V_n		200		μV
Ripple Rejection ($I_o=40mA$, $f=120Hz$, $29V \leq V_i \leq 35V$, $T_j=+25^\circ C$)	RR	30	43		dB
Dropout Voltage ($T_j=+25^\circ C$)	$V_i - V_o$		1.7		Vdc

FIGURE 1-DROPOUT CHARACTERISTIC

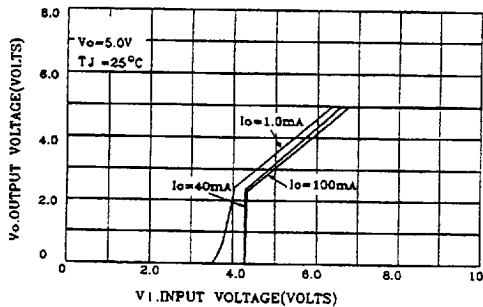

FIGURE 2-DROPOUT VOLTAGE versus JUNCTION TEMPERATURE

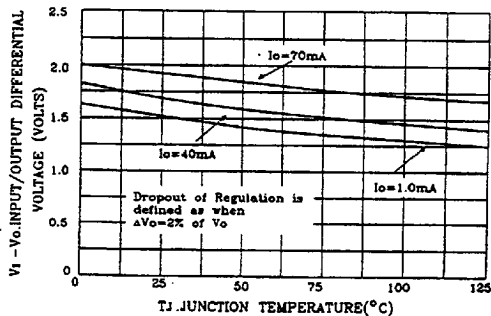

FIGURE 3-INPUT BIAS CURRENT versus AMBIENT TEMPERATURE

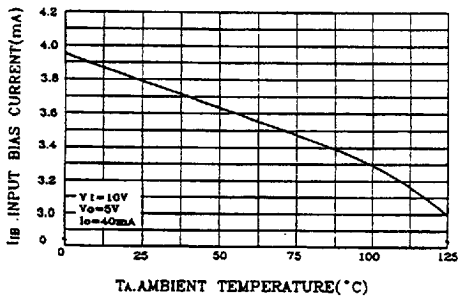

FIGURE 4-INPUT BIAS CURRENT versus INPUT VOLTAGE

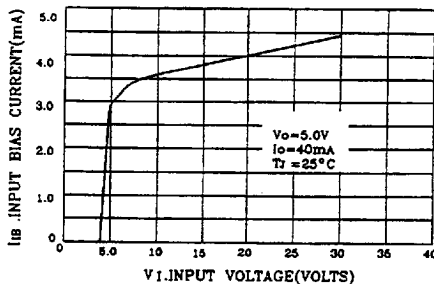
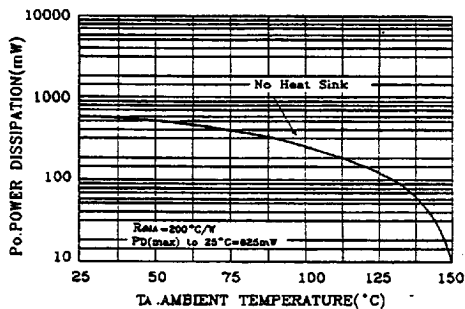

FIGURE 5-MAXIMUM AVERAGE POWER DISSIPATION versus AMBIENT TEMPERATURE - TO-92 Type Package



3719482 0001185 64T