

IRHQ6110
RADIATION HARDENED 100V, Combination 2N-2P-CHANNEL
POWER MOSFET
SURFACE MOUNT (LCC-28)

RAD-Hard™ HEXFET®
MOSFET TECHNOLOGY

Product Summary

| Part Number | Radiation Level | RDS(on) | Id | CHANNEL |
|-------------|-----------------|---------|-------|---------|
| IRHQ6110 | 100K Rads (Si) | 0.6Ω | 3.0A | N |
| IRHQ63110 | 300K Rads (Si) | 0.6Ω | 3.0A | N |
| IRHQ6110 | 100K Rads (Si) | 1.1Ω | -2.3A | P |
| IRHQ63110 | 300K Rads (Si) | 1.1Ω | -2.3A | P |

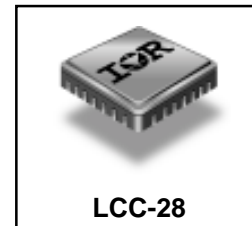

International Rectifier's RAD-Hard™ HEXFET® MOSFET Technology provides high performance power MOSFETs for space applications. This technology has over a decade of proven performance and reliability in satellite applications. These devices have been characterized for both Total Dose and Single Event Effects (SEE). The combination of low RDS(on) and low gate charge reduces the power losses in switching applications such as DC to DC converters and motor control. These devices retain all of the well established advantages of MOSFETs such as voltage control, fast switching, ease of paralleling and temperature stability of electrical parameters.

Features:

- Single Event Effect (SEE) Hardened
- Low RDS(on)
- Low Total Gate Charge
- Proton Tolerant
- Simple Drive Requirements
- Ease of Paralleling
- Hermetically Sealed
- Ceramic Package
- Surface Mount
- Light Weight

Absolute Maximum Ratings

Pre-Irradiation

| | Parameter | N-Channel | P-Channel | Units |
|----------------------------|-------------------------------|----------------|-----------|-------|
| ID @ VGS = 12V, TC = 25°C | Continuous Drain Current | 3.0 | -2.3 | A |
| ID @ VGS = 12V, TC = 100°C | Continuous Drain Current | 1.9 | -1.5 | |
| IDM | Pulsed Drain Current ① | 12 | -9.2 | |
| PD @ TC = 25°C | Max. Power Dissipation | 12 | 12 | W |
| | Linear Derating Factor | 0.1 | 0.1 | W/°C |
| VGS | Gate-to-Source Voltage | ±20 | ±20 | V |
| EAS | Single Pulse Avalanche Energy | 85 ② | 75 ③ | mJ |
| IAR | Avalanche Current ① | 3.0 | -2.3 | A |
| EAR | Repetitive Avalanche Energy ① | 1.2 | 1.2 | mJ |
| dv/dt | Peak Diode Recovery dv/dt | 3.0 ③ | 9.0 ④ | V/ns |
| TJ | Operating Junction | -55 to 150 | | °C |
| TSTG | Storage Temperature Range | | | |
| | Pckg. Mounting Surface Temp. | 300 (for 5s) | | |
| | Weight | 0.89 (Typical) | | g |

For footnotes refer to the last page

Electrical Characteristics For Each N-Channel Device @ T_J = 25°C (Unless Otherwise Specified)

| | Parameter | Min | Typ | Max | Units | Test Conditions |
|-------------------------------------|--|-----|------|------|-------|---|
| BV _{DSS} | Drain-to-Source Breakdown Voltage | 100 | — | — | V | V _{GS} = 0V, I _D = 1.0mA |
| ΔBV _{DSS} /ΔT _J | Temperature Coefficient of Breakdown Voltage | — | 0.11 | — | V/°C | Reference to 25°C, I _D = 1.0mA |
| R _{DS(on)} | Static Drain-to-Source On-State Resistance | — | — | 0.62 | Ω | V _{GS} = 12V, I _D = 3.0A ④ |
| | | — | — | 0.60 | | V _{GS} = 12V, I _D = 1.9A |
| V _{GS(th)} | Gate Threshold Voltage | 2.0 | — | 4.0 | V | V _{DS} = V _{GS} , I _D = 1.0mA |
| g _{fs} | Forward Transconductance | 1.4 | — | — | S (r) | V _{DS} > 15V, I _{DS} = 1.9A ④ |
| I _{DSS} | Zero Gate Voltage Drain Current | — | — | 25 | μA | V _{DS} = 80V, V _{GS} = 0V |
| | | — | — | 250 | | V _{DS} = 80V, V _{GS} = 0V, T _J = 125°C |
| I _{GSS} | Gate-to-Source Leakage Forward | — | — | 100 | nA | V _{GS} = 20V |
| I _{GSS} | Gate-to-Source Leakage Reverse | — | — | -100 | | V _{GS} = -20V |
| Q _g | Total Gate Charge | — | — | 17 | nC | V _{GS} = 12V, I _D = 3.0A V _{DS} = 50V |
| Q _{gs} | Gate-to-Source Charge | — | — | 4.0 | | |
| Q _{gd} | Gate-to-Drain ("Miller") Charge | — | — | 5.5 | | |
| t _{d(on)} | Turn-On Delay Time | — | — | 13 | ns | V _{DD} = 50V, I _D = 3.0A, V _{GS} = 12V, R _G = 7.5Ω |
| t _r | Rise Time | — | — | 16 | | |
| t _{d(off)} | Turn-Off Delay Time | — | — | 23 | | |
| t _f | Fall Time | — | — | 15 | | |
| LS + LD | Total Inductance | — | 6.1 | — | nH | Measured from the center of drain pad to center of source pad |
| C _{iss} | Input Capacitance | — | 270 | — | pF | V _{GS} = 0V, V _{DS} = 25V f = 1.0MHz |
| C _{oss} | Output Capacitance | — | 110 | — | | |
| C _{rss} | Reverse Transfer Capacitance | — | 23 | — | | |

Source-Drain Diode Ratings and Characteristics

| | Parameter | Min | Typ | Max | Units | Test Conditions |
|-----------------|--|---|-----|-----|-------|--|
| I _S | Continuous Source Current (Body Diode) | — | — | 3.0 | A | T _J = 25°C, I _S = 3.0A, V _{GS} = 0V ④ |
| I _{SM} | Pulse Source Current (Body Diode) ① | — | — | 12 | | |
| V _{SD} | Diode Forward Voltage | — | — | 1.2 | V | T _J = 25°C, I _F = 3.0A, di/dt ≤ 100A/μs |
| t _{rr} | Reverse Recovery Time | — | — | 173 | nS | V _{DD} ≤ 25V ④ |
| Q _{RR} | Reverse Recovery Charge | — | — | 863 | nC | |
| t _{on} | Forward Turn-On Time | Intrinsic turn-on time is negligible. Turn-on speed is substantially controlled by LS + LD. | | | | |

Thermal Resistance

| | Parameter | Min | Typ | Max | Units | Test Conditions |
|-------------------|------------------|-----|-----|------|-------|-----------------|
| R _{thJC} | Junction-to-Case | — | — | 10.4 | °C/W | |

Note: Corresponding Spice and Saber models are available on the G&S Website.

For footnotes refer to the last page

Electrical Characteristics For Each P-Channel Device @ T_j = 25°C (Unless Otherwise Specified)

| | Parameter | Min | Typ | Max | Units | Test Conditions |
|-------------------------------------|--|------|-------|------|-------|--|
| BV _{DSS} | Drain-to-Source Breakdown Voltage | -100 | — | — | V | V _{GS} = 0V, I _D = -1.0mA |
| ΔBV _{DSS} /ΔT _J | Temperature Coefficient of Breakdown Voltage | — | -0.10 | — | V/°C | Reference to 25°C, I _D = -1.0mA |
| R _{DS(on)} | Static Drain-to-Source On-State Resistance | — | — | 1.1 | Ω | V _{GS} = -12V, I _D = -1.5A ④ |
| V _{GS(th)} | Gate Threshold Voltage | -2.0 | — | -4.0 | V | V _{DS} = V _{GS} , I _D = -1.0mA |
| g _{fs} | Forward Transconductance | 1.2 | — | — | S (r) | V _{DS} > -15V, I _{DS} = -1.5A ④ |
| I _{DSS} | Zero Gate Voltage Drain Current | — | — | -25 | μA | V _{DS} = -80V, V _{GS} = 0V |
| | | — | — | -250 | | V _{DS} = -80V, V _{GS} = 0V, T _J = 125°C |
| I _{GSS} | Gate-to-Source Leakage Forward | — | — | -100 | nA | V _{GS} = -20V |
| I _{GSS} | Gate-to-Source Leakage Reverse | — | — | 100 | | V _{GS} = 20V |
| Q _g | Total Gate Charge | — | — | 16 | nC | V _{GS} = -12V, I _D = -2.3A |
| Q _{gs} | Gate-to-Source Charge | — | — | 4.3 | | V _{DS} = -50V |
| Q _{gd} | Gate-to-Drain ('Miller') Charge | — | — | 3.3 | | |
| t _{d(on)} | Turn-On Delay Time | — | — | 21 | ns | V _{DD} = -50V, I _D = -2.3A, V _{GS} = -12V, R _G = 7.5Ω |
| t _r | Rise Time | — | — | 17 | | |
| t _{d(off)} | Turn-Off Delay Time | — | — | 32 | | |
| t _f | Fall Time | — | — | 32 | | |
| L _S + L _D | Total Inductance | — | 6.1 | — | nH | Measured from the center of drain pad to center of source pad |
| C _{iss} | Input Capacitance | — | 285 | — | pF | V _{GS} = 0V, V _{DS} = -25V f = 1.0MHz |
| C _{oss} | Output Capacitance | — | 90 | — | | |
| C _{rss} | Reverse Transfer Capacitance | — | 13 | — | | |

Source-Drain Diode Ratings and Characteristics

| | Parameter | Min | Typ | Max | Units | Test Conditions |
|-----------------|--|--|-----|------|-------|---|
| I _S | Continuous Source Current (Body Diode) | — | — | -2.3 | A | |
| I _{SM} | Pulse Source Current (Body Diode) ① | — | — | -9.2 | | |
| V _{SD} | Diode Forward Voltage | — | — | -2.5 | V | T _j = 25°C, I _S = -2.3A, V _{GS} = 0V ④ |
| t _{rr} | Reverse Recovery Time | — | — | 138 | nS | T _j = 25°C, I _F = -2.3A, di/dt ≤ 100A/μs |
| Q _{RR} | Reverse Recovery Charge | — | — | 555 | nC | V _{DD} ≤ -25V ④ |
| t _{on} | Forward Turn-On Time | Intrinsic turn-on time is negligible. Turn-on speed is substantially controlled by L _S + L _D . | | | | |

Thermal Resistance

| | Parameter | Min | Typ | Max | Units | Test Conditions |
|-------------------|------------------|-----|-----|------|-------|-----------------|
| R _{thJC} | Junction-to-Case | — | — | 10.4 | °C/W | |

For footnotes refer to the last page

International Rectifier Radiation Hardened MOSFETs are tested to verify their radiation hardness capability. The hardness assurance program at International Rectifier is comprised of two radiation environments. Every manufacturing lot is tested for total ionizing dose (per notes 5 and 6) using the TO-3 package. Both pre- and post-irradiation performance are tested and specified using the same drive circuitry and test conditions in order to provide a direct comparison.

Table 1. Electrical Characteristics For Each N-Channel Device @ Tj = 25°C, Post Total Dose Irradiation ⑤⑥

| | Parameter | 100K Rads(Si) ¹ | | 300K to 1000K Rads (Si) ² | | Units | Test Conditions |
|---------------------|--|----------------------------|-------|--------------------------------------|-------|-------|--|
| | | Min | Max | Min | Max | | |
| BV _{DSS} | Drain-to-Source Breakdown Voltage | 100 | — | 100 | — | V | V _{GS} = 0V, I _D = 1.0mA |
| V _{GS(th)} | Gate Threshold Voltage | 2.0 | 4.0 | 1.25 | 4.5 | | V _{GS} = V _{DS} , I _D = 1.0mA |
| I _{GSS} | Gate-to-Source Leakage Forward | — | 100 | — | 100 | nA | V _{GS} = 20V |
| I _{GSS} | Gate-to-Source Leakage Reverse | — | -100 | — | -100 | | V _{GS} = -20 V |
| I _{DSS} | Zero Gate Voltage Drain Current | — | 25 | — | 25 | μA | V _{DS} = 80V, V _{GS} = 0V |
| R _{DS(on)} | Static Drain-to-Source ④ On-State Resistance (TO-39) | — | 0.556 | — | 0.706 | Ω | V _{GS} = 12V, I _D = 1.9A |
| R _{DS(on)} | Static Drain-to-Source ④ On-State Resistance (LCC-28) | — | 0.60 | — | 0.75 | Ω | V _{GS} = 12V, I _D = 1.9A |
| V _{SD} | Diode Forward Voltage ④ | — | 1.2 | — | 1.2 | V | V _{GS} = 0V, I _S = 3.0A |

1. Part number IRHQ6110
2. Part number IRHQ63110

International Rectifier radiation hardened MOSFETs have been characterized in heavy ion environment for Single Event Effects (SEE). Single Event Effects characterization is illustrated in Fig. a and Table 2.

Table 2. Single Event Effect Safe Operating Area

| Ion | LET MeV/(mg/cm ²) | Energy (MeV) | Range (μm) | V _{DS} (V) | | | | |
|-----|----------------------------------|-----------------|---------------|------------------------|-------------------------|--------------------------|--------------------------|--------------------------|
| | | | | @ V _{GS} = 0V | @ V _{GS} = -5V | @ V _{GS} = -10V | @ V _{GS} = -15V | @ V _{GS} = -20V |
| Cu | 28.0 | 285 | 43.0 | 100 | 100 | 100 | 100 | 70 |
| Br | 36.8 | 305 | 39.0 | 100 | 80 | 70 | 50 | — |
| I | 59.8 | 343 | 32.6 | 50 | 40 | 35 | — | — |

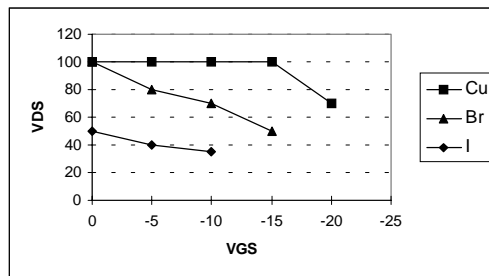

Fig a. Single Event Effect, Safe Operating Area

For footnotes refer to the last page

Pre-Irradiation

IRHQ6110

International Rectifier Radiation Hardened MOSFETs are tested to verify their radiation hardness capability. The hardness assurance program at International Rectifier is comprised of two radiation environments. Every manufacturing lot is tested for total ionizing dose (per notes 5 and 6) using the TO-3 package. Both pre- and post-irradiation performance are tested and specified using the same drive circuitry and test conditions in order to provide a direct comparison.

Table 1. Electrical Characteristics For Each P-Channel Device @ Tj = 25°C, Post Total Dose Irradiation ⑤⑥

| | Parameter | 100K Rads (Si) ¹ | | 300K to 1000K Rads (Si) ² | | Units | Test Conditions |
|---------------------|--|-----------------------------|-------|--------------------------------------|-------|-------|---|
| | | Min | Max | Min | Max | | |
| BV _{DSS} | Drain-to-Source Breakdown Voltage | -100 | — | -100 | — | V | V _{GS} = 0V, I _D = -1.0mA |
| V _{GS(th)} | Gate Threshold Voltage | -2.0 | -4.0 | -2.0 | -5.0 | | V _{GS} = V _{DS} , I _D = -1.0mA |
| I _{GSS} | Gate-to-Source Leakage Forward | — | -100 | — | -100 | nA | V _{GS} = -20V |
| I _{GSS} | Gate-to-Source Leakage Reverse | — | 100 | — | 100 | | V _{GS} = 20 V |
| I _{DSS} | Zero Gate Voltage Drain Current | — | -25 | — | 25 | μA | V _{DS} = -80V, V _{GS} = 0V |
| R _{DS(on)} | Static Drain-to-Source ④ On-State Resistance (TO-39) | — | 1.056 | — | 1.056 | Ω | V _{GS} = -12V, I _D = -1.5A |
| R _{DS(on)} | Static Drain-to-Source ④ On-State Resistance (LCC-28) | — | 1.1 | — | 1.1 | Ω | V _{GS} = -12V, I _D = -1.5A |
| V _{SD} | Diode Forward Voltage ④ | — | -2.5 | — | -2.5 | V | V _{GS} = 0V, I _S = -2.3A |

1. Part numbers IRHQ6110

2. Part number IRHQ63110

International Rectifier radiation hardened MOSFETs have been characterized in heavy ion environment for Single Event Effects (SEE). Single Event Effects characterization is illustrated in Fig. a and Table 2.

Table 2. Single Event Effect Safe Operating Area

| Ion | LET MeV/(mg/cm ²) | Energy (MeV) | Range (μm) | V _{DS} (V) | | | | |
|-----|----------------------------------|-----------------|---------------|------------------------|------------------------|-------------------------|-------------------------|-------------------------|
| | | | | @ V _{GS} = 0V | @ V _{GS} = 5V | @ V _{GS} = 10V | @ V _{GS} = 15V | @ V _{GS} = 20V |
| Cu | 28.0 | 285 | 43.0 | -100 | -100 | -100 | -70 | -60 |
| Br | 36.8 | 305 | 39.0 | -100 | -100 | -70 | -50 | -40 |
| I | 59.8 | 343 | 32.6 | -60 | — | — | — | — |

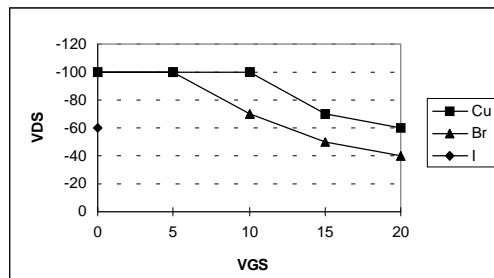

Fig a. Single Event Effect, Safe Operating Area

For footnotes refer to the last page

N-Channel
Q1,Q4

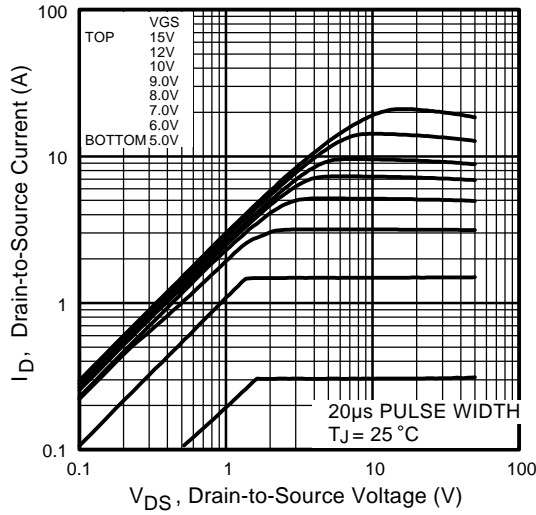

Fig 1. Typical Output Characteristics

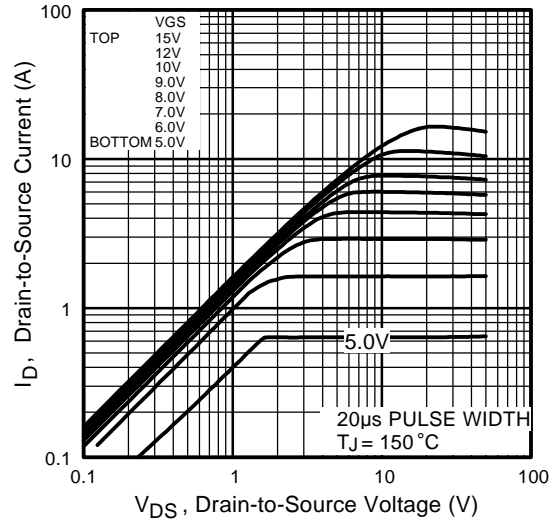

Fig 2. Typical Output Characteristics

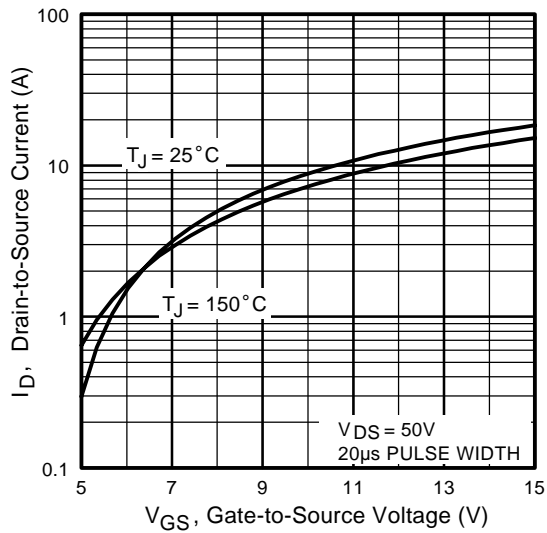

Fig 3. Typical Transfer Characteristics

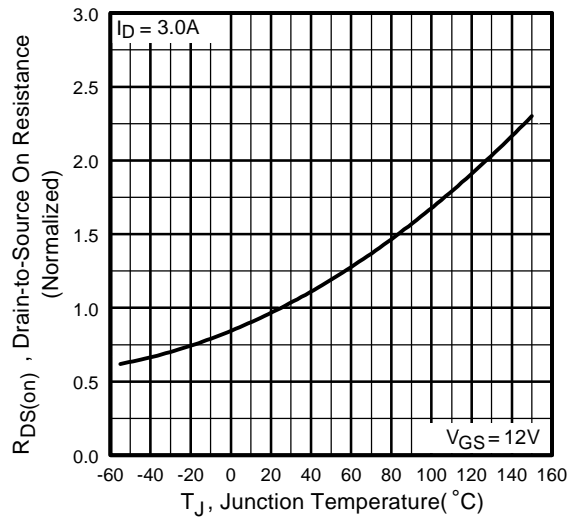

Fig 4. Normalized On-Resistance Vs. Temperature

N-Channel
Q1,Q4

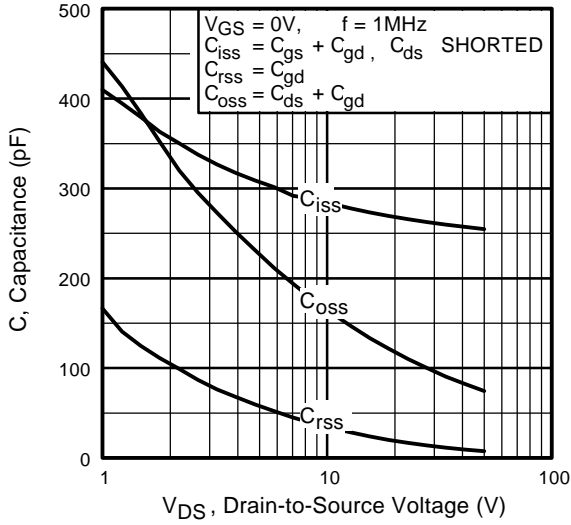

Fig 5. Typical Capacitance Vs. Drain-to-Source Voltage

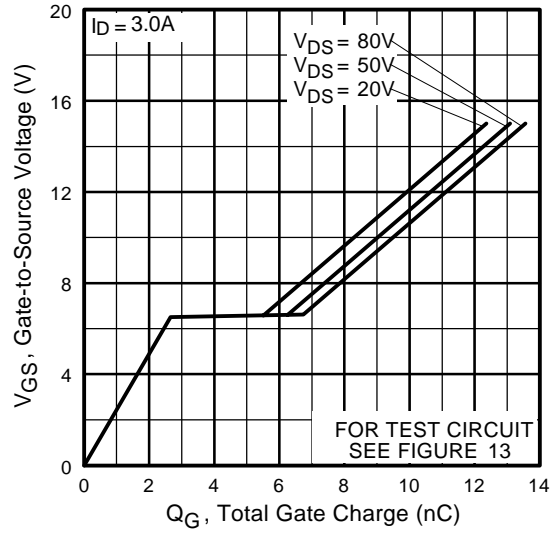

Fig 6. Typical Gate Charge Vs. Gate-to-Source Voltage

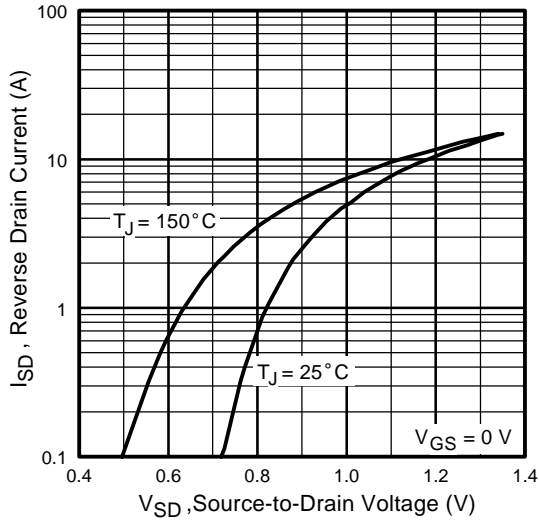

Fig 7. Typical Source-Drain Diode Forward Voltage

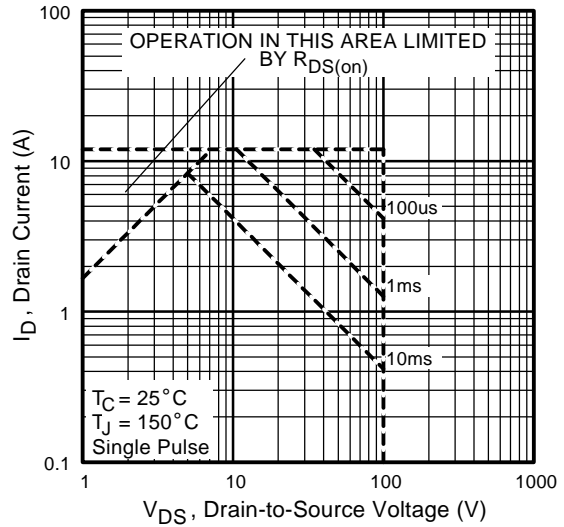

Fig 8. Maximum Safe Operating Area

N-Channel
Q1,Q4

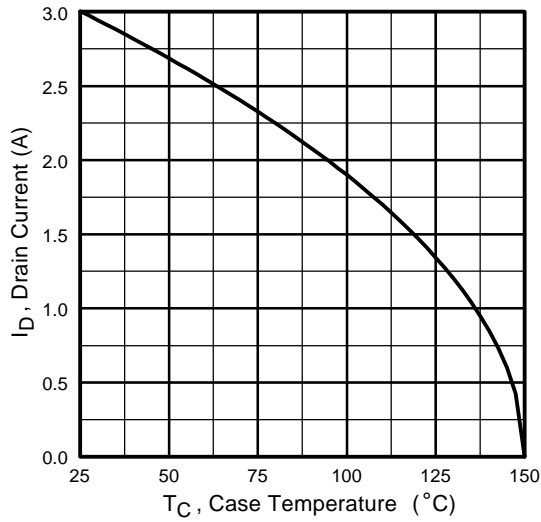

Fig 9. Maximum Drain Current Vs. Case Temperature

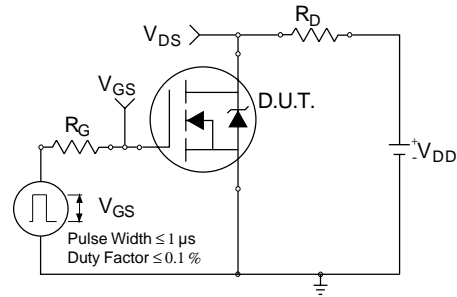

Fig 10a. Switching Time Test Circuit

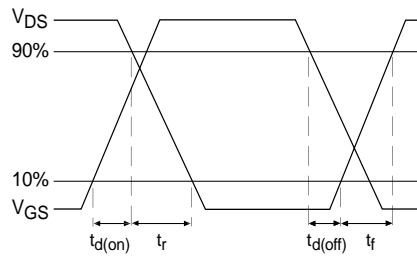

Fig 10b. Switching Time Waveforms

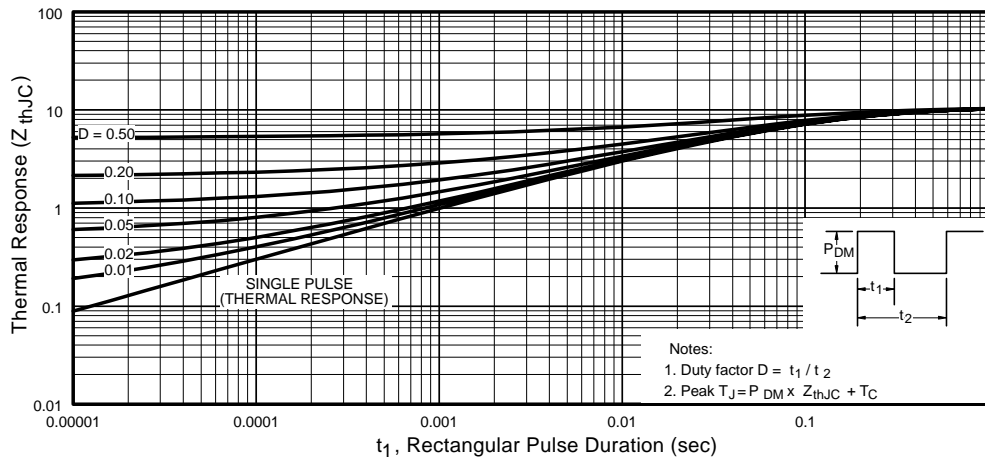

Fig 11. Maximum Effective Transient Thermal Impedance, Junction-to-Ambient

**N-Channel
Q1,Q4**

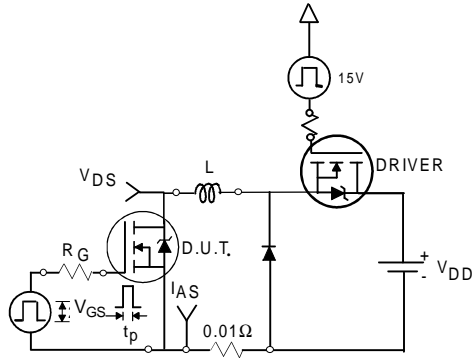

Fig 12a. Unclamped Inductive Test Circuit

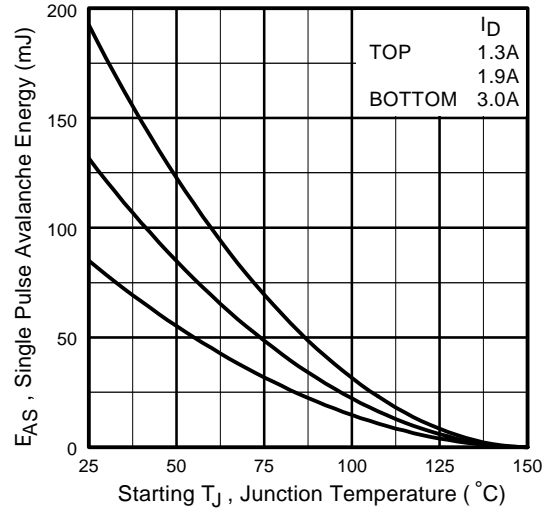

Fig 12c. Maximum Avalanche Energy Vs. Drain Current

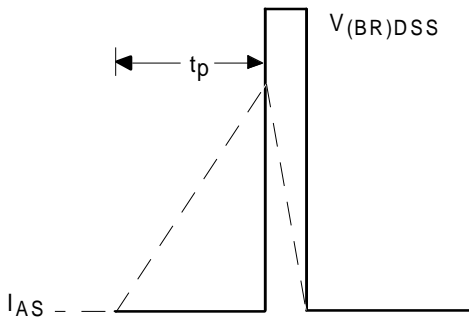

Fig 12b. Unclamped Inductive Waveforms

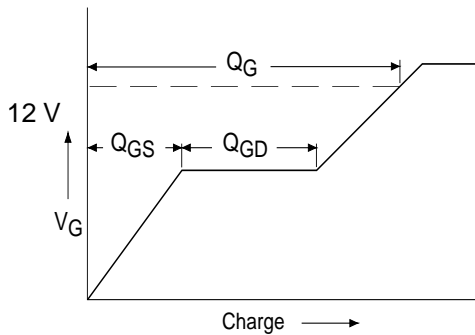

Fig 13a. Basic Gate Charge Waveform

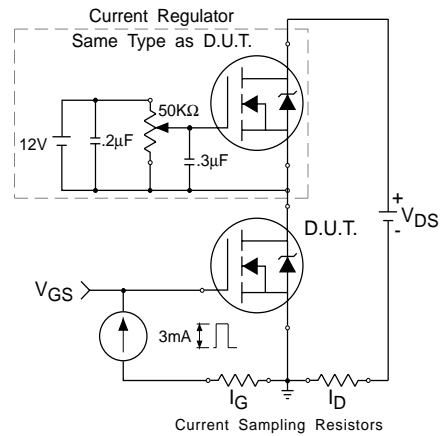

Fig 13b. Gate Charge Test Circuit

**P-Channel
Q2,Q3**

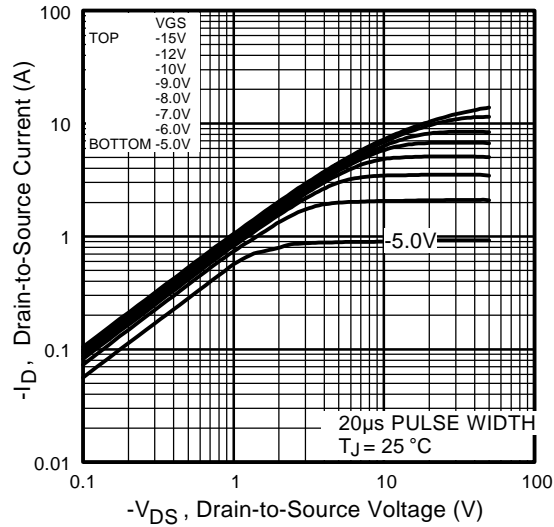

Fig 1. Typical Output Characteristics

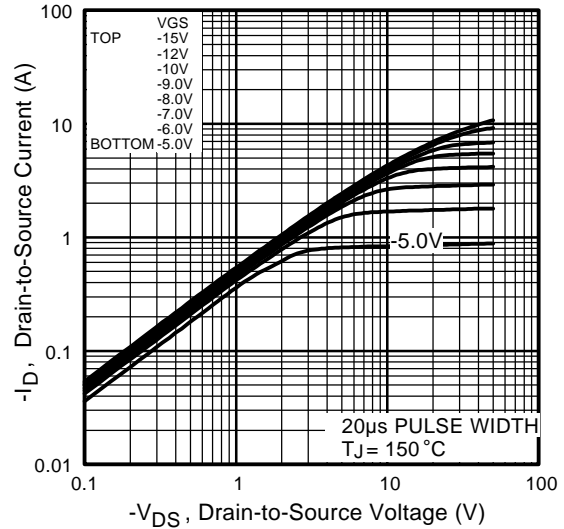

Fig 2. Typical Output Characteristics

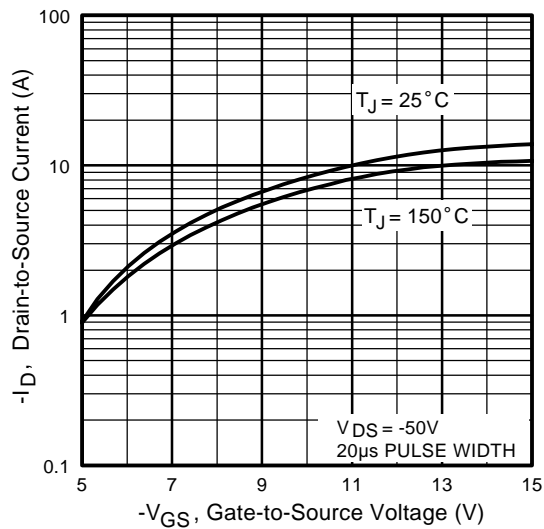

Fig 3. Typical Transfer Characteristics

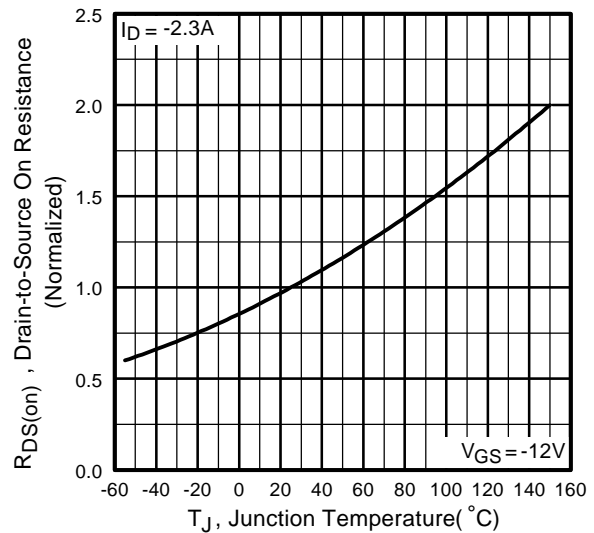

Fig 4. Normalized On-Resistance Vs. Temperature

**P-Channel
Q2,Q3**

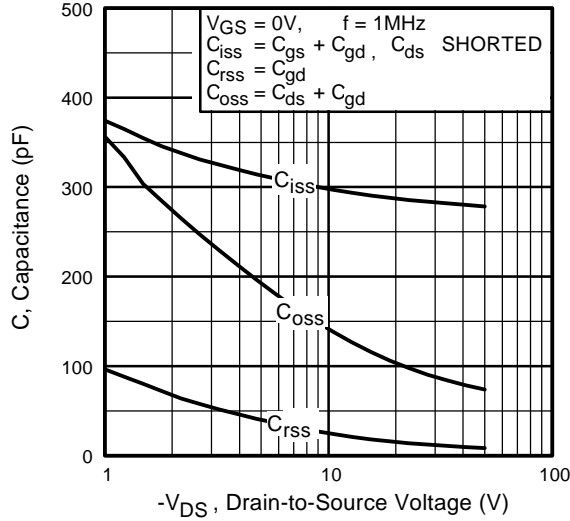

Fig 5. Typical Capacitance Vs. Drain-to-Source Voltage

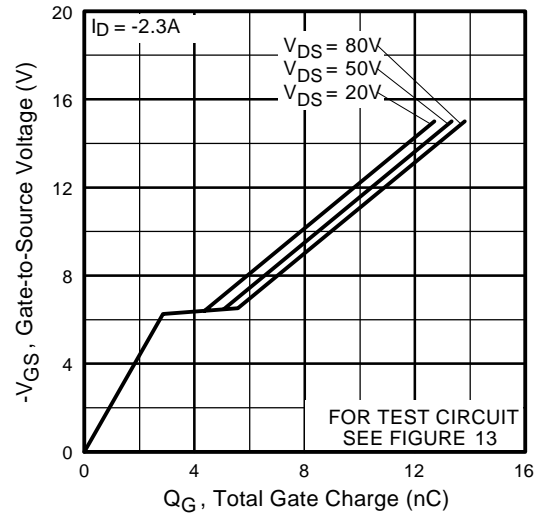

Fig 6. Typical Gate Charge Vs. Gate-to-Source Voltage

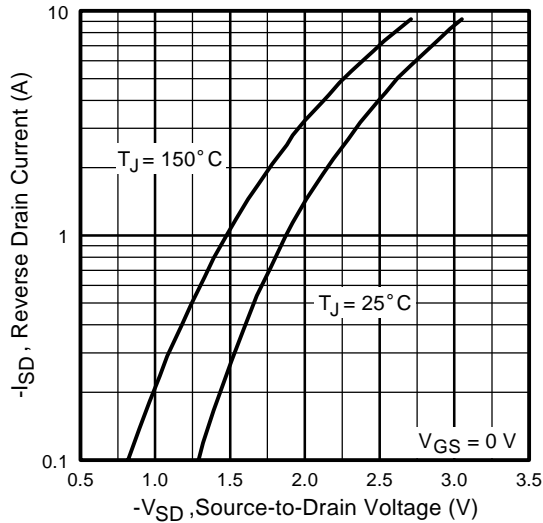

Fig 7. Typical Source-Drain Diode Forward Voltage

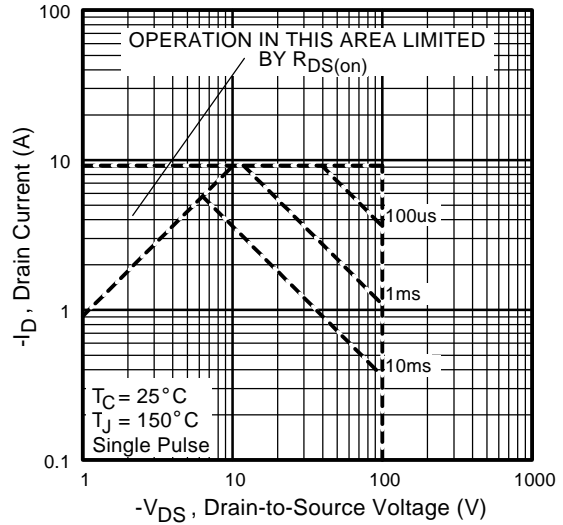

Fig 8. Maximum Safe Operating Area

P-Channel
Q2,Q3

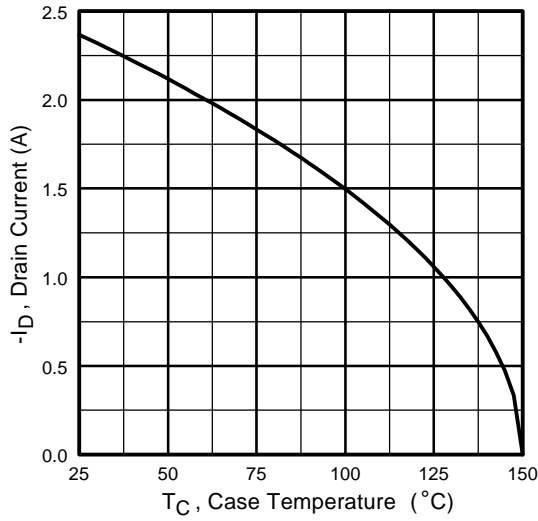

Fig 9. Maximum Drain Current Vs. Case Temperature

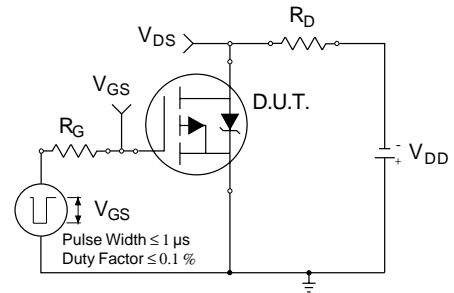

Fig 10a. Switching Time Test Circuit

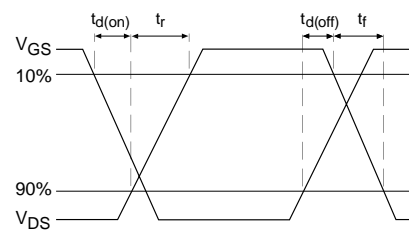

Fig 10b. Switching Time Waveforms

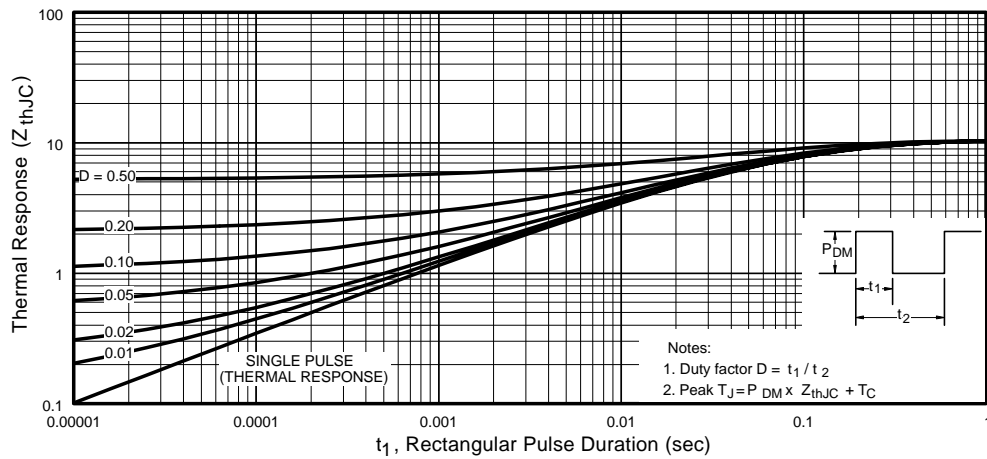

Fig 11. Maximum Effective Transient Thermal Impedance, Junction-to-Ambient

**P-Channel
Q2,Q3**

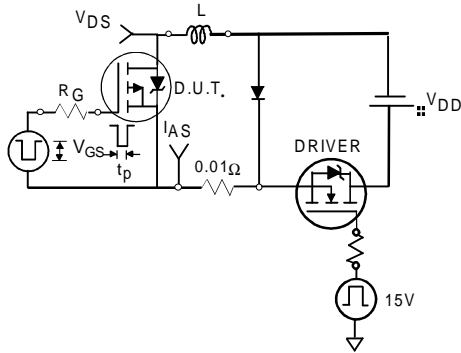

Fig 12a. Unclamped Inductive Test Circuit

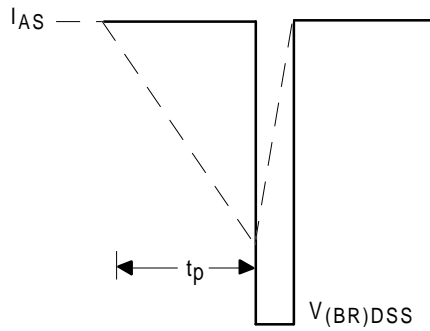

Fig 12b. Unclamped Inductive Waveforms

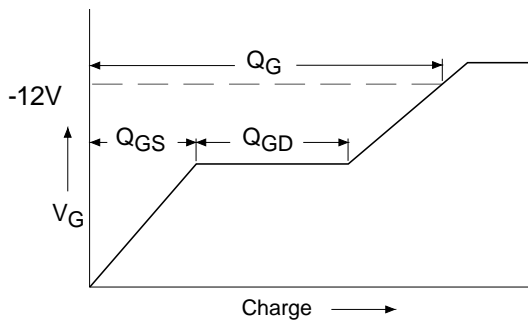

Fig 13a. Basic Gate Charge Waveform

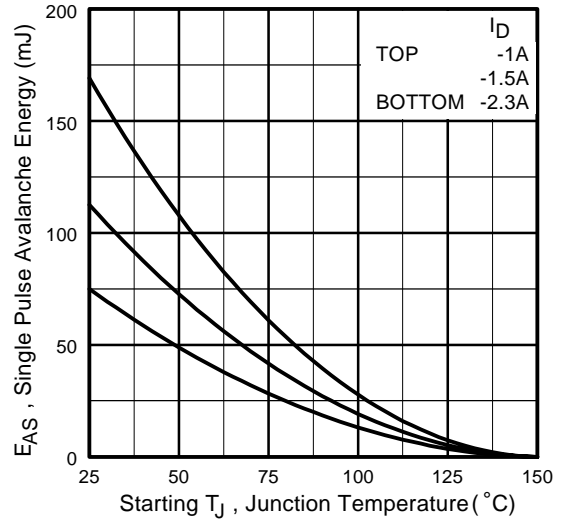

Fig 12c. Maximum Avalanche Energy Vs. Drain Current

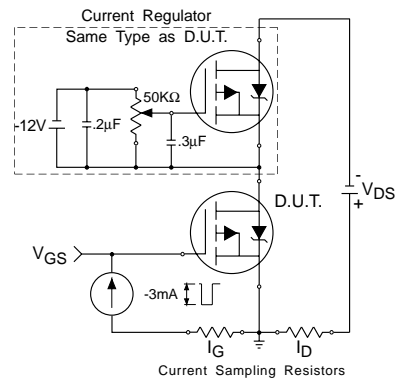

Fig 13b. Gate Charge Test Circuit

IRHQ6110

Pre-Irradiation

Footnotes:

- ① Repetitive Rating; Pulse width limited by maximum junction temperature.
- ② $V_{DD} = 25V$, starting $T_J = 25^\circ C$, $L = 18.7mH$, Peak $I_L = 3.0A$, $V_{GS} = 12V$
- ③ $I_{SD} \leq 3.0A$, $di/dt \leq 165A/\mu s$, $V_{DD} \leq 100V$, $T_J \leq 150^\circ C$
- ④ Pulse width $\leq 300 \mu s$; Duty Cycle $\leq 2\%$
- ⑤ **Total Dose Irradiation with VGS Bias.**
12 volt V_{GS} applied and $V_{DS} = 0$ during irradiation per MIL-STD-750, method 1019, condition A
- ⑥ **Total Dose Irradiation with VDS Bias.**
80 volt V_{DS} applied and $V_{GS} = 0$ during irradiation per MIL-STD-750, method 1019, condition A
- ⑦ $V_{DD} = -25V$, starting $T_J = 25^\circ C$, $L = 28.4mH$, Peak $I_L = -2.3A$, $V_{GS} = -12V$
- ⑧ $I_{SD} \leq -2.3A$, $di/dt \leq -244A/\mu s$, $V_{DD} \leq -100V$, $T_J \leq 150^\circ C$

Case Outline and Dimensions — LCC-28

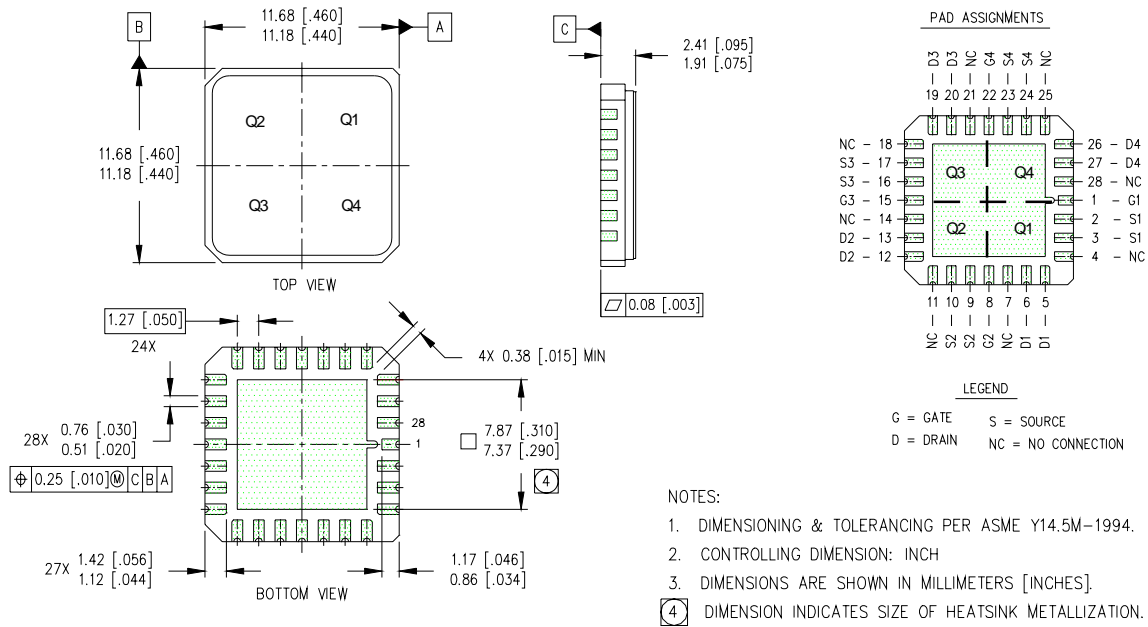

IR WORLD HEADQUARTERS: 233 Kansas St., El Segundo, California 90245, USA Tel: (310) 252-7105
TAC Fax: (310) 252-7903

Visit us at www.irf.com for sales contact information.
Data and specifications subject to change without notice. 07/01