



PD57018 PD57018S

RF POWER TRANSISTORS The *LdmoST* Plastic FAMILY

N-CHANNEL ENHANCEMENT-MODE LATERAL MOSFETs

- EXCELLENT THERMAL STABILITY
- COMMON SOURCE CONFIGURATION
- $P_{OUT} = 18\text{ W}$ WITH 16.5 dB gain @ 945 MHz / 28V
- NEW RF PLASTIC PACKAGE

DESCRIPTION

The PD57018 is a common source N-Channel, enhancement-mode lateral Field-Effect RF power transistor. It is designed for high gain, broad band commercial and industrial applications. It operates at 28V in common source mode at frequencies of up to 1 GHz. PD57018 boasts the excellent gain, linearity and reliability of ST's latest LDMOS technology mounted in the first true SMD plastic RF power package, PowerSO-10RF. PD57018's superior linearity performance makes it an ideal solution for base station applications.

The PowerSO-10 plastic package, designed to offer high reliability, is the first ST JEDEC approved, high power SMD package. It has been specially optimized for RF needs and offers excellent RF performances and ease of assembly.

Mounting recommendations are available in www.st.com/rf/ (look for application note AN1294)

ABSOLUTE MAXIMUM RATINGS ($T_{CASE} = 25^{\circ}\text{C}$)

Symbol	Parameter	Value	Unit
$V_{(BR)DSS}$	Drain-Source Voltage	65	V
V_{GS}	Gate-Source Voltage	± 20	V
I_D	Drain Current	2.5	A
P_{DISS}	Power Dissipation (@ $T_c = 70^{\circ}\text{C}$)	31.7	W
T_j	Max. Operating Junction Temperature	165	$^{\circ}\text{C}$
T_{STG}	Storage Temperature	-65 to +150	$^{\circ}\text{C}$

THERMAL DATA

$R_{th(j-c)}$	Junction -Case Thermal Resistance	3.0	$^{\circ}\text{C/W}$
---------------	-----------------------------------	-----	----------------------

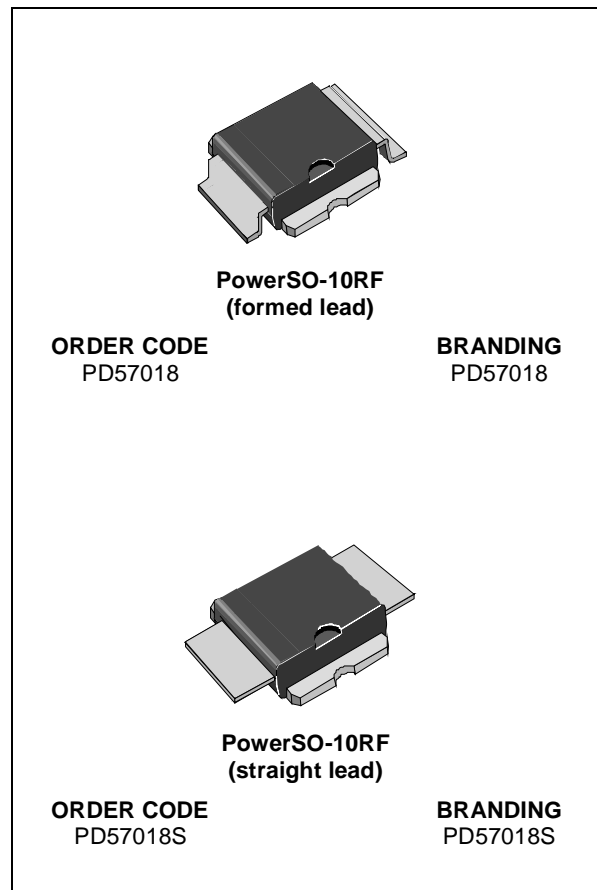

PD57018 - PD57018S

ELECTRICAL SPECIFICATION ($T_{CASE} = 25^{\circ}C$)

STATIC

Symbol	Test Conditions		Min.	Typ.	Max.	Unit
$V_{(BR)DSS}$	$V_{GS} = 0 V$	$I_{DS} = 10 mA$	65			V
I_{DSS}	$V_{GS} = 0 V$	$V_{DS} = 28 V$			1	μA
I_{GSS}	$V_{GS} = 20 V$	$V_{DS} = 0 V$			1	μA
$V_{GS(Q)}$	$V_{DS} = 28 V$	$I_D = 100 mA$	2.0		5.0	V
$V_{DS(ON)}$	$V_{GS} = 10 V$	$I_D = 1.25 A$			0.9	V
g_{FS}	$V_{DS} = 10 V$	$I_D = 1 A$		1		mho
C_{ISS}	$V_{GS} = 0 V$	$V_{DS} = 28 V$		34.5		pF
C_{OSS}	$V_{GS} = 0 V$	$V_{DS} = 28 V$		21		pF
C_{RSS}	$V_{GS} = 0 V$	$V_{DS} = 28 V$		1.3		pF

DYNAMIC

Symbol	Test Conditions		Min.	Typ.	Max.	Unit
P_{OUT}	$V_{DD} = 28 V$	$I_{DQ} = 100 mA$ $f = 945 MHz$	18			W
G_{PS}	$V_{DD} = 28 V$	$I_{DQ} = 100 mA$ $P_{OUT} = 18 W$ $f = 945 MHz$	14	16.5		dB
η_D	$V_{DD} = 28 V$	$I_{DQ} = 100 mA$ $P_{OUT} = 18 W$ $f = 945 MHz$	50	53		%
Load mismatch	$V_{DD} = 28 V$	$I_{DQ} = 100 mA$ $P_{OUT} = 18 W$ $f = 945 MHz$ ALL PHASE ANGLES	10:1			VSWR

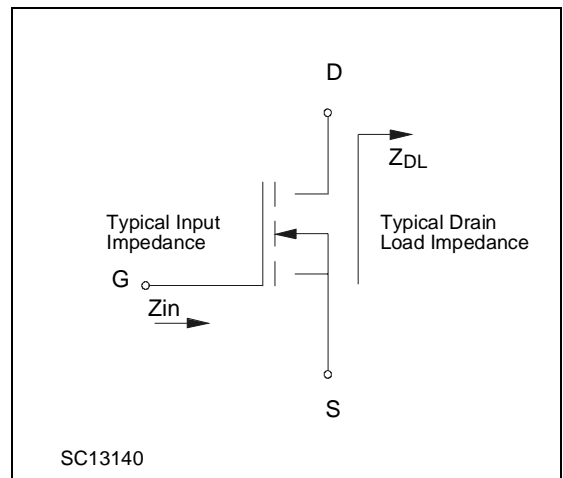
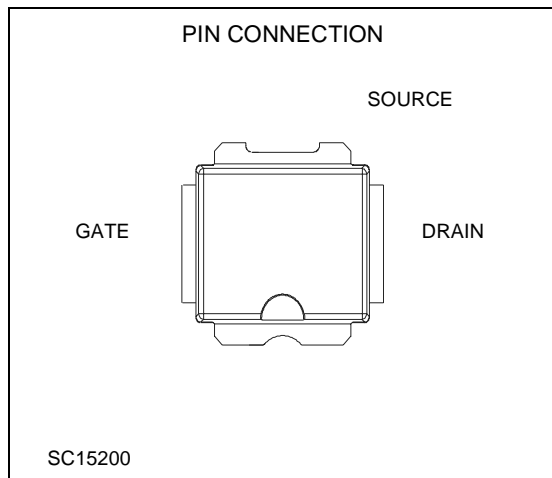

IMPEDANCE DATA

PD57018

FREQ. MHz	$Z_{IN} (\Omega)$	$Z_{DL}(\Omega)$
925	.52 - j 1.75	3.04 + j .10
945	.49 - j 2.38	3.14 + j .76
960	.48 - j 2.36	3.12 + j .27

IMPEDANCE DATA

PD57018S

FREQ. MHz	$Z_{IN} (\Omega)$	$Z_{DL}(\Omega)$
925	.35 - j .53	1.92 + j 4.13
945	.53 - j .86	2.03 + j 2.81
960	.50 - j .52	2.04 + j 2.57

TYPICAL PERFORMANCE

Capacitance vs. Drain Voltage

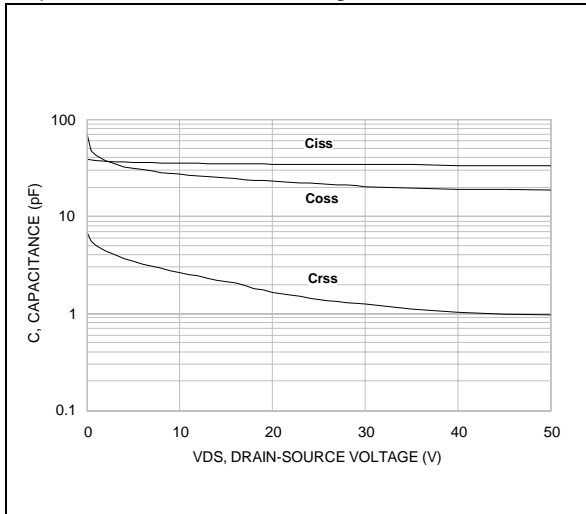

Drain Current vs. Gate Voltage

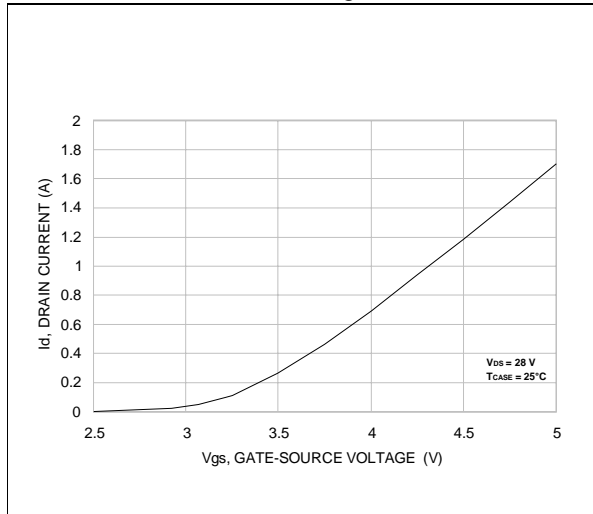

Gate-Source Voltage vs. Case Temperature

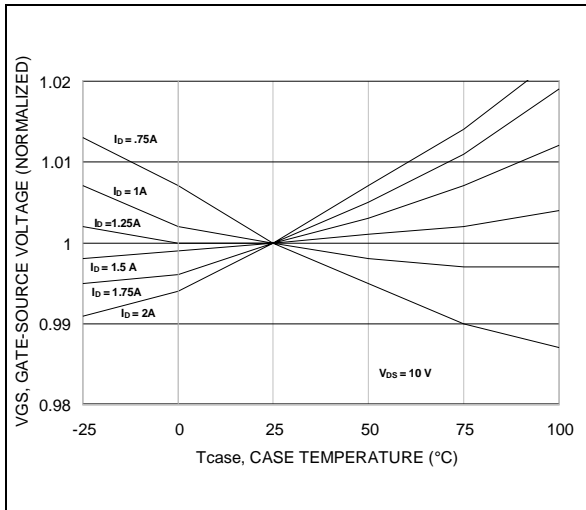

Safe Operating Area

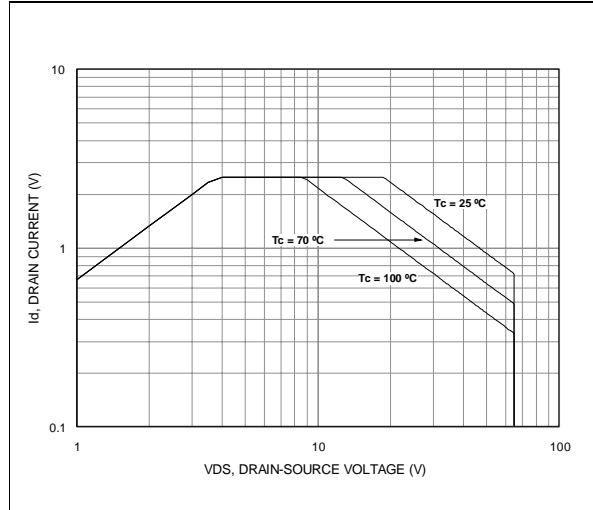

PD57018 - PD57018S

TYPICAL PERFORMANCE

Output Power vs. Input Power PD57018

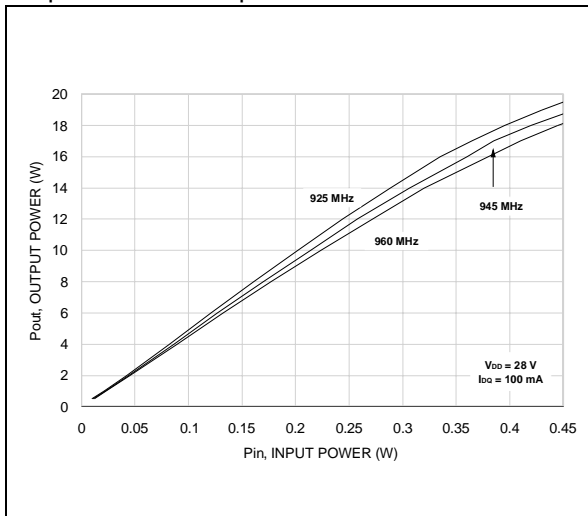

Power Gain vs. Output

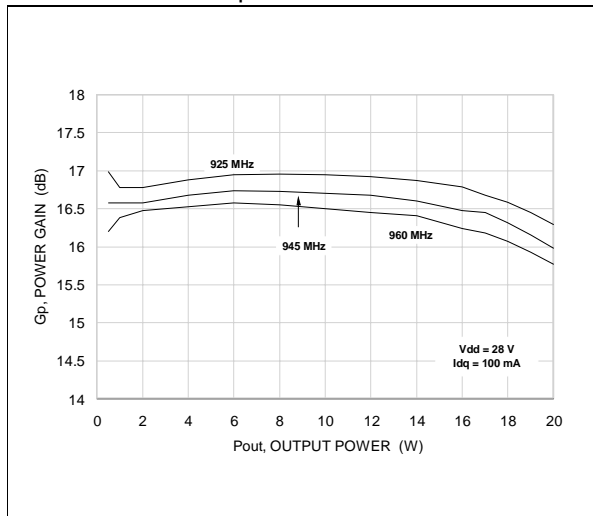

Drain Efficiency vs. Output Power

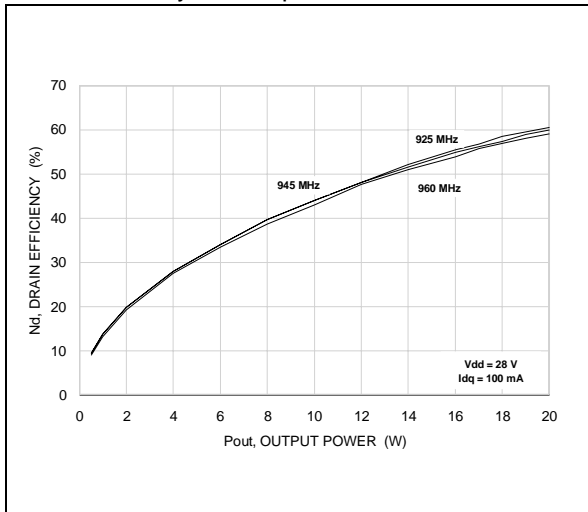

Return Loss vs. Output Power

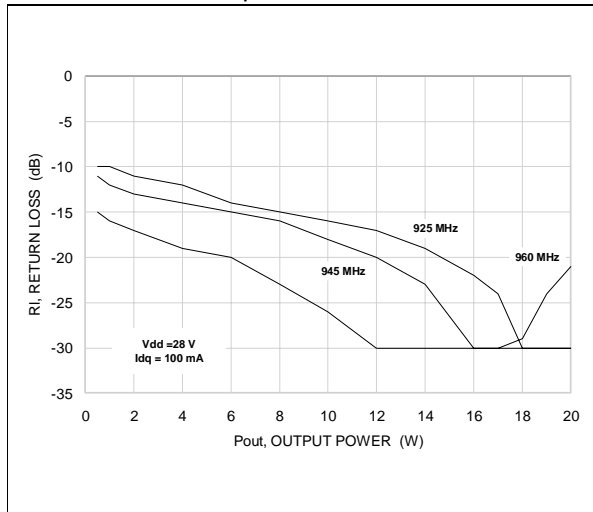

Output Power vs. Bias Current

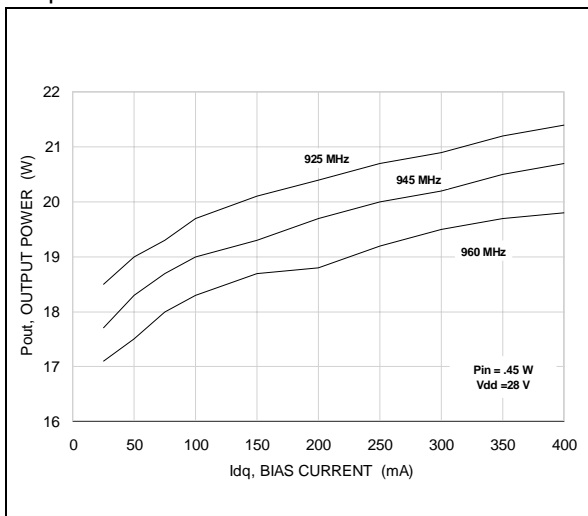

Efficiency vs. Bias Current

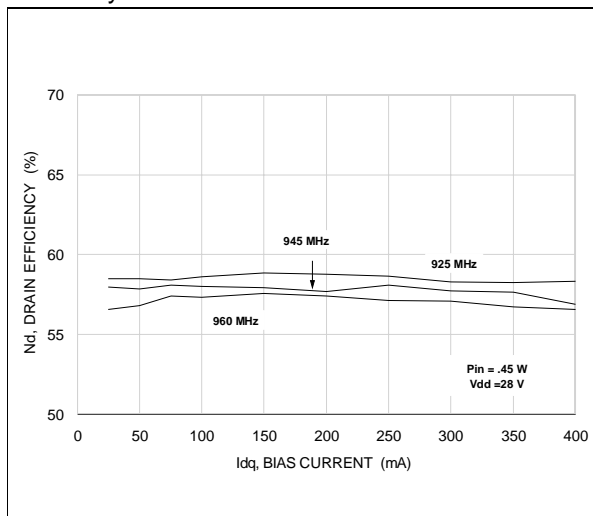

TYPICAL PERFORMANCE

Output Power vs. Drain Voltage

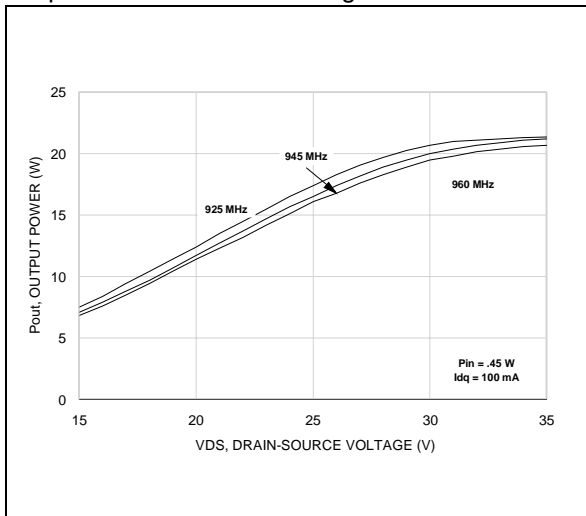

Output Power vs. Gate Voltage

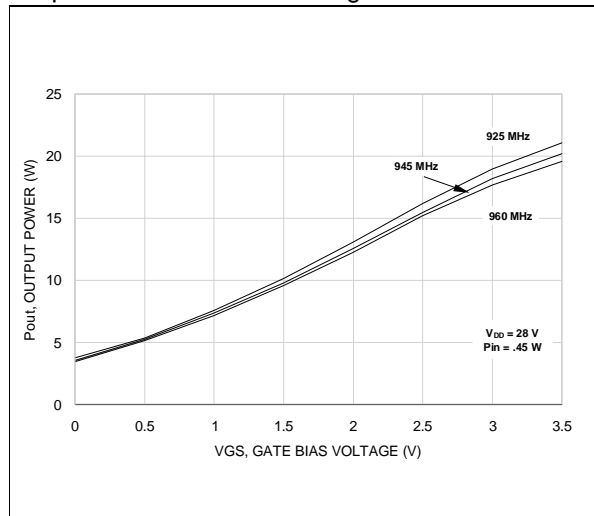

PD57018 - PD57018S

TYPICAL PERFORMANCE

Output Power vs. Input Power

PD57018S

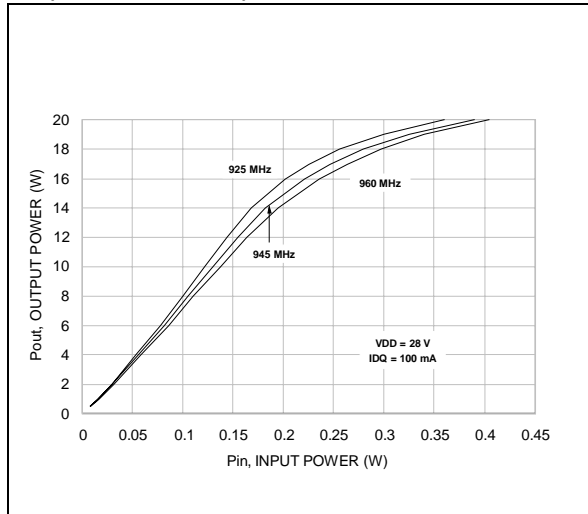

Power Gain vs. Output Power

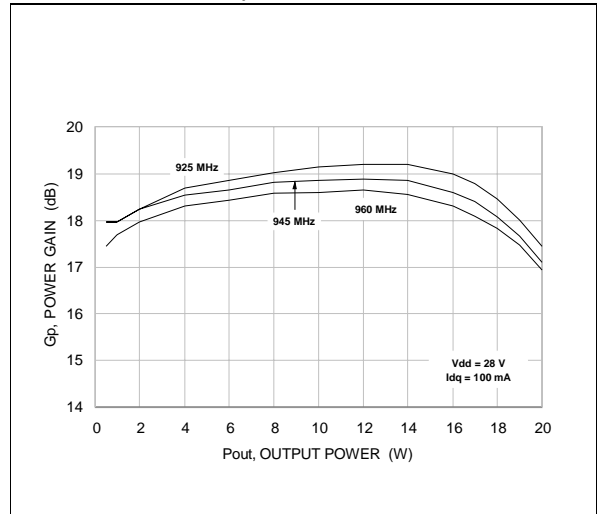

Drain Efficiency vs. Output Power

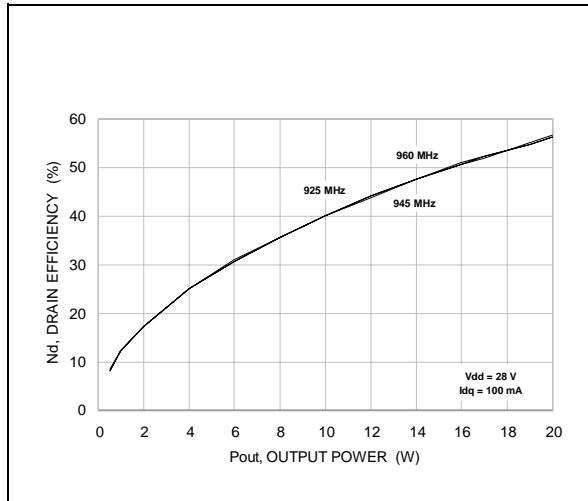

Return Loss vs. Output Power

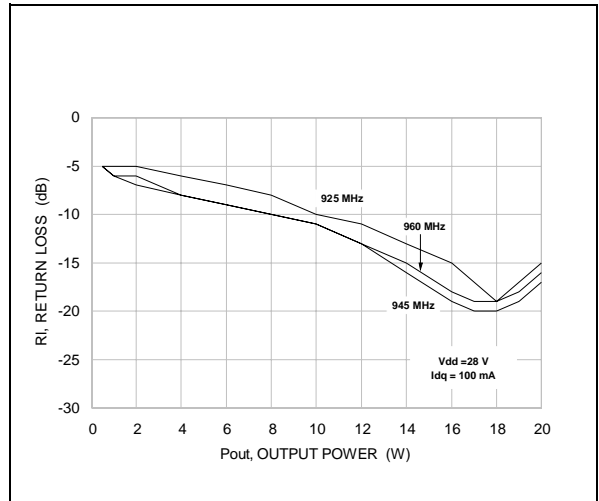

Output Power vs. Bias Current

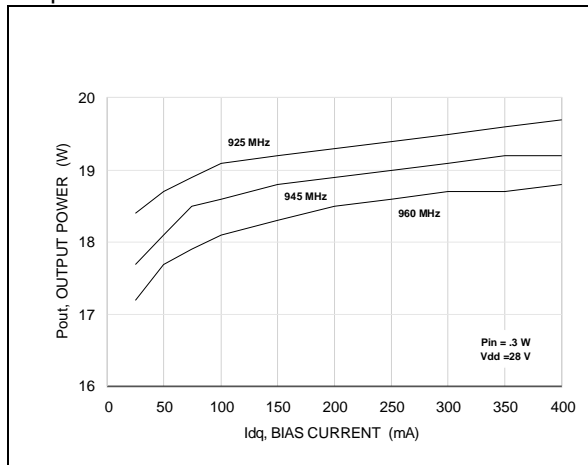

Efficiency vs. Bias Current

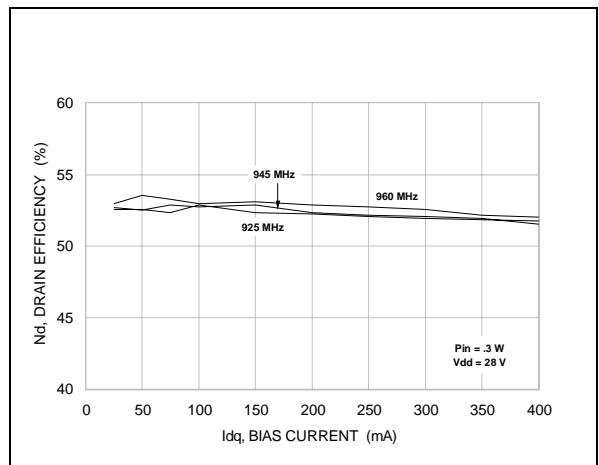

TYPICAL PERFORMANCE

Output Power vs. Drain Voltage

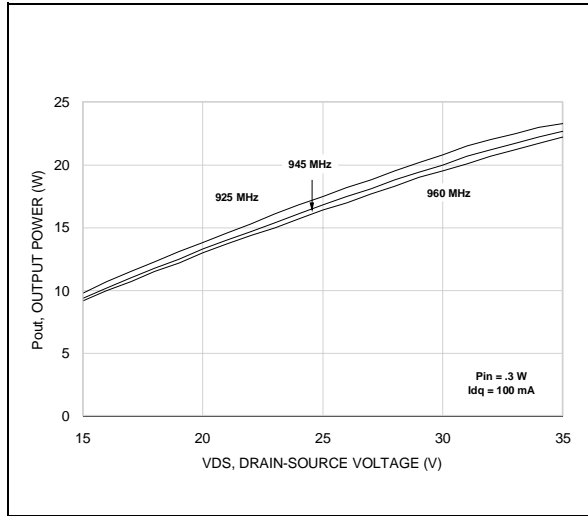

Output Power vs. Gate Voltage

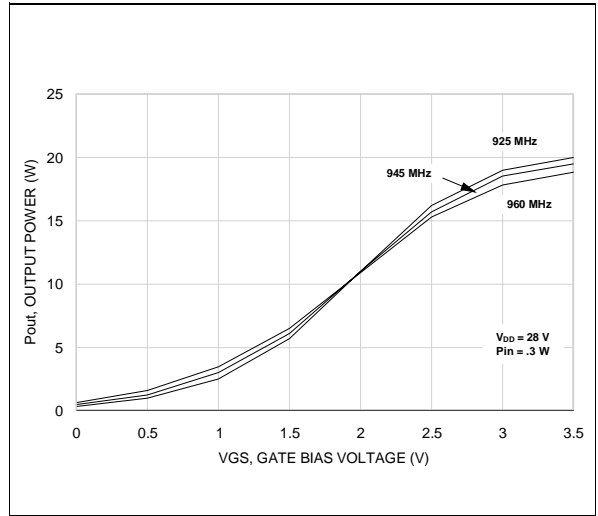

TEST CIRCUIT SCHEMATIC

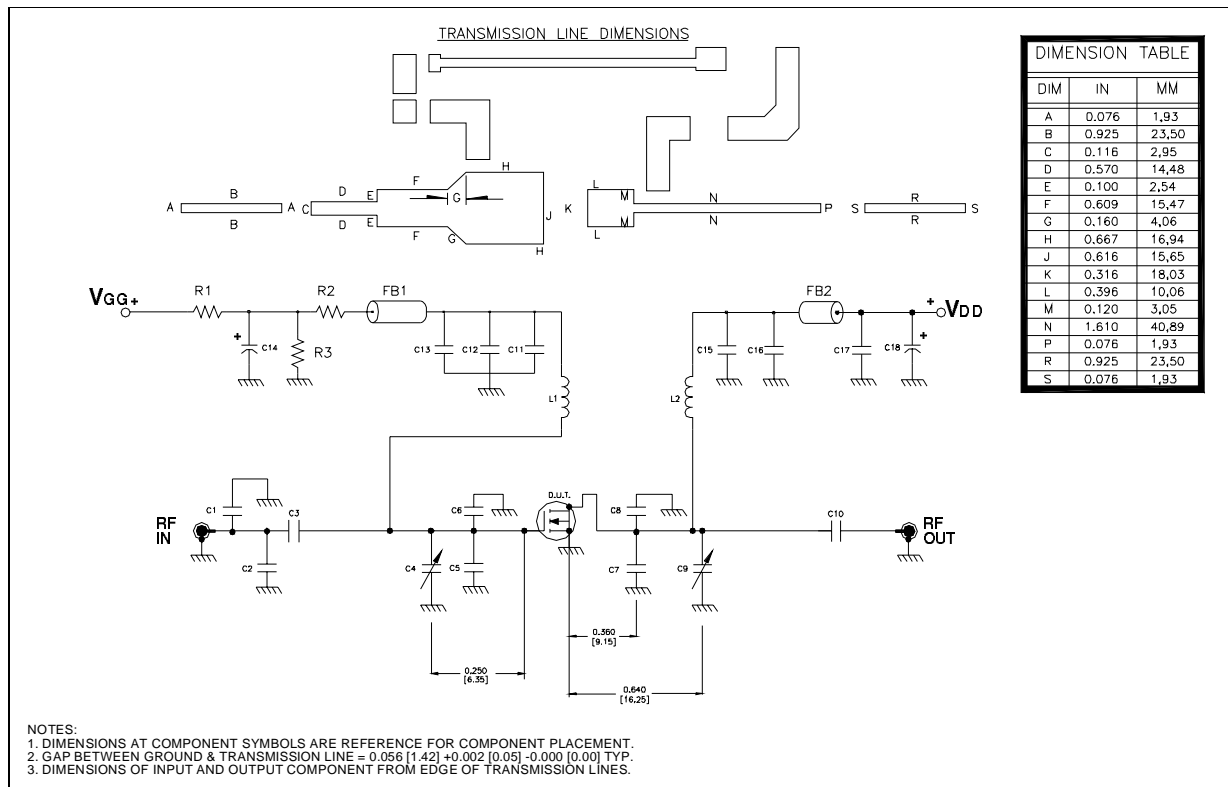

TEST CIRCUIT COMPONENT PART LIST

COMPONENT	DESCRIPTION
C1,C4, C9	0.8 - 8.0 pF GIGA TRIM VARIABLE CAPACITOR
C2	2.7 pF ATC 100B SURFACE MOUNT CERAMIC CHIP CAPACITOR
C3, C10, C11, C15	47 pF ATC 100B SURFACE MOUNT CERAMIC CHIP CAPACITOR
C5, C6, C7, C8	7.5 pF ATC 100B SURFACE MOUNT CERAMIC CHIP CAPACITOR
C12	1000 pF ATC 700B SURFACE MOUNT CERAMIC CHIP CAPACITOR
C13, C17	0.1 μF / 500 V SURFACE MOUNT CERAMIC CHIP CAPACITOR
C14	10 μF / 50 V ALUMINUM ELECTROLYTIC RADIAL LEAD CAPACITOR
C16	100 pF ATC 100B SURFACE MOUNT CERAMIC CHIP CAPACITOR
C18	220 μF / 63 V ALUMINUM ELECTROLYTIC RADIAL LEAD CAPACITOR
C19 ⁽¹⁾	4.3 pF ATC 100B SURFACE MOUNT CERAMIC CHIP CAPACITOR
C19 ⁽²⁾	2.7 pF ATC 100B SURFACE MOUNT CERAMIC CHIP CAPACITOR
R1	430 OHM, 1/8 W SURFACE MOUNT CHIP RESISTOR
R2	1 K OHM, 1/8 W SURFACE MOUNT CHIP RESISTOR
FB1, FB2,FB3	SHIELD BEAD SURFACE MOUNT EMI
L1, L2	INDUCTOR, 5 TURNS AIR WOUND #22AWG, ID=0.059[1.49], NYLON COATED MAGNET WIRE
BOARD	ROGER ULTRA LAM 2000 THK 0.030" ε _r = 2.55 2oz ED Cu BOTH SIDES

TEST CIRCUIT

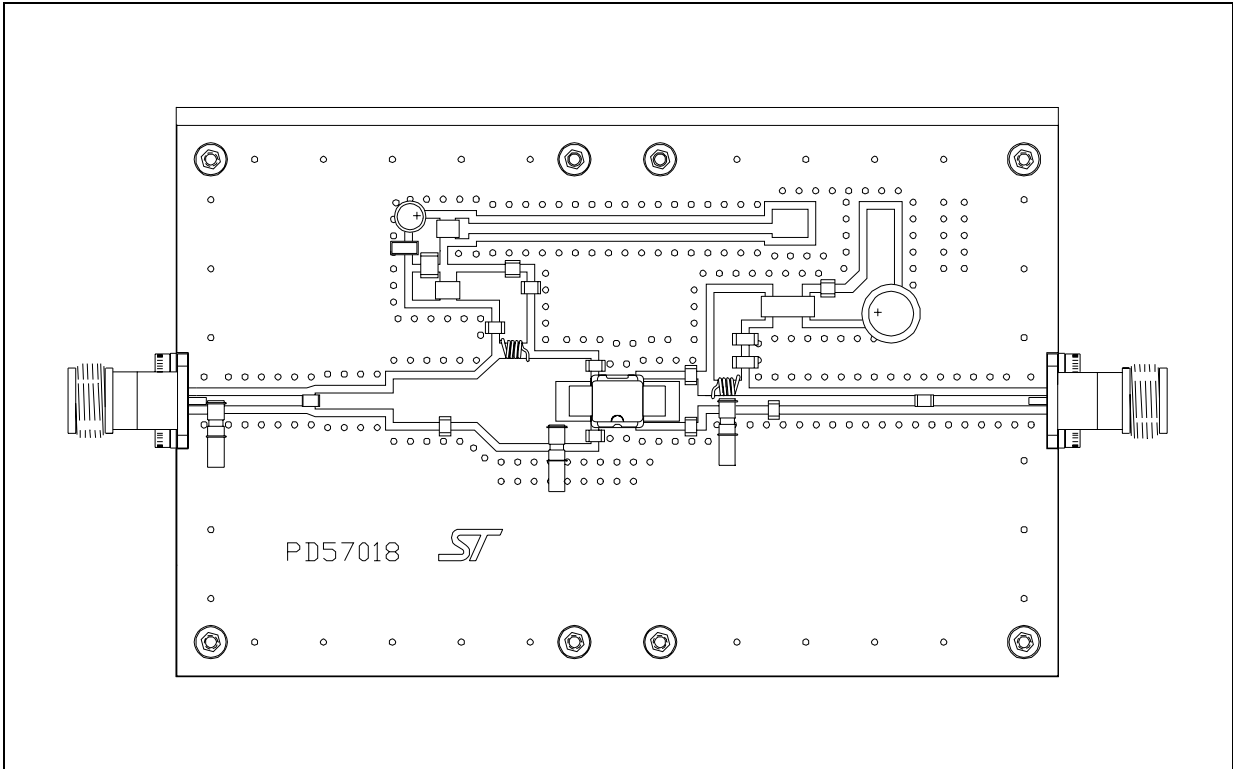

TEST CIRCUIT PHOTOMASTER

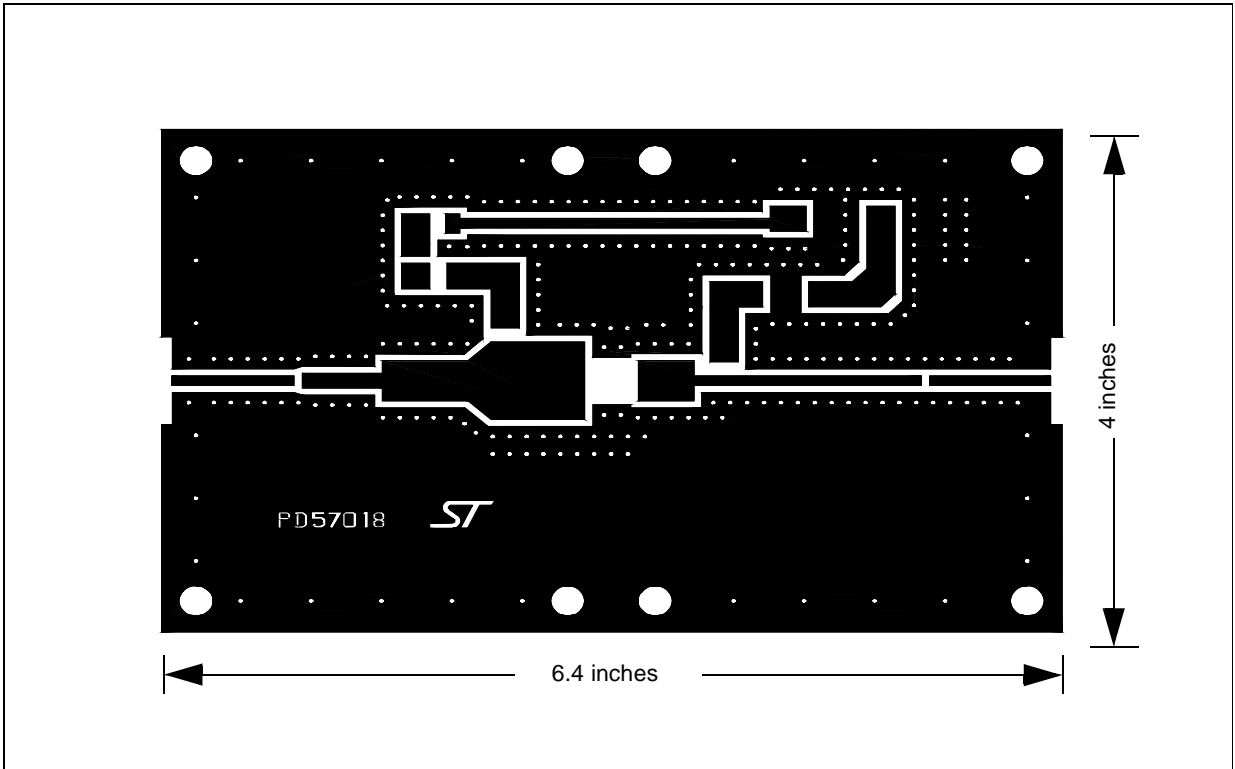

PD57018 - PD57018S

COMMON SOURCE S-PARAMETER (PD57018S)

($V_{DS} = 28V$ $I_{DS} = 0.4A$)

FREQ (MHz)	$ S_{11} $	$S_{11}\angle\Phi$	$ S_{21} $	$S_{21}\angle\Phi$	$ S_{12} $	$S_{12}\angle\Phi$	$ S_{22} $	$S_{22}\angle\Phi$
50	0.868	-109	36.63	115	0.020	26	0.551	-96
100	0.834	-140	19.69	93	0.022	5	0.523	-123
150	0.835	-151	13.11	81	0.022	-6	0.548	-133
200	0.845	-158	9.59	71	0.021	-15	0.589	-138
250	0.856	-162	7.41	63	0.020	-21	0.631	-142
300	0.868	-164	5.90	57	0.018	-26	0.672	-145
350	0.881	-167	4.82	51	0.017	-30	0.712	-148
400	0.892	-168	4.02	45	0.016	-35	0.744	-150
450	0.902	-170	3.40	40	0.014	-38	0.775	153
500	0.910	-172	2.90	36	0.013	-39	0.799	-155
550	0.917	-173	2.51	32	0.011	-40	0.822	-157
600	0.925	-174	2.20	28	0.010	-45	0.841	-159
650	0.930	-176	1.93	25	0.009	-44	0.857	-160
700	0.935	-177	1.72	21	0.008	-46	0.870	-162
750	0.938	-178	1.54	18	0.007	-43	0.883	-164
800	0.941	-179	1.38	15	0.006	-38	0.892	-165
850	0.944	-180	1.25	13	0.005	-35	0.901	-166
900	0.945	179	1.15	10	0.004	-40	0.906	-168
950	0.946	178	1.04	8	0.003	-25	0.915	-169
1000	0.949	177	0.96	6	0.003	-1	0.919	-170
1050	0.949	177	0.88	4	0.002	6	0.925	-171
1100	0.951	176	0.82	2	0.003	8	0.927	-172
1150	0.951	175	0.77	0	0.003	34	0.932	-173
1200	0.951	174	0.72	-2	0.004	52	0.937	-173
1250	0.949	174	0.67	-4	0.004	59	0.939	-174
1300	0.948	172	0.64	-6	0.004	56	0.942	-176
1350	0.950	172	0.60	-9	0.005	66	0.941	-176
1400	0.949	171	0.57	-11	0.007	71	0.942	-177
1450	0.948	170	0.53	-13	0.006	73	0.944	-178
1500	0.945	170	0.50	-15	0.006	93	0.942	-179

COMMON SOURCE S-PARAMETER (PD57018S)

(V_{DS} = 28V I_{DS} =0.8A)

FREQ (MHz)	S ₁₁	S ₁₁ ∠Φ	S ₂₁	S ₂₁ ∠Φ	S ₁₂	S ₁₂ ∠Φ	S ₂₂	S ₂₂ ∠Φ
50	0.872	-113	37.19	114	0.019	25	0.519	-103
100	0.843	-142	20.40	93	0.021	5	0.509	-129
150	0.843	-153	13.58	81	0.020	-6	0.537	-137
200	0.852	-159	9.96	72	0.019	-13	0.576	-141
250	0.862	-163	7.72	64	0.019	-18	0.618	-144
300	0.871	-166	6.17	58	0.017	-26	0.658	147
350	0.883	-168	5.06	52	0.015	-28	0.697	-149
400	0.893	-170	4.23	46	0.014	-30	0.729	-151
450	0.903	-171	3.59	41	0.013	-34	0.760	-154
500	0.910	-173	3.08	37	0.012	-35	0.785	-157
550	0.917	-174	2.66	33	0.011	-38	0.808	-157
600	0.923	-175	2.34	29	0.010	-41	0.828	-159
650	0.929	-176	2.06	25	0.008	-40	0.844	-161
700	0.932	-177	1.84	22	0.007	-41	0.858	-162
750	0.937	-179	1.64	19	0.006	-40	0.879	-169
800	0.939	-179	1.48	16	0.005	-32	0.882	-165
850	0.942	-180	1.34	14	0.005	-34	0.891	-166
900	0.942	179	1.22	11	0.003	-37	0.898	-168
950	0.944	178	1.12	9	0.003	-17	0.906	-169
1000	0.947	177	1.04	6	0.003	-5	0.910	-170
1050	0.947	176	0.95	4	0.003	24	0.918	-171
1100	0.949	175	0.89	2	0.003	32	0.920	-172
1150	0.949	175	0.82	0	0.003	49	0.924	-173
1200	0.949	174	0.77	-2	0.004	55	0.930	-173
1250	0.947	173	0.73	-4	0.005	62	0.933	-174
1300	0.947	172	0.68	-6	0.005	63	0.937	-176
1350	0.948	171	0.65	-9	0.005	74	0.935	-176
1400	0.949	171	0.61	-11	0.006	73	0.937	-177
1450	0.947	170	0.57	-13	0.006	74	0.938	-178
1500	0.944	169	0.54	-15	0.005	86	0.937	-179

PD57018 - PD57018S

COMMON SOURCE S-PARAMETER (PD57018S)

(V_{DS} = 28V I_{DS} =1.2A)

FREQ (MHz)	S ₁₁	∠S ₁₁ Φ	S ₂₁	∠S ₂₁ Φ	S ₁₂	∠S ₁₂ Φ	S ₂₂	∠S ₂₂ Φ
50	0.872	-113	37.35	113	0.018	25	0.511	-103
100	0.844	-143	20.42	92	0.020	5	0.503	-129
150	0.845	-154	13.60	81	0.020	-6	0.532	-137
200	0.854	-160	9.97	72	0.019	-13	0.571	-141
250	0.863	-163	7.71	64	0.017	-20	0.614	-144
300	0.873	-166	6.16	57	0.017	-26	0.655	-147
350	0.885	-168	5.05	51	0.015	-28	0.694	-149
400	0.895	-170	4.23	46	0.014	-31	0.727	-151
450	0.904	-171	3.58	41	0.012	-35	0.759	-153
500	0.912	-173	3.07	36	0.012	-35	0.783	-155
550	0.918	-174	2.66	32	0.011	-40	0.806	-157
600	0.924	-175	2.33	28	0.009	-40	0.827	-159
650	0.929	-177	2.05	25	0.008	-43	0.843	-161
700	0.933	-178	1.83	22	0.007	-39	0.857	-162
750	0.938	-179	1.64	19	0.006	-42	0.871	-164
800	0.940	-180	1.48	15	0.005	-35	0.882	-165
850	0.943	179	1.33	13	0.005	-27	0.891	-166
900	0.942	179	1.22	10	0.004	-38	0.898	-168
950	0.945	178	1.11	8	0.003	-11	0.906	-169
1000	0.948	177	1.02	5	0.002	10	0.911	-170
1050	0.948	176	0.95	3	0.003	24	0.918	-171
1100	0.950	175	0.89	1	0.004	31	0.920	-172
1150	0.949	174	0.82	-1	0.003	48	0.925	-173
1200	0.949	174	0.77	-3	0.004	63	0.929	-173
1250	0.947	173	0.72	-5	0.005	55	0.932	-174
1300	0.947	172	0.68	-7	0.005	65	0.936	-176
1350	0.948	171	0.64	-10	0.006	72	0.934	-176
1400	0.948	170	0.61	-12	0.006	71	0.937	-177
1450	0.947	170	0.57	-14	0.007	74	0.938	-178
1500	0.943	169	0.54	-16	0.007	88	0.937	-179



COMMON SOURCE S-PARAMETER (PD57018)

(V_{DS} = 28V I_{DS} = 0.4A)

FREQ (MHz)	S ₁₁	∠S ₁₁ Φ	S ₂₁	∠S ₂₁ Φ	S ₁₂	∠S ₁₂ Φ	S ₂₂	∠S ₂₂ Φ
50	0.866	-109	36.21	115	0.020	26	0.556	-93
100	0.834	-140	19.98	92	0.022	5	0.522	-121
150	0.834	-152	13.32	80	0.022	-7	0.546	-131
200	0.846	-158	9.75	70	0.020	-16	0.587	-137
250	0.856	-162	7.50	62	0.019	-21	0.630	-141
300	0.869	-165	5.97	55	0.018	-27	0.676	-145
350	0.880	-168	4.86	48	0.016	-31	0.715	-148
400	0.892	-170	4.05	42	0.015	-34	0.749	-150
450	0.903	-172	3.42	37	0.013	-37	0.778	-153
500	0.911	-174	2.91	33	0.012	-41	0.806	-156
550	0.922	-175	2.52	29	0.010	-42	0.826	-158
600	0.927	-177	2.19	25	0.009	-42	0.844	-160
650	0.933	-178	1.93	21	0.008	-39	0.859	-162
700	0.937	-180	1.72	17	0.006	-42	0.876	-164
750	0.940	179	1.54	14	0.005	-30	0.886	-166
800	0.946	178	1.39	12	0.006	-26	0.896	-168
850	0.950	177	1.25	9	0.004	-21	0.905	-169
900	0.949	176	1.13	6	0.002	-3	0.907	-171
950	0.949	175	1.03	3	0.002	28	0.918	-172
1000	0.951	174	0.95	1	0.003	46	0.920	-173
1050	0.949	173	0.87	-1	0.004	42	0.924	-174
1100	0.948	172	0.82	-3	0.005	62	0.929	-175
1150	0.948	171	0.76	-5	0.005	63	0.929	-177
1200	0.944	169	0.70	-8	0.005	68	0.938	-178
1250	0.947	168	0.67	-10	0.007	75	0.939	-179
1300	0.946	167	0.62	-12	0.008	72	0.941	180
1350	0.949	165	0.58	-14	0.009	72	0.939	179
1400	0.951	165	0.55	-17	0.010	73	0.939	178
1450	0.953	164	0.52	-18	0.010	74	0.941	177
1500	0.950	163	0.48	-20	0.010	83	0.938	176

PD57018 - PD57018S

COMMON SOURCE S-PARAMETER (PD57018)

($V_{DS} = 28V$ $I_{DS} = 0.8A$)

FREQ (MHz)	$ S_{11} $	$\angle S_{11}$	$ S_{21} $	$\angle S_{21}$	$ S_{12} $	$\angle S_{12}$	$ S_{22} $	$\angle S_{22}$
50	0.868	-112	39.29	111	0.019	24	0.523	-99
100	0.841	-142	20.99	89	0.020	5	0.507	-126
150	0.840	-154	13.61	79	0.020	-6	0.532	-135
200	0.852	-160	10.01	69	0.019	-13	0.573	-140
250	0.860	-164	7.78	62	0.018	-19	0.615	-143
300	0.871	-167	6.62	55	0.016	-25	0.660	-146
350	0.883	-169	5.14	50	0.014	-29	0.699	-149
400	0.892	-171	4.27	43	0.013	-32	0.734	-152
450	0.903	-173	3.64	38	0.012	-36	0.762	-154
500	0.911	-174	3.10	33	0.011	-37	0.791	-156
550	0.921	176	2.69	29	0.009	-36	0.814	-159
600	0.927	-177	2.33	25	0.008	-35	0.832	-161
650	0.931	-179	2.07	22	0.007	-32	0.847	-163
700	0.936	180	1.85	18	0.006	-34	0.864	-165
750	0.939	179	1.66	15	0.004	-26	0.876	-166
800	0.944	177	1.50	12	0.004	-19	0.886	-168
850	0.948	176	1.35	9	0.004	-4	0.896	-169
900	0.947	175	1.23	7	0.003	13	0.899	-171
950	0.946	174	1.13	4	0.004	41	0.909	-172
1000	0.948	173	1.03	1	0.004	37	0.913	-173
1050	0.947	173	0.95	-1	0.005	52	0.919	-174
1100	0.946	171	0.89	-4	0.005	60	0.922	-175
1150	0.945	170	0.83	-5	0.006	63	0.923	-177
1200	0.941	169	0.77	-9	0.007	66	0.933	-178
1250	0.946	168	0.72	-11	0.008	74	0.931	-178
1300	0.945	167	0.67	-13	0.009	71	0.937	180
1350	0.947	166	0.63	-15	0.009	71	0.934	179
1400	0.949	164	0.58	-18	0.010	70	0.934	178
1450	0.950	163	0.55	-20	0.001	73	0.938	177
1500	0.948	162	0.51	-21	0.001	83	0.933	176

COMMON SOURCE S-PARAMETER (PD57018)

(V_{DS} = 28V I_{DS} = 1.2A)

FREQ (MHz)	S ₁₁	∠S ₁₁	S ₂₁	∠S ₂₁	S ₁₂	∠S ₁₂	S ₂₂	∠S ₂₂
50	0.870	-113	38.10	113	0.018	25	0.516	-100
100	0.843	-143	20.76	92	0.019	5	0.500	-126
150	0.843	-154	13.83	79	0.019	-6	0.527	-135
200	0.854	-160	10.14	70	0.018	-13	0.570	-139
250	0.863	-164	7.81	62	0.017	-20	0.612	-143
300	0.874	-167	6.24	55	0.016	-24	0.658	-146
350	0.883	-169	5.09	49	0.014	-28	0.698	-149
400	0.894	-171	4.27	43	0.013	-32	0.733	-151
450	0.904	-173	3.60	38	0.011	-35	0.762	-154
500	0.912	-175	3.08	33	0.010	-35	0.791	-156
550	0.922	-176	2.66	29	0.009	-36	0.812	-159
600	0.928	-178	2.33	25	0.008	-37	0.831	-161
650	0.932	-179	2.05	21	0.007	-37	0.847	-162
700	0.936	180	1.83	18	0.005	-34	0.864	-164
750	0.940	178	1.63	14	0.004	-25	0.875	-166
800	0.945	177	1.48	12	0.004	-11	0.885	-168
850	0.948	176	1.33	9	0.003	-5	0.896	-169
900	0.947	175	1.21	6	0.003	17	0.899	-171
950	0.946	174	1.10	3	0.004	43	0.910	-172
1000	0.950	173	1.02	1	0.004	47	0.913	-173
1050	0.948	172	0.93	-2	0.005	55	0.918	-174
1100	0.946	171	0.88	-4	0.006	59	0.922	-175
1150	0.946	170	0.81	-6	0.006	66	0.922	-177
1200	0.942	169	0.75	-8	0.007	66	0.932	-178
1250	0.945	168	0.71	-11	0.008	70	0.933	-178
1300	0.945	167	0.67	-13	0.008	68	0.937	-180
1350	0.947	166	0.62	-15	0.009	72	0.934	179
1400	0.949	164	0.59	-18	0.010	72	0.935	178
1450	0.950	163	0.55	-19	0.011	73	0.937	177
1500	0.948	162	0.51	-22	0.011	83	0.933	176

PowerSO-10RF Formed Lead (Gull Wing) MECHANICAL DATA

DIM.	mm			Inch		
	MIN.	TYP.	MAX	MIN.	TYP.	MAX
A1	0	0.05	0.1	0.	0.0019	0.0038
A2	3.4	3.5	3.6	0.134	0.137	0.142
A3	1.2	1.3	1.4	0.046	0.05	0.054
A4	0.15	0.2	0.25	0.005	0.007	0.009
a		0.2			0.007	
b	5.4	5.53	5.65	0.212	0.217	0.221
c	0.23	0.27	0.32	0.008	0.01	0.012
D	9.4	9.5	9.6	0.370	0.374	0.377
D1	7.4	7.5	7.6	0.290	0.295	0.298
E	13.85	14.1	14.35	0.544	0.555	0.565
E1	9.3	9.4	9.5	0.365	0.37	0.375
E2	7.3	7.4	7.5	0.286	0.292	0.294
E3	5.9	6.1	6.3	0.231	0.24	0.247
F		0.5			0.019	
G		1.2			0.047	
L	0.8	1	1.1	0.030	0.039	0.042
R1			0.25			0.01
R2		0.8			0.031	
T	2 deg	5 deg	8 deg	2 deg	5 deg	8 deg
T1		6 deg			6 deg	
T2		10 deg			10 deg	

Note (1): Resin protrusions not included (max value: 0.15 mm per side)

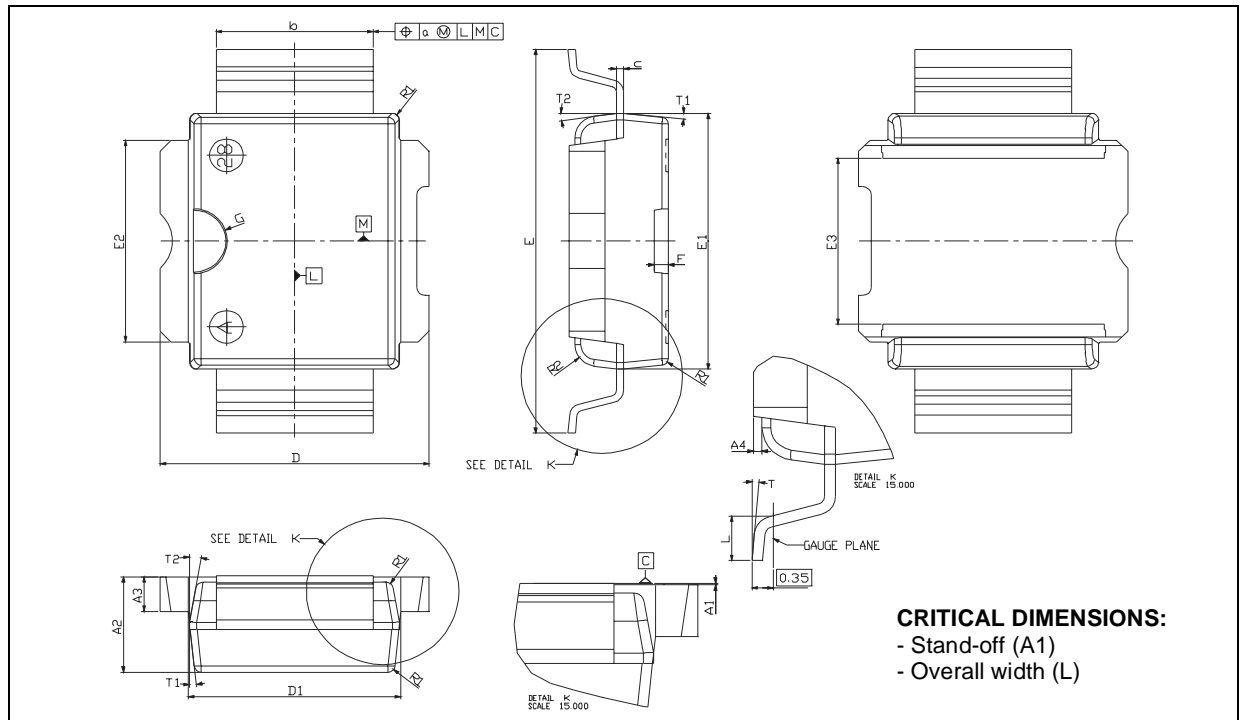

PowerSO-10RF Straight Lead MECHANICAL DATA

DIM.	mm			Inch		
	MIN.	TYP.	MAX	MIN.	TYP.	MAX
A1	1.62	1.67	1.72	0.064	0.065	0.068
A2	3.4	3.5	3.6	0.134	0.137	0.142
A3	1.2	1.3	1.4	0.046	0.05	0.054
A4	0.15	0.2	0.25	0.005	0.007	0.009
a		0.2			0.007	
b	5.4	5.53	5.65	0.212	0.217	0.221
c	0.23	0.27	0.32	0.008	0.01	0.012
D	9.4	9.5	9.6	0.370	0.374	0.377
D1	7.4	7.5	7.6	0.290	0.295	0.298
E	15.15	15.4	15.65	0.595	0.606	0.615
E1	9.3	9.4	9.5	0.365	0.37	0.375
E2	7.3	7.4	7.5	0.286	0.292	0.294
E3	5.9	6.1	6.3	0.231	0.24	0.247
F		0.5			0.019	
G		1.2			0.047	
R1			0.25			0.01
R2		0.8			0.031	
T1		6 deg			6 deg	
T2		10 deg			10 deg	

Note (1): Resin protrusions not included (max value: 0.15 mm per side)

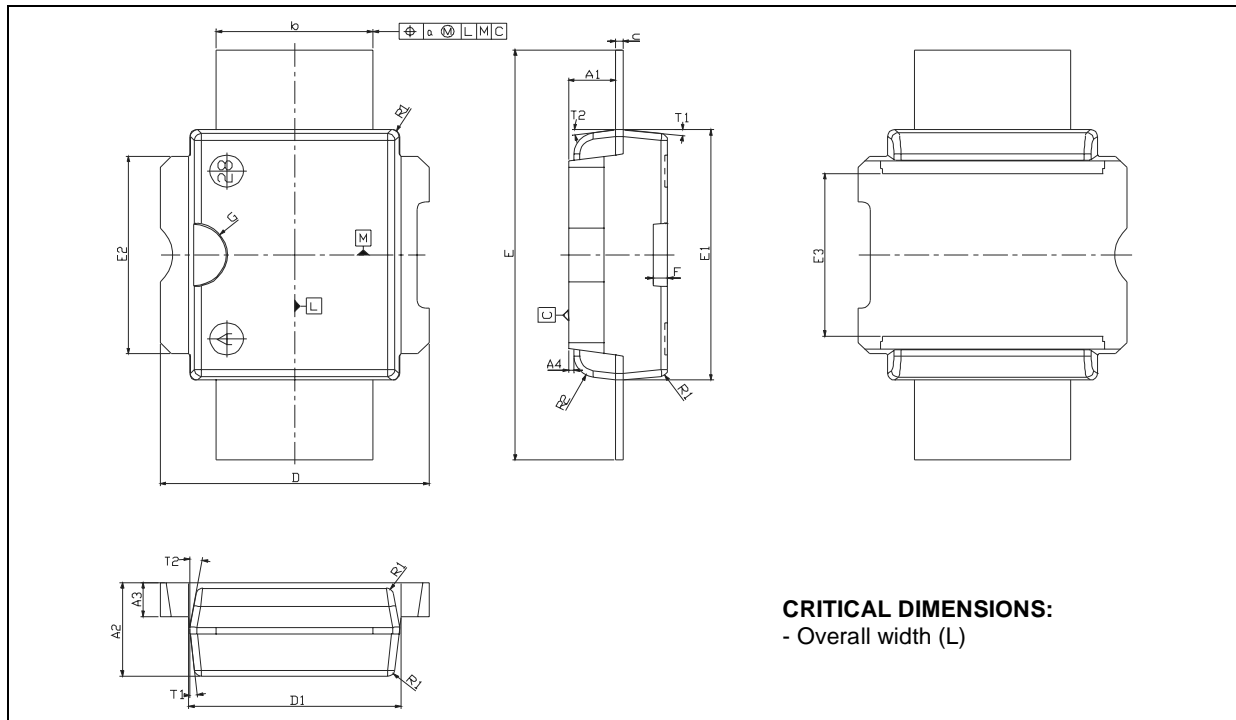

Information furnished is believed to be accurate and reliable. However, STMicroelectronics assumes no responsibility for the consequences of use of such information nor for any infringement of patents or other rights of third parties which may result from its use. No license is granted by implication or otherwise under any patent or patent rights of STMicroelectronics. Specifications mentioned in this publication are subject to change without notice. This publication supersedes and replaces all information previously supplied. STMicroelectronics products are not authorized for use as critical components in life support devices or systems without express written approval of STMicroelectronics.

The ST logo is registered trademark of STMicroelectronics
2003 STMicroelectronics - All Rights Reserved

All other names are the property of their respective owners.

STMicroelectronics GROUP OF COMPANIES
Australia - Brazil - China - Finland - France - Germany - Hong Kong - India - Italy - Japan - Malaysia - Malta - Morocco -
Singapore - Spain - Sweden - Switzerland - United Kingdom - U.S.A.

<http://www.st.com>