

## ADJUSTABLE HIGH PRECISION SHUNT REGULATOR

### ■GENERAL DESCRIPTION

The **NJM1431A** is a precision shunt regulator. Compared to the conventional 431, The **NJM1431A** offers higher voltage accuracy and small package availability to support a wide range of applications.

### ■PACKAGE OUTLINE



**NJM1431AL1**

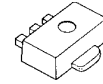

**NJM1431AU**



**NJM1431AF**

### ■FEATURES

- Operating Voltage  $V_{REF}$  to 36V
- Precision Voltage Reference  $2.465V \pm 1\%$
- 2.9mm × 1.5mm to MTP (SOT23) package
- Adjustable Output Voltage For  
External Resistance two Parts.
- Bipolar Technology
- Package Outline TO-92, SOT-89 (3pin), MTP5

### ■BLOCK DIAGRAM

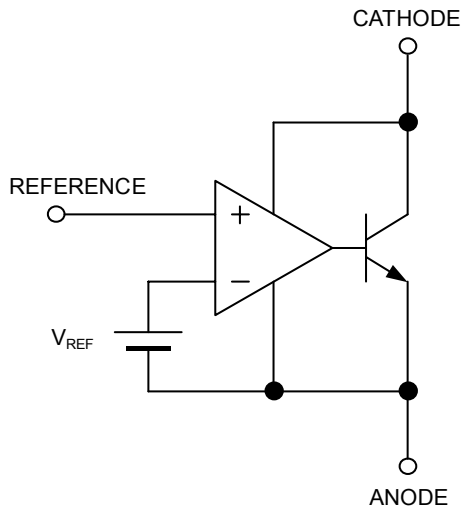

### ■PIN CONFIGURATION

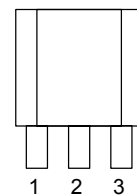

**NJM1431AL1**

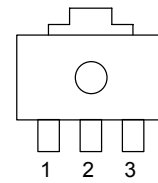

**NJM1431AU**

1. REFERENCE
2. ANODE
3. CATHODE

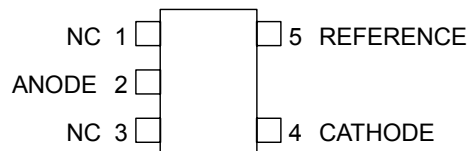

**NJM1431AF**

# NJM1431A

## ■ABSOLUTE MAXIMUM RATINGS (Ta=25°C)

PARAMETER	SYMBOL	MAXIMUM RATINGS	UNIT
Cathode Voltage	$V_{KA}$	+37	V
Continuous Cathode Current	$I_K$	-100 ~ 150	mA
Reference Input Current	$I_{REF}$	-0.05 ~ 10	mA
Power Dissipation	$P_D$	(TO-92) 500 (SOT-89) 350 (MTP5) 200	mW
Operating Temperature Range	$T_{OPR}$	-40 ~ +85	°C
Storage Temperature Range	$T_{STG}$	-40 ~ +150	°C

## ■RECOMMENDED OPERATING CONDITIONS (Ta=25°C)

PARAMETER	SYMBOL	MIN.	TYP.	MAX.	UNIT
Cathode Voltage	$V_{KA}$	$V_{REF}$	—	36	V
Cathode Current	$I_K$	1	—	100	mA

## ■ELECTRICAL CHARACTERISTICS ( $I_K=10mA$ , Ta=25°C)

PARAMETER	SYMBOL	TEST CONDITION	MIN.	TYP.	MAX.	UNIT
Reference Voltage	$V_{REF}$	$V_{KA}=V_{REF}$ (*1)	2.440	2.465	2.490	V
Reference Voltage Change vs. Cathode Voltage Change	$\Delta V_{REF}/\Delta V_{KA}$	$ V_{REF}  \leq V_{KA} \leq 10V$ (*2)	—	$\pm 1.4$	$\pm 2.7$	mV/V
		$10V \leq V_{KA} \leq 36V$ (*2)	—	$\pm 1.0$	$\pm 2.0$	mV/V
Reference Input Current	$I_{REF}$	$R1=10k\Omega$ , $R2=\infty$ (*2)	—	2	4	$\mu A$
Minimum Input Current	$I_{MIN}$	$V_{KA}=V_{REF}$ , $\Delta V_{REF}=1\%$ (*1)	—	0.4	1.0	mA
Cathode Current (Off Cond.)	$I_{OFF}$	$V_{KA}=36V$ , $V_{REF}=0V$ (*3)	—	0.1	1.0	$\mu A$
Dynamic Impedance	$ Z_{KA} $	$V_{KA}=V_{REF}$ , $f \leq 1kHz$ $1mA \leq I_K \leq 100mA$ (*1)	—	0.2	0.5	$\Omega$

## ■TEMPERATURE CHARACTERISTICS ( $I_K=10mA$ , Ta= -40°C ~ 85°C)

PARAMETER	SYMBOL	TEST CONDITION	MIN.	TYP.	MAX.	UNIT
Reference Voltage Change	$\Delta V_{REF}$	$V_{KA}=V_{REF}$ (*1)	—	8	17	mV
Reference Input Current Change	$\Delta I_{REF}$	$R1=10k\Omega$ , $R2=\infty$ (*2)	—	0.4	1.2	$\mu A$

The maximum value of “Dynamic Impedance”, “Reference Voltage Change” and “Reference Input Current Change” are determined based on sampling evaluation from the 5 initial production lots, and thus not tested in the production test.

Therefore, these values are for the reference design purpose only.

$|V_{REF}|$ ...Reference voltage includes error.

(\*1): Test Circuit (Fig.1)

(\*2): Test Circuit (Fig.2)

(\*3): Test Circuit (Fig.3)

## ■TEST CIRCUIT

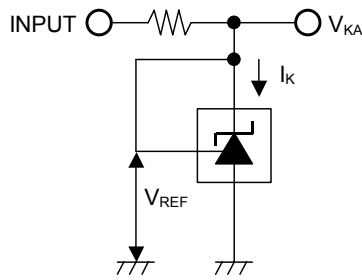

Fig.1  $V_{KA}=V_{REF}$  to test circuit

$$V_O = V_{KA} = V_{REF}$$

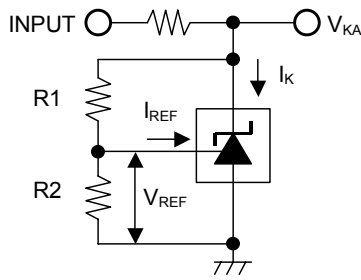

Fig.2  $V_{KA} > V_{REF}$  to test circuit

$$V_O = V_{KA} = V_{REF} \left( 1 + \frac{R1}{R2} \right) + I_{REF} \times R1$$

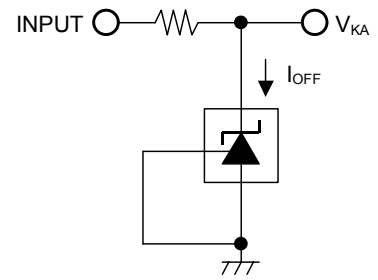
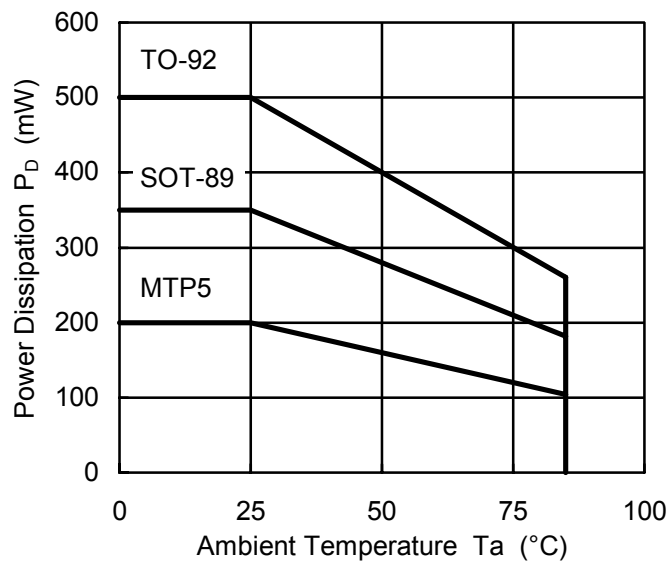

Fig.3  $I_{OFF}$  to test circuit

## ■POWER DISSIPATION VS. AMBIENT TEMPERATURE



## ■ TYPICAL CHARACTERISTICS

Reference Voltage vs. Cathode Current

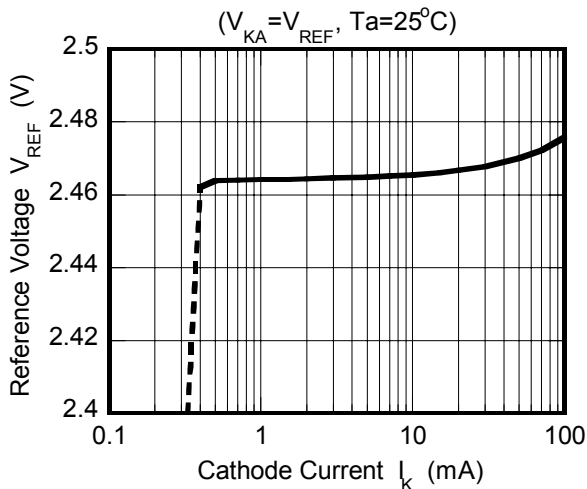

Reference Voltage vs. Temperature

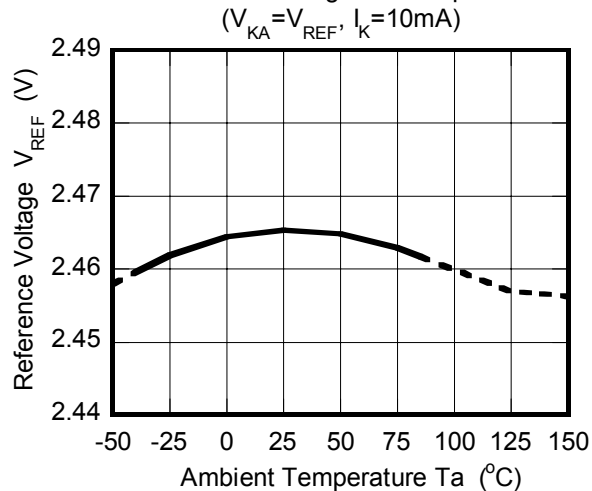

Reference Input Current vs. Temperature

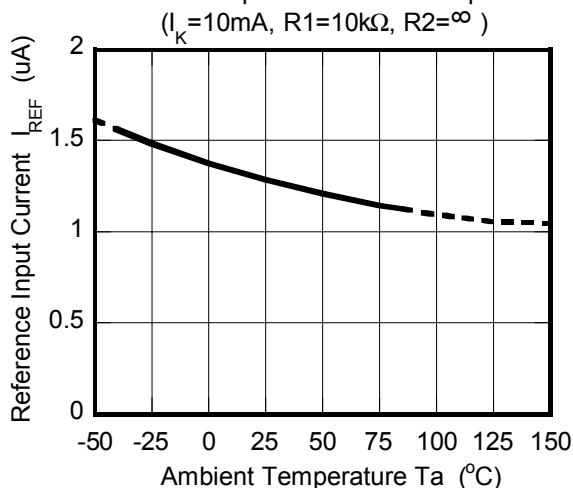

Reference Voltage vs. Cathode Voltage

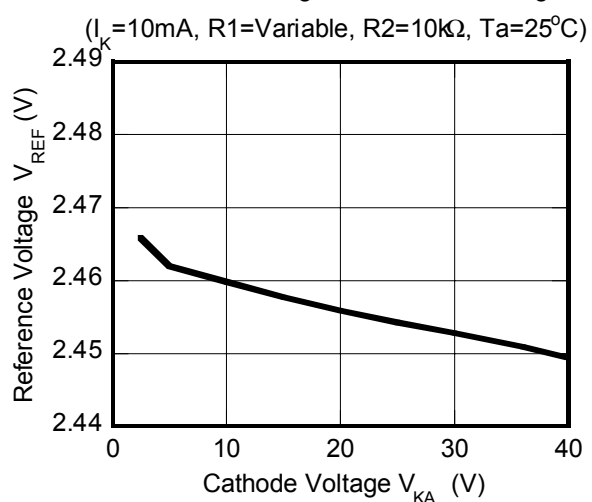

Safety Operating Boundary Condition

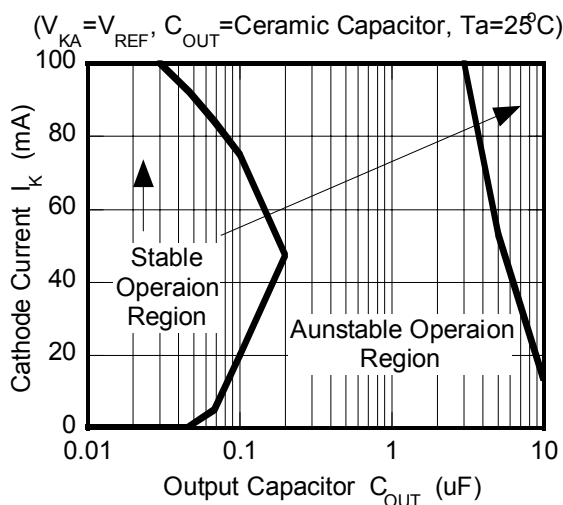

Dynamic Impedance

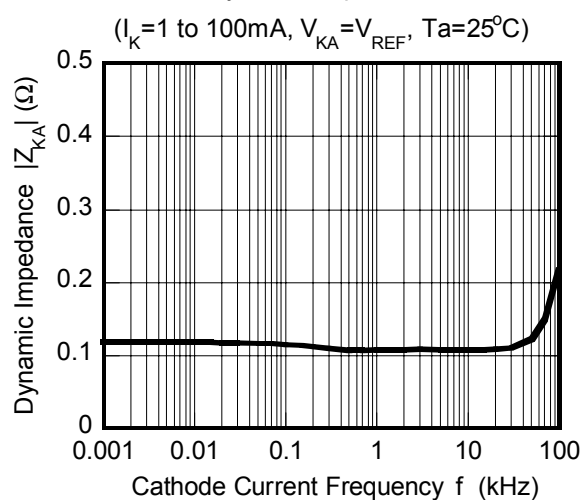

Note) Oscillation might occur while operating within the range of safety curve.

So that, it is necessary to make ample margins by taking considerations of fluctuation of the device.

MEMO

[CAUTION]

The specifications on this databook are only given for information, without any guarantee as regards either mistakes or omissions. The application circuits in this databook are described only to show representative usages of the product and not intended for the guarantee or permission of any right including the industrial rights.