

# MAXIM

## MAX2150 Evaluation Kit

**Evaluates: MAX2150**

### General Description

The MAX2150 evaluation kit (EV kit) simplifies testing of the MAX2150 complete wideband I/Q modulator chip. The kit allows evaluation of the I/Q modulator, synthesizer, 3-wire programming interface, and power-management features. The EV kit provides 50Ω connectors for all signal inputs and outputs.

### Features

- ◆ 3-Wire Control Interface
- ◆ Differential Baseband Inputs
- ◆ 2.7V to 3.6V Single-Supply Operation
- ◆ 50Ω Connectors on All Signal Ports
- ◆ Low-Power Shutdown Modes
- ◆ PC Control Software  
(Available at [www.maxim-ic.com](http://www.maxim-ic.com))

### Ordering Information

PART	TEMP RANGE	IC PACKAGE
MAX2150EVKIT	-40°C to +85°C	28 QFN

### Component Suppliers

SUPPLIERS	PHONE	FAX	WEBSITE
AVX	843-448-9411	843-448-7139	<a href="http://www.avxcorp.com">www.avxcorp.com</a>
Coilcraft	800-322-2645	847-639-1469	<a href="http://www.coilcraft.com">www.coilcraft.com</a>
Murata	770-436-1300	770-436-3030	<a href="http://www.murata.com">www.murata.com</a>
Taiyo Yuden	800-368-2496	408-573-4159	<a href="http://www.t-yuden.com">www.t-yuden.com</a>
Toko	847-297-0070	847-699-7864	<a href="http://www.tokoam.com">www.tokoam.com</a>

### Component List

DESIGNATION	QTY	DESCRIPTION
BUFEN	1	3-pin header, 100mil centers Digi-Key S1012-36-ND
C1, C2, C3, C12, C18, C28, C30, C31, C34, C36, C37, C50, C52	13	0.1μF ±10% capacitors (0603) Murata GRM188R71C104K
C4, C9, C10, C11, C13, C35	6	100pF ±5% capacitors (0402) Murata GRP1555C1H101J
C5, C6, C7, C15, C16	5	Open
C8	1	22pF ±5% capacitor (0402) Murata GRP1555C1H220J
C14, C17	2	100pF ±5% capacitors (0603) Murata GRM1885C1H101J
C19, C20, C21, C32, C33	5	0.1μF ±10% capacitors (0402) Murata GRP155R61A104K
C22	1	6800pF ±10% capacitor (0402) Murata GRP155R71E682K
C23	1	0.068μF ±10% capacitor (0402) Murata GRP155R61A683K
C24	1	680pF ±10% capacitor (0402) Murata GRP155R71H681K

DESIGNATION	QTY	DESCRIPTION
C25	1	1μF ±10% tantalum capacitor, case A AVX TAJA105K016
C26	1	470pF ±10% capacitor (0402) Murata GRP155R71H471K
C27	1	1.0μF ±10% capacitor (0603) Murata GRM188R60J105K
DCIN, EN	2	Test points Digi-Key 5000-ND
J1, J3	2	50Ω BNC connectors, 31 series, Amphenol Allied Electronics 31-5329-52RFX 713-9041
J5, J6, J7, J11, J16, J17, J19, J20, VCCSD	9	2-pin headers, 100mil centers Digi-Key S1012-36-ND
J8, J13, J14, J15, J18 (Note 2)	5	SMA connectors, edge mount EFJohnson 142-0701-801
J10	1	10-pin header Digi-Key S2012-36-ND
J19, J20, BUFEN, VCCSD	4	Shunt-shorting jumpers Digi-Key S9000-ND



# MAX2150 Evaluation Kit

## Component List (continued)

DESIGNATION	QTY	DESCRIPTION
L1	1	Open
R1–R4, R29, R35	6	Open
R12	1	0 $\Omega$ $\pm$ 5% resistor (0402)
R13, R18	2	0 $\Omega$ $\pm$ 5% resistors (0603)
R23	1	245 $\Omega$ $\pm$ 5% resistor (0402)
R24, R25	2	1.1k $\Omega$ $\pm$ 1% resistors (0402)
R31–R34	4	3.3k $\Omega$ $\pm$ 5% resistors (0603)
U1 (Note 1)	1	MAX2150EGI I/Q wideband modulator
U2	1	VCO Fujitsu VC-3R0A23-0967/1750B
VTUNE_OUT	1	SMA connectors, PC mount EFJohnson 142-0701-201
Y1	1	20MHz surface-mount crystal CTS Reeves Digi-Key ATS200SM CTX515TR-ND
None	1	MAX2150 EV kit circuit board, rev C
None	1	MAX2150 data sheet
None	1	MAX2150 EV kit data sheet

**Note 1:** This IC has an exposed pad. It must be solder attached to the circuit board to ensure proper function.

**Note 2:** Cut center pin to approximately 1/16in long.

## Quick Start

The MAX2150 EV kit is fully assembled and factory tested. Follow the instructions in the *Connections and Setup* section.

### Test Equipment Required

This section lists the recommended test equipment to verify the operation of the MAX2150. It is intended as a guide only, and substitutions are possible.

- One RF signal generator capable of delivering -7dBm of output power in the 10MHz to 50MHz frequency range (HP 8648A or equivalent) for the PLL reference frequency
- RF spectrum analyzer capable of measuring up to 7GHz RF signal (Rohde & Schwarz FSEA20 or equivalent)
- RF power meter capable of measuring up to +10dBm output power (HP 437B or equivalent) with an RF sensor
- RF network analyzer
- Oscilloscope
- Two power supplies that can provide 250mA at +5.0V (AG E3631A or equivalent)
- Arbitrary waveform generator (HP E4433B or equivalent)

### Connections and Setup

This section provides step-by-step instructions for getting the EV kit up and running in all operation modes.

- 1) Verify that jumpers are in place.
- 2) Verify that the interface board is in place.

## Connector Description

CONNECTOR	NAME	DESCRIPTION	DC VOLTAGE RANGE
J1, J3	I, Q	I/Q Baseband Input BNC Connectors	—
J5, J19	VCCVCO	V <sub>CC</sub> to On-Board VCO	2.7V ~ 3.6V
J6	VCC	Supply Voltage	2.7V ~ 3.6V
J7, J11	GND	Ground	—
J8	RFOUT	RF Output (SMA)	—
J10	—	Interface Connection	2.7V ~ 3.6V
J13	BUFOUT	Buffer Output (SMA)	—
J14, J15	LO	External LO Input (SMA)	—
J16, J17	N.C.	No Connection	—
J18	REFL IN	Reference Input (SMA)	—
J20	LOCK	Lock Signal Output	—
—	BUFEN	Buffer Enable	—
—	DCIN	Bias Voltage Input	1.6V
—	EN	Enable Pin Input	—
—	TUNE_OUT	Tuning Voltage Output	—
—	VCCSD	V <sub>CC</sub> to Sigma-Delta Modulator	2.7V ~ 3.6V

# MAX2150 Evaluation Kit

- 3) Set the power supply to +3V and turn it off.
- 4) Set the adjustable power supply to +1.6V and turn it off.
- 5) Connect the ground terminal to GND.
- 6) Connect the positive +3V terminal to VCC and the power supply of the interface board.
- 7) Connect the positive terminal of the adjustable power supply to pin DCIN on the board.
- 8) Set the I/Q generator to 330kHz, with an input level of 1V<sub>p-p</sub>. Leave the I/Q generator output off.
- 9) Using 2 BNC cables, connect the output of the I/Q generator to the I/Q input connectors on the MAX2150 EV kit board.
- 10) Use an SMA cable to connect the RFOUT to the input of the spectrum analyzer.
- 11) Set the spectrum analyzer to view the output.
- 12) Turn on all power supplies and enable I/Q signal generator.
- 13) Measure the supply current level.
- 14) Observe the RF output frequency as displayed on the spectrum analyzer. Measure the RF output power.
- 15) The RF output power should be approximately -4dBm after accounting for cable and connector loss.

## **Adjustments and Control**

### **Operation Modes:**

- 1) TX mode
- 2) SYNTH mode
- 3) MOD mode
- 4) Software shutdown mode
- 5) Hardware shutdown mode

Refer to the MAX2150 data sheet for details.

### **Layout Issues**

A good PC board is an essential part of an RF circuit design. The EV kit PC board can serve as a guide for laying out a board using the MAX2150. Keep traces carrying RF signals as short as possible to minimize radiation and insertion loss. Use impedance control on all RF signal traces. The VCC node on the PC board should have decoupling capacitors to the closest ground. Refer to the *Layout* section of the MAX2150 data sheet for more information.

**Evaluates: MAX2150**

# MAX2150 Evaluation Kit

Evaluates: MAX2150

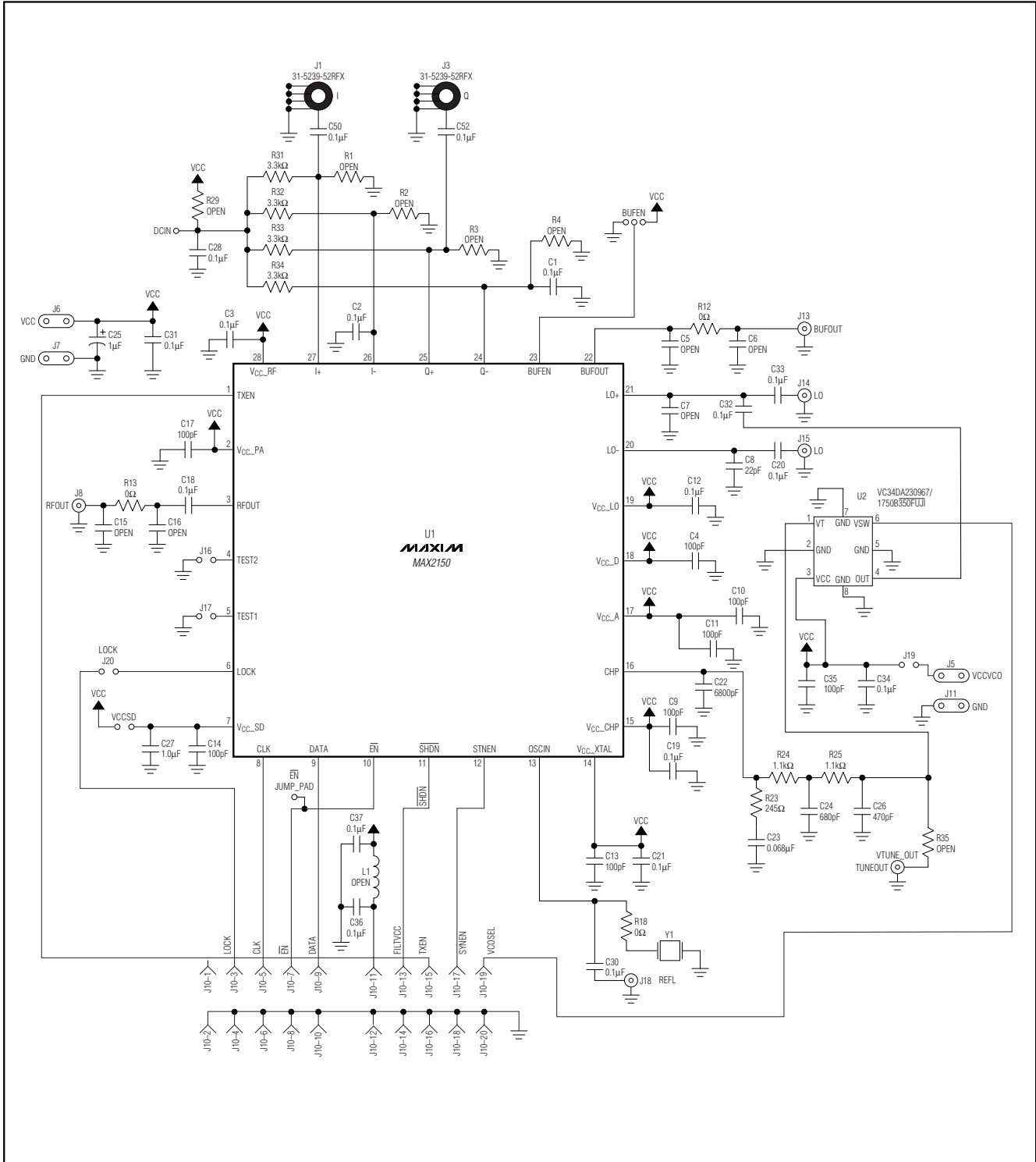
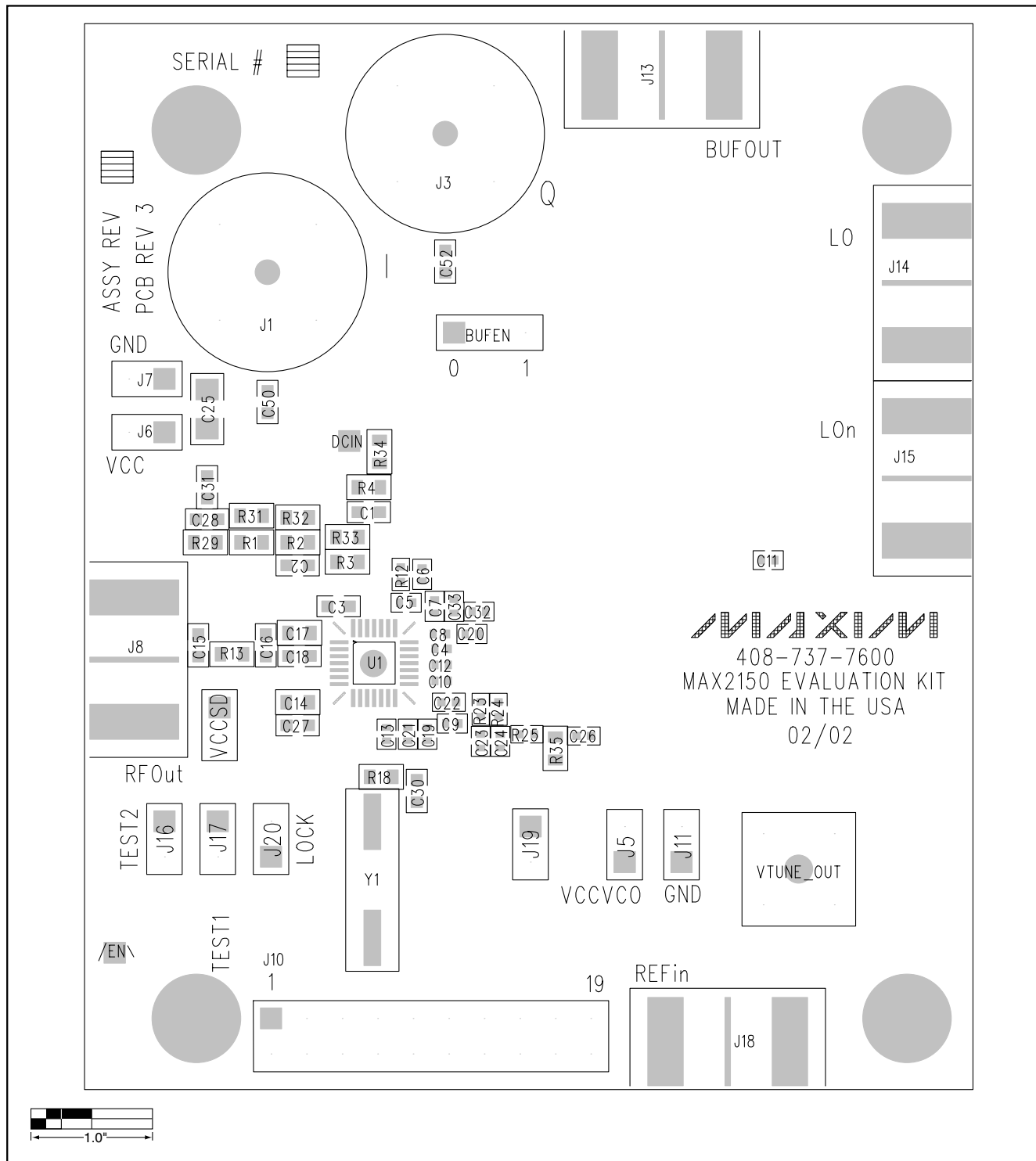

Figure 1. MAX2150 EV Kit Schematic

# MAX2150 Evaluation Kit

Evaluates: MAX2150



# MAX2150 Evaluation Kit

Evaluates: MAX2150

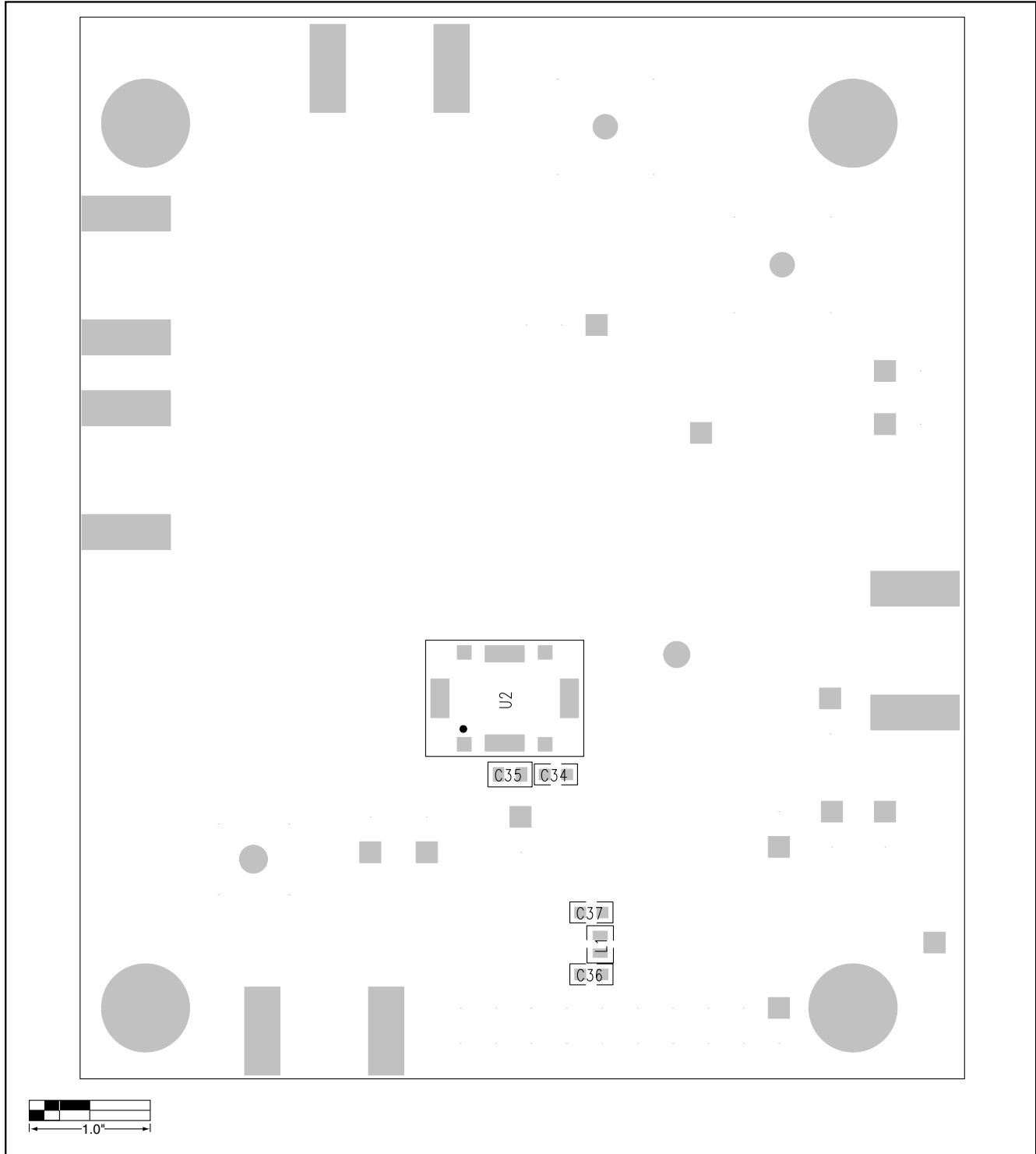

Figure 3. MAX2150 EV Kit Secondary-Side Silkscreen

# MAX2150 Evaluation Kit

Evaluates: MAX2150

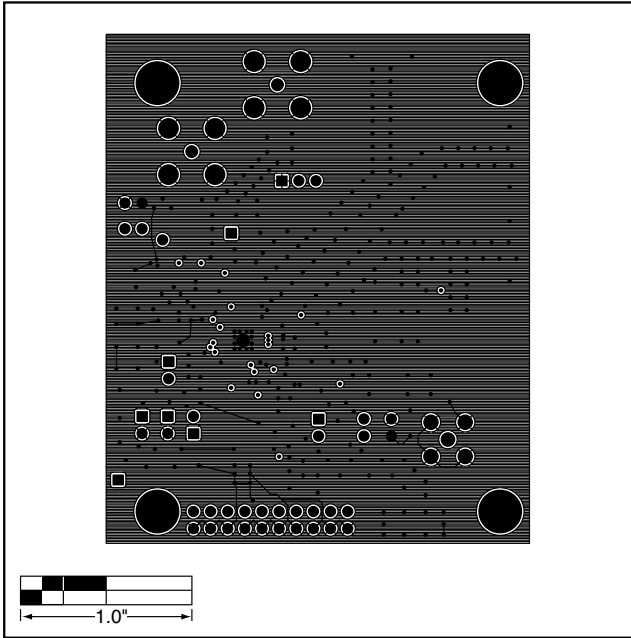

Figure 4. MAX2150 EV Kit PC Board Layout—Layer 2

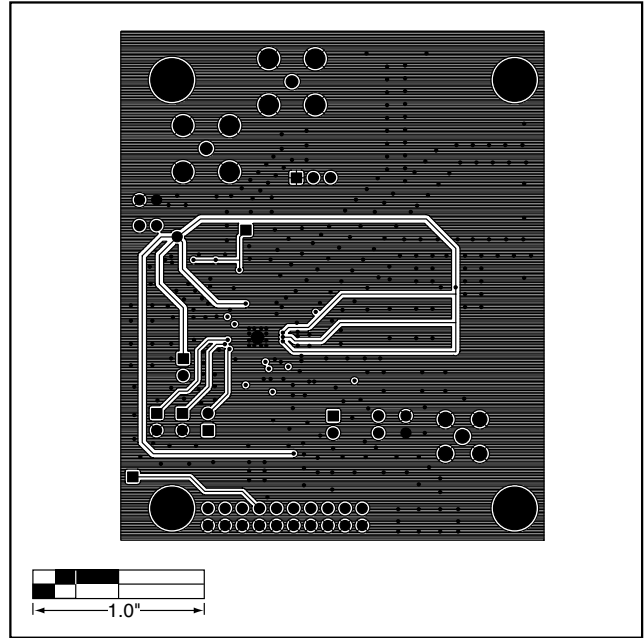

Figure 5. MAX2150 EV Kit PC Board Layout—Layer 3

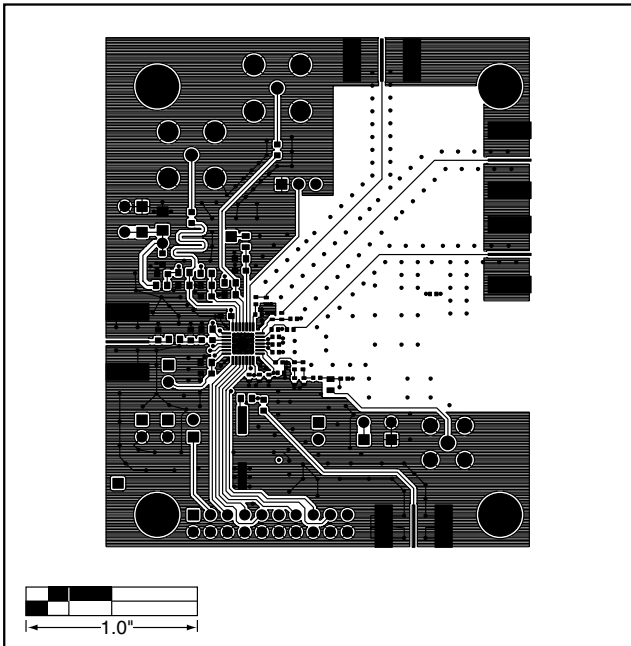

Figure 6. MAX2150 EV Kit Primary Component Side

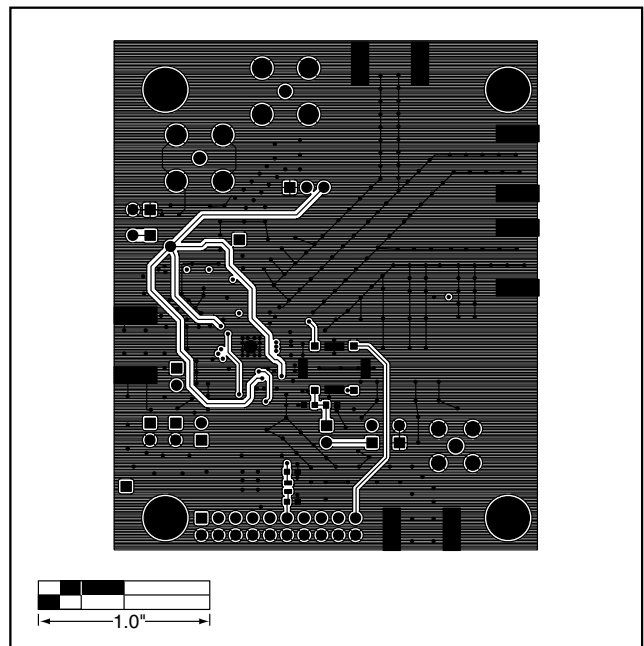

Figure 7. MAX2150 EV Kit Secondary Side

Maxim cannot assume responsibility for use of any circuitry other than circuitry entirely embodied in a Maxim product. No circuit patent licenses are implied. Maxim reserves the right to change the circuitry and specifications without notice at any time.

**Maxim Integrated Products, 120 San Gabriel Drive, Sunnyvale, CA 94086 408-737-7600** \_\_\_\_\_ **7**