



SAW Components

Data Sheet G 3355 K





SAW Components

G 3355 K

IF Filter for Quasi/Split Sound Applications

38,90 MHz

Data Sheet

Standard

- B/G

Plastic package **DIP10K**

Features

- TV IF filter for quasi/split sound applications (separate picture and sound channel)
- Picture channel with Nyquist slope and sound suppression
- Group delay predistortion
- Sound channel with passband only for sound carriers at 33,40 MHz and 33,05 MHz (NICAM)
- Suitable for CENELEC EN 55020

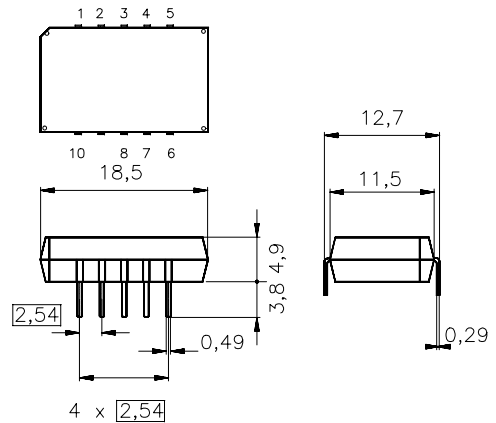

Dimensions in mm, approx. weight 1,8 g

Terminals

- Tinned CuFe alloy

Pin configuration

- 1 Input
- 2 Input - ground
- 3; 8 Chip carrier - ground
- 4; 5 Output - sound
- 6; 7 Output - picture
- 9 Free
- 10 Not connected

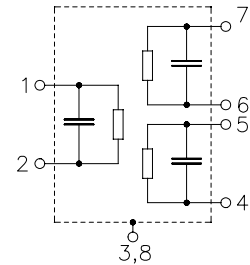

Type	Ordering code	Marking and package according to	Packing according to
G 3355 K	B39389-G3355-K100	C61157-A2-A3	F61074-V8068-Z000

Maximum ratings

Operable temperature range	T_A	-25/+65	°C	
Storage temperature range	T_{stg}	-40/+85	°C	
DC voltage	V_{DC}	12	V	between any terminals
AC voltage	V_{pp}	10	V	between any terminals



SAW Components

G 3355 K

IF Filter for Quasi/Split Sound Applications

38,90 MHz

Data Sheet

Characteristics of picture channel

Reference temperature: $T_A = 25\text{ °C}$
 Terminating source impedance: $Z_S = 50\ \Omega$
 Terminating load impedance: $Z_L = 2\text{ k}\Omega \parallel 3\text{ pF}$

		min.	typ.	max.	
Insertion attenuation					
	α				
Reference level for the following data	37,40 MHz	12,5	14,0	15,5	dB
Relative attenuation					
	α_{rel}				
Picture carrier	38,90 MHz	5,0	6,0	7,0	dB
Color carrier	34,47 MHz	-0,6	0,4	1,4	dB
Sound carrier	33,40 MHz	30,0	48,0	—	dB
Adjacent picture carrier	30,90 MHz	46,0	60,0	—	dB
	31,90 MHz	48,0	56,0	—	dB
	32,40 MHz	46,0	55,0	—	dB
	40,15 MHz	38,0	48,0	—	dB
Adjacent sound carrier	40,40 MHz	46,0	60,0	—	dB
	41,40 MHz	45,0	59,0	—	dB
Lower sidelobe	25,00 ... 31,90 MHz	40,0	46,0	—	dB
Upper sidelobe	40,40 ... 45,00 MHz	40,0	46,0	—	dB
Reflected wave signal suppression					
1,2 μ s ... 6,0 μ s after main pulse (test pulse 250 ns, carrier frequency 37,40 MHz)		42,0	52,0	—	dB
Feedthrough signal suppression					
1,2 μ s ... 1,1 μ s before main pulse (test pulse 250 ns, carrier frequency 37,40 MHz)		—	56,0	—	dB
Group delay predistortion					
(reference frequency 38,90 MHz)					
	$\Delta\tau$				
	36,30 MHz	—	-55	—	ns
	34,47 MHz	—	40	—	ns
Impedance at 37,40 MHz					
	Input: $Z_{IN} = R_{IN} \parallel C_{IN}$	—	1,0 \parallel 24,4	—	k Ω \parallel pF
	Output: $Z_{OUT} = R_{OUT} \parallel C_{OUT}$	—	1,6 \parallel 3,9	—	k Ω \parallel pF
Temperature coefficient of frequency					
	TC_f	—	-72	—	ppm/K



SAW Components

G 3355 K

IF Filter for Quasi/Split Sound Applications

38,90 MHz

Data Sheet

Characteristics of sound channel

Reference temperature: $T_A = 25\text{ °C}$
 Terminating source impedance: $Z_S = 50\ \Omega$
 Terminating load impedance: $Z_L = 2\text{ k}\Omega \parallel 3\text{ pF}$

		min.	typ.	max.	
Insertion attenuation					
	α				
Reference level for the following data	33,05 MHz	12,7	14,2	15,7	dB
Relative attenuation					
	α_{rel}				
Sound carrier	33,40 MHz	1,0	2,0	3,0	dB
Picture carrier	38,90 MHz	42,0	56,0	—	dB
Color carrier	34,47 MHz	28,0	35,0	—	dB
Adjacent picture carrier	30,90 MHz	30,0	37,0	—	dB
	31,90 MHz	32,0	41,0	—	dB
Adjacent sound carrier	40,40 MHz	42,0	53,0	—	dB
	41,40 MHz	42,0	54,0	—	dB
Lower sidelobe	25,00 ... 31,90 MHz	28,0	34,0	—	dB
Upper sidelobe	38,90 ... 45,00 MHz	38,0	46,0	—	dB
Impedance at 33,05 MHz					
	Output: $Z_{OUT} = R_{OUT} \parallel C_{OUT}$	—	4,1 \parallel 2,6	—	k Ω \parallel pF
Temperature coefficient of frequency					
	TC_f	—	-72	—	ppm/K



SAW Components

G 3355 K

IF Filter for Quasi/Split Sound Applications

38,90 MHz

Data Sheet

Frequency response of picture channel

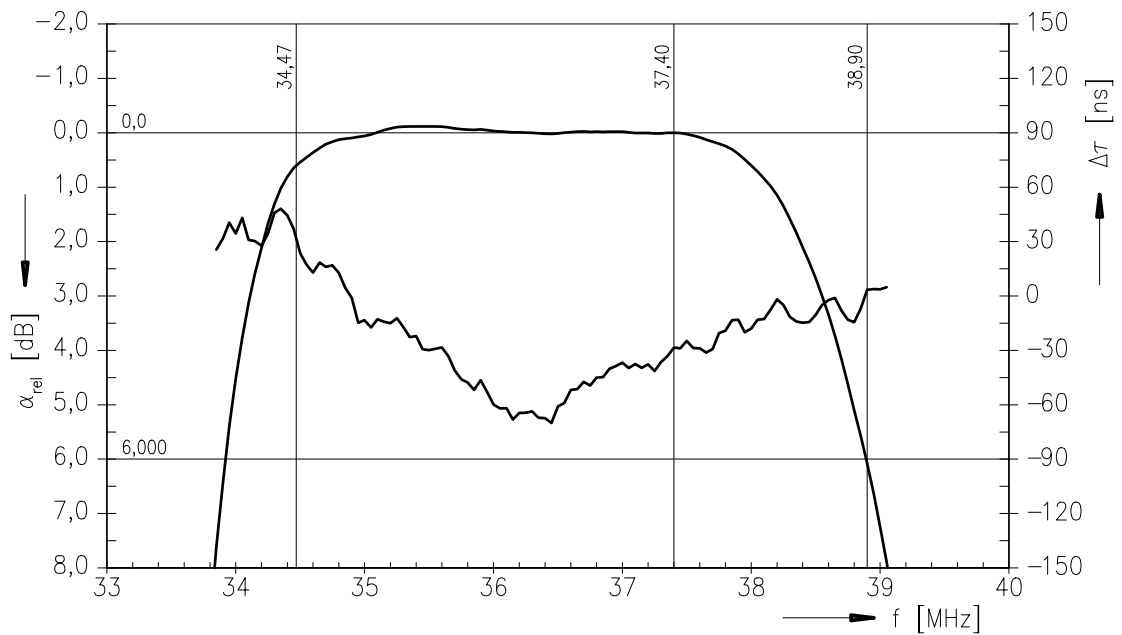
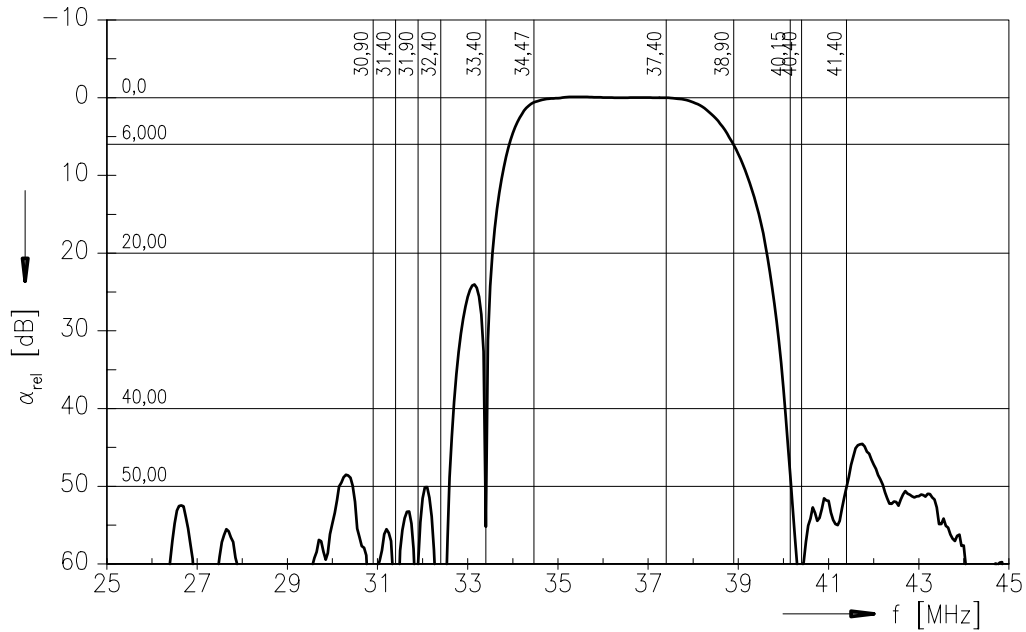



SAW Components

G 3355 K

IF Filter for Quasi/Split Sound Applications

38,90 MHz

Data Sheet

Frequency response of picture channel

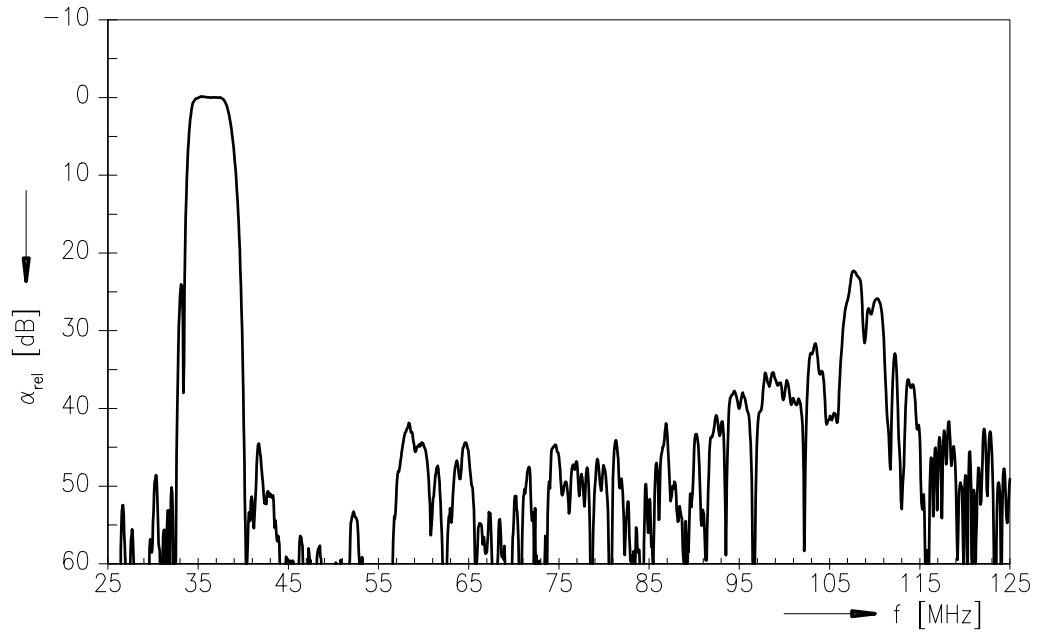

Time domain response of picture channel

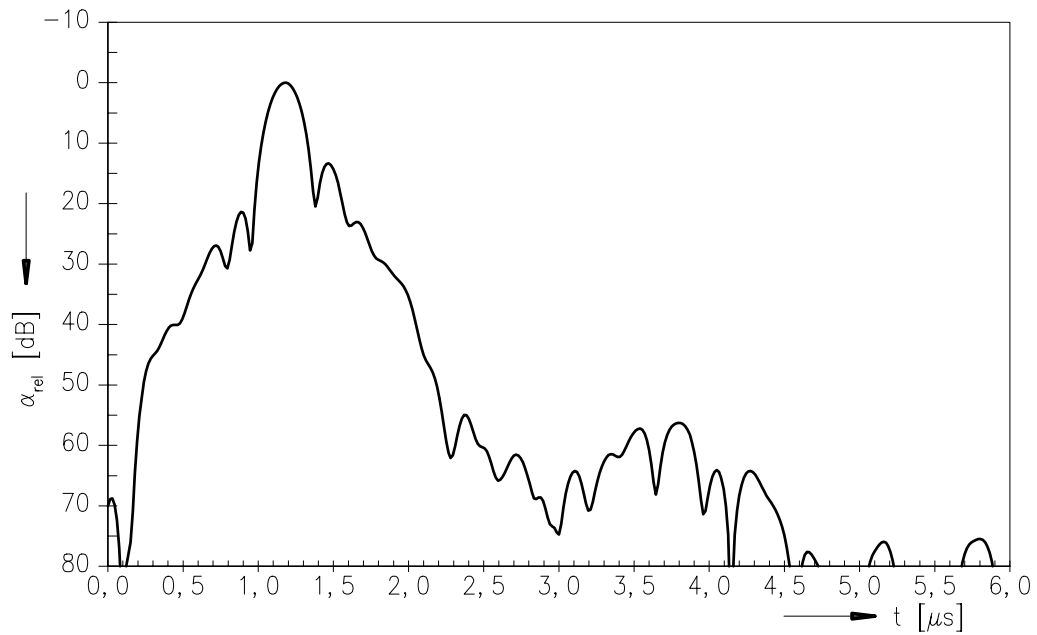



SAW Components

G 3355 K

IF Filter for Quasi/Split Sound Applications

38,90 MHz

Data Sheet

Frequency response of sound channel

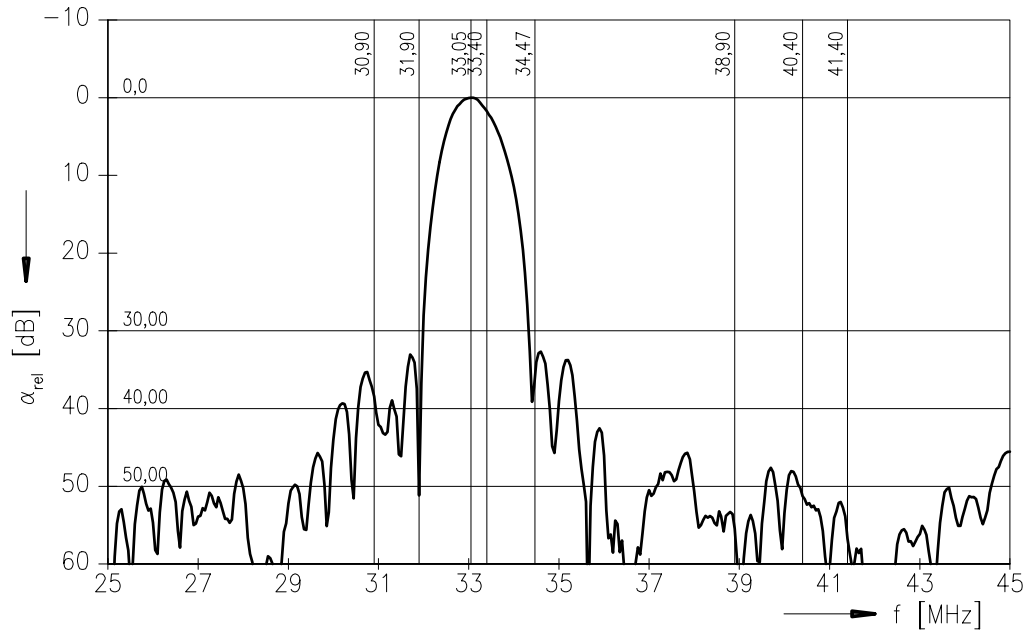



SAW Components

G 3355 K

IF Filter for Quasi/Split Sound Applications

38,90 MHz

Data Sheet

Published by EPCOS AG

Surface Acoustic Wave Components Division, SAW CE MM PD

P.O. Box 80 17 09, D-81617 München

© EPCOS AG 2001. All Rights Reserved.

As far as patents or other rights of third parties are concerned, liability is only assumed for components per se, not for applications, processes and circuits implemented within components or assemblies.

The information describes the type of component and shall not be considered as assured characteristics.

Terms of delivery and rights to change design reserved.

For questions on technology, prices and delivery please contact the sales offices of EPCOS AG or the international representatives.

Due to technical requirements components may contain dangerous substances. For information on the type in question please also contact one of our sales offices.