

PHASE CONTROL THYRISTORS

Hockey Puk Version

Features

- Center amplifying gate
- Metal case with ceramic insulator
- International standard case A-24 (K-PUK)
- High profile hockey-puk

Typical Applications

- DC motor controls
- Controlled DC power supplies
- AC controllers

Major Ratings and Characteristics

Parameters	ST1230C..K	Units	
$I_{T(AV)}$	1745	A	
@ T_{hs}	55	°C	
$I_{T(RMS)}$	3200	A	
@ T_{hs}	25	°C	
I_{TSM}	@ 50Hz	33500	A
	@ 60Hz	35100	A
I^2t	@ 50Hz	5615	KA ² s
	@ 60Hz	5126	KA ² s
V_{DRM}/V_{RRM}	800 to 1600	V	
t_q	typical	200	μs
T_J	- 40 to 125	°C	

1745A

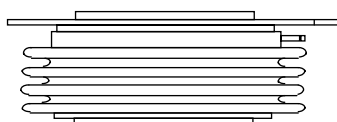

case style A-24 (K-PUK)

ST1230C..K Series

Bulletin I25194 rev. B 01/00

International
 Rectifier

ELECTRICAL SPECIFICATIONS

Voltage Ratings

Type number	Voltage Code	V_{DRM}/V_{RRM} , max. repetitive peak and off-state voltage V	V_{RSM} , maximum non-repetitive peak voltage V	I_{DRM}/I_{RRM} max. @ $T_J = T_J$ max mA
ST1230C..K	08	800	900	100
	12	1200	1300	
	14	1400	1500	
	16	1600	1700	

On-state Conduction

Parameter	ST1230C..K	Units	Conditions	
$I_{T(AV)}$ Max. average on-state current @ Heatsink temperature	1745 (710)	A	180° conduction, half sine wave double side (single side) cooled	
	55 (85)	°C		
$I_{T(RMS)}$ Max. RMS on-state current	3200	A	DC @ 25°C heatsink temperature double side cooled	
I_{TSM} Max. peak, one-cycle non-repetitive surge current	33500		t = 10ms	No voltage reappplied
	35100		t = 8.3ms	reappplied
	28200		t = 10ms	100% V_{RRM}
	29500	t = 8.3ms	reappplied	
I^2t Maximum I^2t for fusing	5615	KA ² s	t = 10ms	No voltage reappplied
	5126		t = 8.3ms	reappplied
	3971		t = 10ms	100% V_{RRM}
	3625		t = 8.3ms	reappplied
$I^2\sqrt{t}$ Maximum $I^2\sqrt{t}$ for fusing	56150	KA ² /s	t = 0.1 to 10ms, no voltage reappplied	
$V_{T(TO)1}$ Low level value of threshold voltage	0.93	V	$(16.7\% \times \pi \times I_{T(AV)} < I < \pi \times I_{T(AV)})$, $T_J = T_J$ max.	
$V_{T(TO)2}$ High level value of threshold voltage	1.02		$(I > \pi \times I_{T(AV)})$, $T_J = T_J$ max.	
r_{t1} Low level value of on-state slope resistance	0.17	mΩ	$(16.7\% \times \pi \times I_{T(AV)} < I < \pi \times I_{T(AV)})$, $T_J = T_J$ max.	
r_{t2} High level value of on-state slope resistance	0.16		$(I > \pi \times I_{T(AV)})$, $T_J = T_J$ max.	
V_{TM} Max. on-state voltage	1.62	V	$I_{pk} = 4000A$, $T_J = T_J$ max, $t_p = 10ms$ sine pulse	
I_H Maximum holding current	600	mA	$T_J = 25^\circ C$, anode supply 12V resistive load	
I_L Typical latching current	1000			

Switching

Parameter	ST1230C..K	Units	Conditions
di/dt Max. non-repetitive rate of rise of turned-on current	1000	A/μs	Gate drive 20V, 20Ω, t _r ≤ 1μs T _J = T _J max, anode voltage ≤ 80% V _{DRM}
t _d Typical delay time	1.9	μs	Gate current 1A, di _g /dt = 1A/μs V _d = 0.67% V _{DRM} , T _J = 25°C
t _q Typical turn-off time	200		I _{TM} = 550A, T _J = T _J max, di/dt = 40A/μs, V _R = 50V dv/dt = 20V/μs, Gate 0V 100Ω, t _p = 500μs

Blocking

Parameter	ST1230C..K	Units	Conditions
dv/dt Maximum critical rate of rise of off-state voltage	500	V/μs	T _J = T _J max. linear to 80% rated V _{DRM}
I _{RRM} I _{DRM} Max. peak reverse and off-state leakage current	100	mA	T _J = T _J max, rated V _{DRM} /V _{RRM} applied

Triggering

Parameter	ST1230C..K		Units	Conditions
P _{GM} Maximum peak gate power	16		W	T _J = T _J max, t _p ≤ 5ms
P _{G(AV)} Maximum average gate power	3			T _J = T _J max, f = 50Hz, d% = 50
I _{GM} Max. peak positive gate current	3.0		A	T _J = T _J max, t _p ≤ 5ms
+V _{GM} Maximum peak positive gate voltage	20		V	T _J = T _J max, t _p ≤ 5ms
-V _{GM} Maximum peak negative gate voltage	5.0			
I _{GT} DC gate current required to trigger	TYP.	MAX.	mA	T _J = - 40°C T _J = 25°C T _J = 125°C Max. required gate trigger/ current/ voltage are the lowest value which will trigger all units 12V anode-to-cathode applied
	200	-		
	100	200		
V _{GT} DC gate voltage required to trigger	1.4	-	V	T _J = - 40°C T _J = 25°C T _J = 125°C
	1.1	3.0		
	0.9	-		
I _{GD} DC gate current not to trigger	10		mA	T _J = T _J max Max. gate current/voltage not to trigger is the max. value which will not trigger any unit with rated V _{DRM} anode-to-cathode applied
V _{GD} DC gate voltage not to trigger	0.25			

ST1230C..K Series

Bulletin I25194 rev. B 01/00

International
IRF Rectifier

Thermal and Mechanical Specification

Parameter	ST1230C..K	Units	Conditions
T _J Max. operating temperature range	-40 to 125	°C	
T _{stg} Max. storage temperature range	-40 to 150		
R _{thJ-hs} Max. thermal resistance, junction to heatsink	0.042 0.021	K/W	DC operation single side cooled DC operation double side cooled
R _{thC-hs} Max. thermal resistance, case to heatsink	0.006 0.003	K/W	DC operation single side cooled DC operation double side cooled
F Mounting force, ± 10%	24500 (2500)	N (Kg)	
wt Approximate weight	425	g	
Case style	A-24 (K-PUK)		See Outline Table

ΔR_{thJ-hs} Conduction

(The following table shows the increment of thermal resistance R_{thJ-hs} when devices operate at different conduction angles than DC)

Conduction angle	Sinusoidal conduction		Rectangular conduction		Units	Conditions
	Single Side	Double Side	Single Side	Double Side		
180°	0.003	0.003	0.002	0.002	K/W	T _J = T _J max.
120°	0.004	0.004	0.004	0.004		
90°	0.005	0.005	0.005	0.005		
60°	0.007	0.007	0.007	0.007		
30°	0.012	0.012	0.012	0.012		

Ordering Information Table

Device Code							
ST	123	0	C	16	K	1	
①	②	③	④	⑤	⑥	⑦	⑧
1	- Thyristor	2	- Essential part number	3	- 0 = Converter grade	4	- C = Ceramic Puk
5	- Voltage code: Code x 100 = V _{RRM} (See Voltage Rating Table)	6	- K = Puk Case A-24 (K-PUK)	7	- 0 = Eyelet terminals (Gate and Auxiliary Cathode Unsoldered Leads) 1 = Fast-on terminals (Gate and Auxiliary Cathode Unsoldered Leads) 2 = Eyelet terminals (Gate and Auxiliary Cathode Soldered Leads) 3 = Fast-on terminals (Gate and Auxiliary Cathode Soldered Leads)	8	- Critical dv/dt: None = 500V/μsec (Standard selection) L = 1000V/μsec (Special selection)

Outline Table

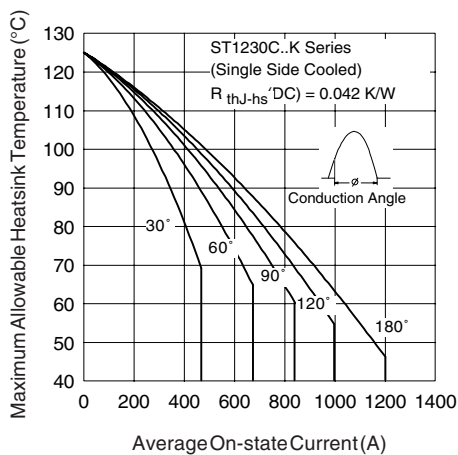
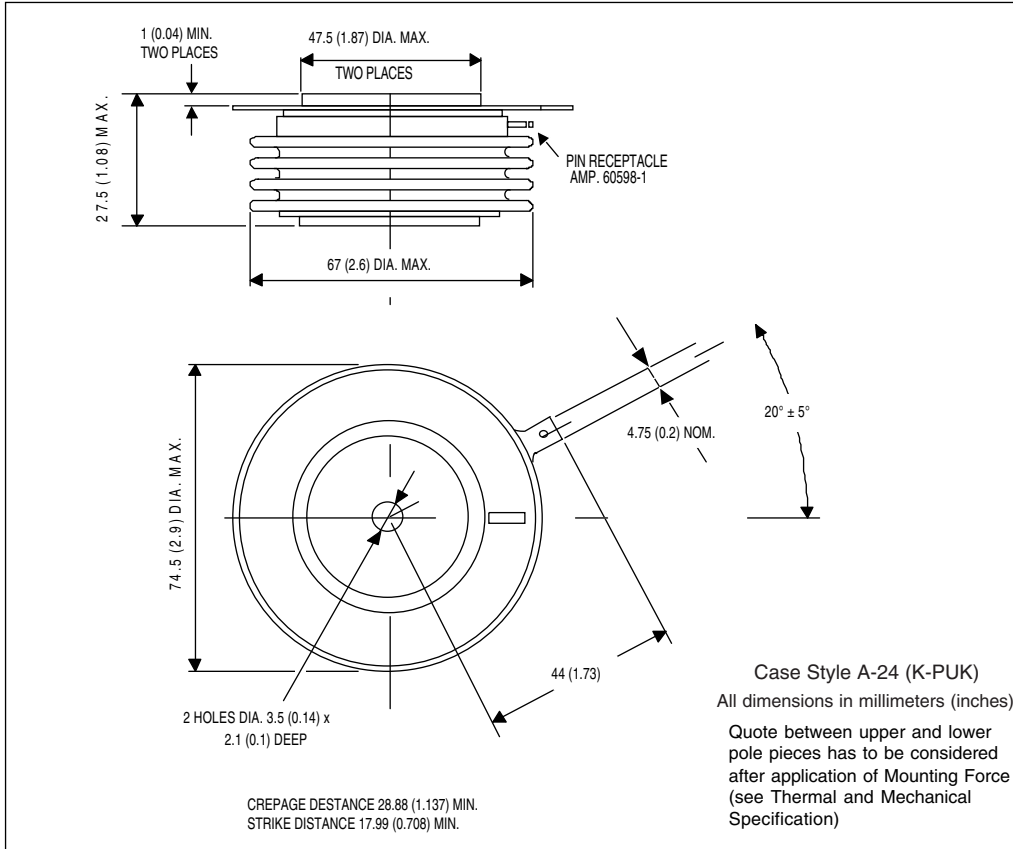

Fig. 1 - Current Ratings Characteristics

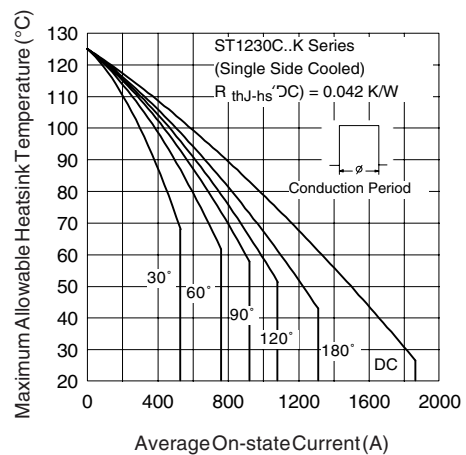

Fig. 2 - Current Ratings Characteristics

ST1230C..K Series

Bulletin I25194 rev. B 01/00

International
IRF Rectifier

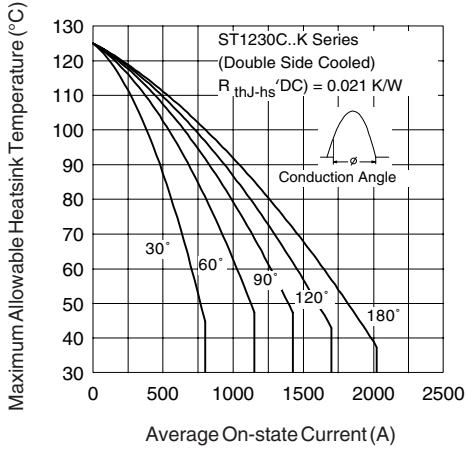

Fig. 3 - Current Ratings Characteristics

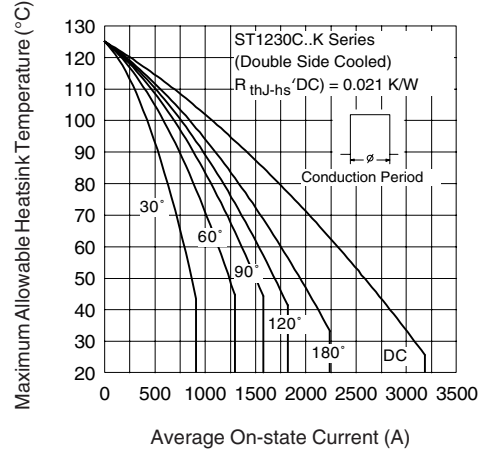

Fig. 4 - Current Ratings Characteristics

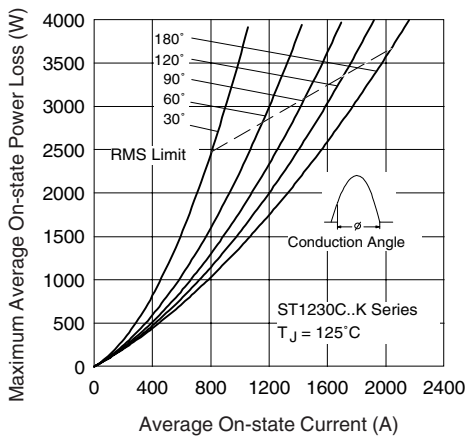

Fig. 5 - On-state Power Loss Characteristics

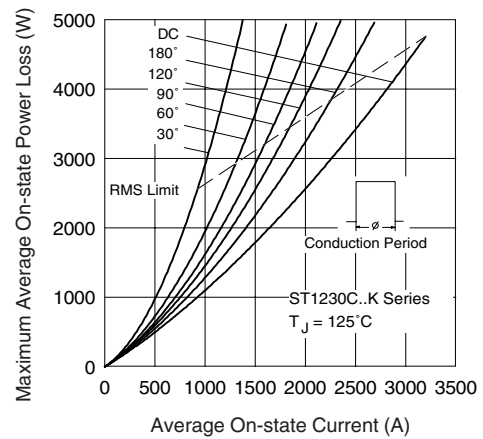

Fig. 6 - On-state Power Loss Characteristics

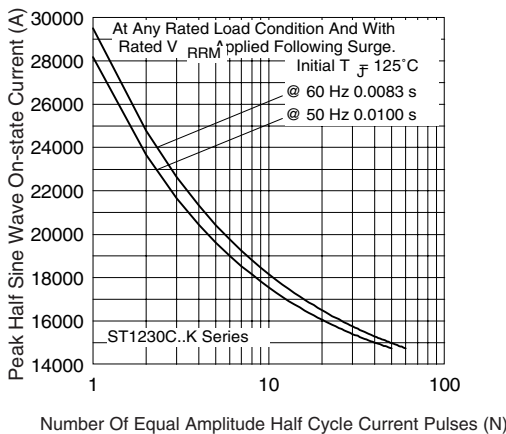

Fig. 7 - Maximum Non-Repetitive Surge Current Single and Double Side Cooled

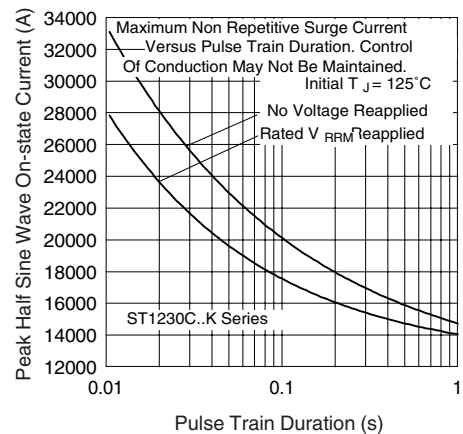

Fig. 8 - Maximum Non-Repetitive Surge Current Single and Double Side Cooled

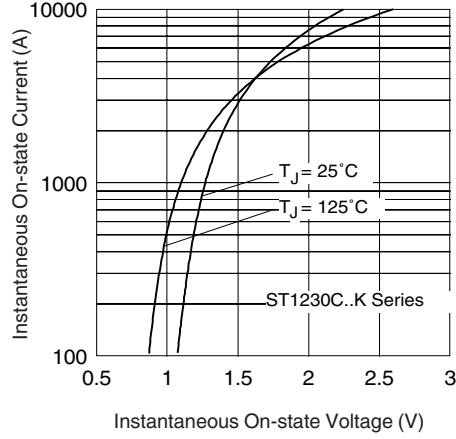

Fig. 9 - On-state Voltage Drop Characteristics

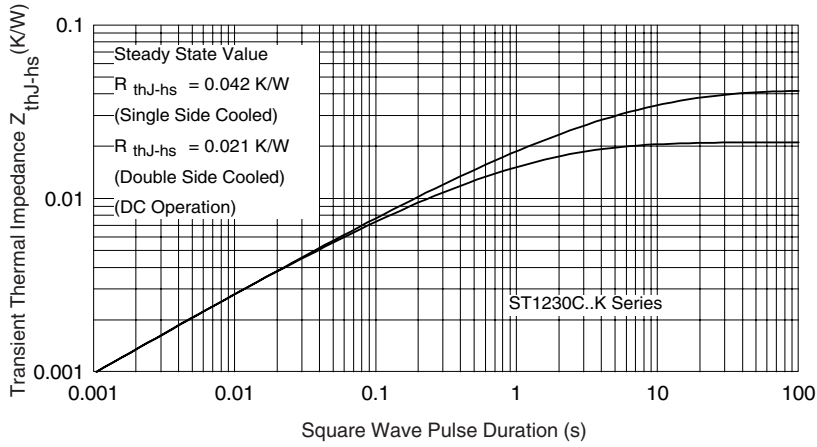

Fig. 10 - Thermal Impedance Z_{thJ-hs} Characteristics

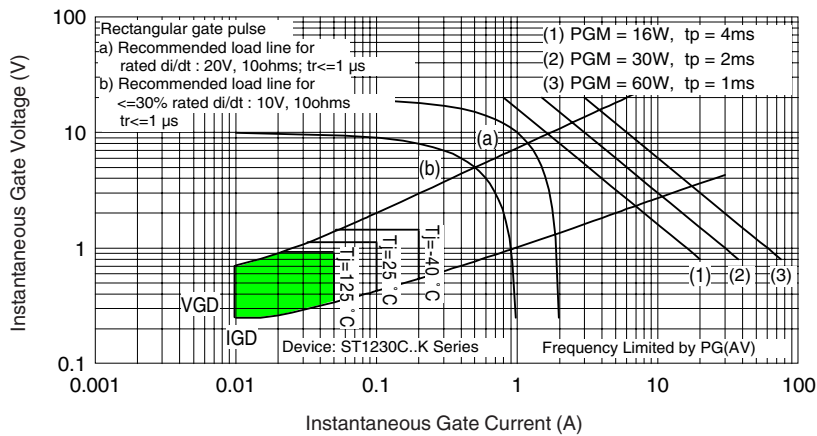

Fig. 11 - Gate Characteristics