

## DESCRIPTION

The RH1013M is the first precision dual operational amplifier which directly upgrades designs in the industry standard 8-pin DIP LM158/MC1558/OP-221 pin configuration. Low offset voltage (300 $\mu$ V max), low drift ( 2.5 $\mu$ V/ $^{\circ}$ C), low offset current ( 1.5nA), and high gain (1.2 million min) combine to make the RH1013M two truly precision amplifiers in one package.

The wafer lots are processed to Linear Technology's in-house Class S flow to yield circuits usable in stringent military applications.

## ABSOLUTE MAXIMUM RATINGS

Supply Voltage .....	$\pm 22$ V
Differential Input Voltage .....	$\pm 30$ V
Input Voltage .....	Equal to Positive Supply Voltage
.....	5V Below Negative Supply Voltage
Output Short-Circuit Duration .....	Indefinite
Operating Temperature Range .....	$-55^{\circ}$ C to $125^{\circ}$ C
Storage Temperature Range .....	$-65^{\circ}$ C to $150^{\circ}$ C
Lead Temperature (Soldering, 10 sec) .....	$300^{\circ}$ C

 LTC and LT are registered trademarks of Linear Technology Corporation.

## BURN-IN CIRCUIT

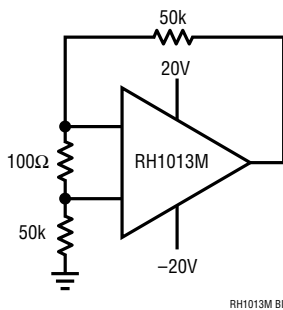

## TOTAL DOSE BIAS CIRCUIT

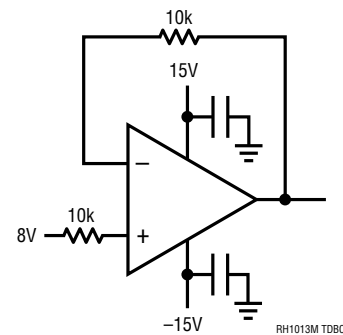

## PACKAGE/ORDER INFORMATION

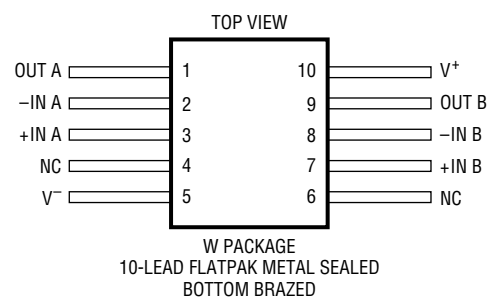
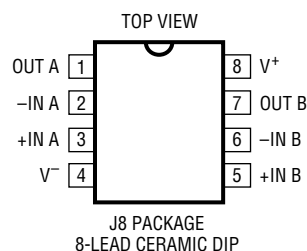
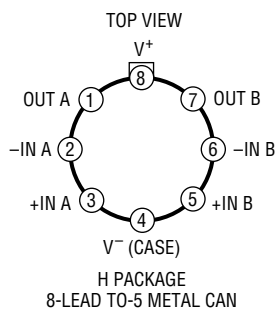

**TABLE 1: ELECTRICAL CHARACTERISTICS** (Preirradiation) $V_S = \pm 15V$ ,  $V_{CM} = 0V$ , unless otherwise noted.

SYMBOL	PARAMETER	CONDITIONS	NOTES	$T_A = 25^\circ C$			SUB-GROUP	$-55^\circ C$ $T_A$ $125^\circ C$			SUB-GROUP	UNITS	
				MIN	TYP	MAX		MIN	TYP	MAX			
$V_{OS}$	Input Offset Voltage	$V_{CM} = 0.1V$ , $T_A = 125^\circ C$				300	1		550	2,3	$\mu V$		
			2			450	1		750	3	$\mu V$		
									750	2	$\mu V$		
$\frac{V_{OS}}{Temp}$	Average Tempco of Offset Voltage		1					2.5			$\mu V/^\circ C$		
$\frac{V_{OS}}{Time}$	Long Term $V_{OS}$ Stability				0.5						$\mu V/Mo$		
$I_{OS}$	Input Offset Current					10	1		20	2,3	nA		
			2			10	1		20	2,3	nA		
$I_B$	Input Bias Current					30	1		45	2,3	nA		
			2			50	1		120	2,3	nA		
$e_n$	Input Noise Voltage	0.1Hz to 10Hz			0.55						$\mu V_{P-P}$		
	Input Noise Voltage Density	$f_0 = 10Hz$			24						nV/ Hz		
		$f_0 = 1000Hz$				22						nV/ Hz	
$i_n$	Input Noise Current Density	$f_0 = 10Hz$			0.07						pA/ Hz		
$R_{IN}$	Input Resistance	Differential Common Mode	1		70						M		
					4						G		
$A_{VOL}$	Large-Signal Voltage Gain	$V_0 = \pm 10V$ , $R_L = 10k$			1.2		4	0.25		5,6	V/ $\mu V$		
		$V_0 = \pm 10V$ , $R_L = 600$			0.5		4				V/ $\mu V$		
		$V_0 = 5mV$ to $4V$ , $R_L = 500$	2		1							V/ $\mu V$	
	Input Voltage Range		1		13.5							V	
			1		-15.0								V
			1,2		3.5								V
			1,2		0								V
CMRR	Common-Mode Rejection Ratio	$V_{CM} = 13.5V$ , $-15V$			97		1					dB	
		$V_{CM} = 13V$ , $-14.9V$						94		2,3		dB	
PSRR	Power Supply Rejection Ratio	$V_S = \pm 10V$ to $\pm 18V$			100		1	97		2,3		dB	
	Channel Separation	$V_0 = \pm 10V$ , $R_L = 2k$			120		1					dB	
$V_{OUT}$	Output Voltage Swing	$R_L = 2k$			$\pm 12.5$		4	$\pm 11.5$		5,6		V	
		Output Low, No Load	2		25		4					mV	
		Output Low, 600 to GND	2		10		4		18	5,6		mV	
		Output Low, $I_{SINK} = 1mA$	2		350		4					mV	
		Output High, No Load	2		4.0		4						V
		Output High, 600 to GND	2		3.4		4		3.1	5,6			V
SR	Slew Rate				0.2		4					V/ $\mu s$	
$I_S$	Supply Current	Per Amplifier			0.55		1		0.70	2,3		mA	
			2		0.50		1		0.65	2,3		mA	

**TABLE 1A: ELECTRICAL CHARACTERISTICS** (Postirradiation) $V_S = \pm 15V$ ,  $V_{CM} = 0V$ ,  $T_A = 25^\circ C$ , unless otherwise noted.

SYMBOL	PARAMETER	CONDITIONS	NOTES	10KRAD(Si)		20KRAD(Si)		50KRAD(Si)		100KRAD(Si)		200KRAD(Si)		UNITS
				MIN	MAX	MIN	MAX	MIN	MAX	MIN	MAX	MIN	MAX	
$V_{OS}$	Input Offset Voltage				450		450		600		750		900	$\mu V$
			2		600		600		750		900			$\mu V$
$I_{OS}$	Input Offset Current				10		10		15		20		25	nA
			2		10		10		15		20			nA
$I_B$	Input Bias Current				60		75		100		175		250	nA
			2		80		100		125		200			nA
	Input Voltage Range		1	13.5		13.5		13.5		13.5		13.5		V
			1	-15.0		-15.0		-15.0		-15.0		-15.0		V
			2	3.5		3.5		3.5		3.5				V
			2	0		0		0		0				V
CMRR	Common-Mode Rejection Ratio	$V_{CM} = 13V, -15V$		97		97		94		90		86		dB
PSRR	Power Supply Rejection Ratio	$V_S = \pm 5V$ to $\pm 18V$		100		98		94		86		80		dB
$A_{VOL}$	Large-Signal Voltage Gain	$R_L = 10k, V_O = \pm 10V$		500		200		100		50		25		V/mV
$V_{OUT}$	Maximum Output Voltage Swing	$R_L = 10k$		$\pm 12.5$		$\pm 12.5$		$\pm 12.5$		$\pm 12.5$		$\pm 12.5$		V
			2		25		30		40		50			mV
			2		10		10		10		10			mV
			2		0.6		0.8		1.0		1.6			V
			2		4.0		4.0		4.0		4.0			V
			2		3.4		3.2		3.0		2.8			V
SR	Slew Rate	$R_L = 10k$		0.13		0.12		0.11		0.07		0.01		V/ $\mu s$
$I_S$	Supply Current	Per Amplifier			0.55		0.55		0.55		0.55		0.55	mA
			2		0.50		0.50		0.50		0.50			mA

**Note 1:** Guaranteed by design, characterization, or correlation to other tested parameters..

**Note 2:** Specification applies for  $V_S^+ = 5V$ ,  $V_S^- = 0V$ ,  $V_{CM} = 0V$ ,  $V_{OUT} = 1.4V$ .

**TABLE 2: ELECTRICAL TEST REQUIREMENTS**

MIL-STD-883 TEST REQUIREMENTS	SUBGROUP
Final Electrical Test Requirements (Method 5004)	1*,2,3,4,5,6
Group A Test Requirements (Method 5005)	1,2,3,4,5,6
Group B and D for Class S, and Group C and D for Class B End Point Electrical Parameters (Method 5005)	1,2,3

\* PDA applies to subgroup 1. See PDA Test Notes.

**PDA Test Notes**

The PDA is specified as 5% based on failures from group A, subgroup 1, tests after cooldown as the final electrical test in accordance with method 5004 of MIL-STD-883. The verified failures of group A, subgroup 1, after burn-in divided by the total number of devices submitted for burn-in in that lot shall be used to determine the percent for the lot.

Linear Technology Corporation reserves the right to test to tighter limits than those given.

**TYPICAL PERFORMANCE CHARACTERISTICS**

**Supply Current (Per Amplifier)**

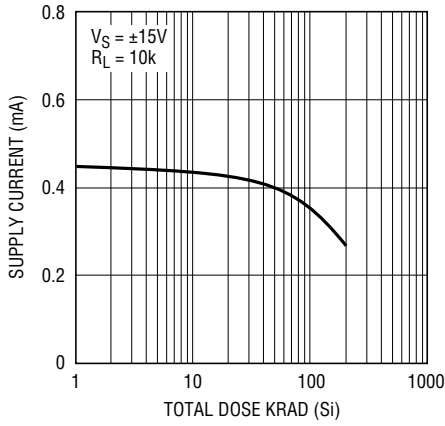

RH1013M G01

**Positive Slew Rate**

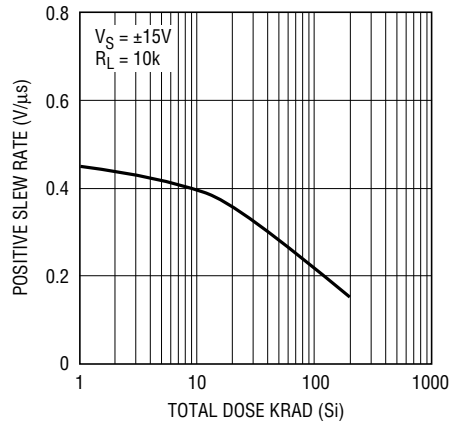

RH1013M G02

**Negative Slew Rate**

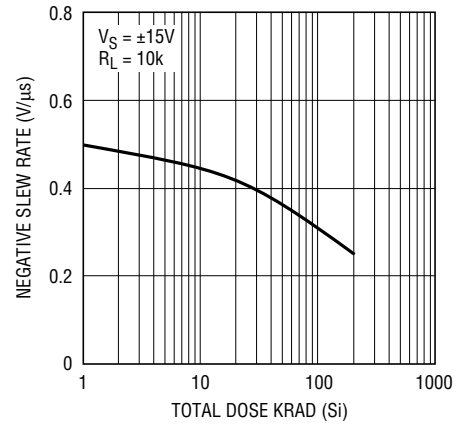

RH1013M G03

**Input Offset Voltage**

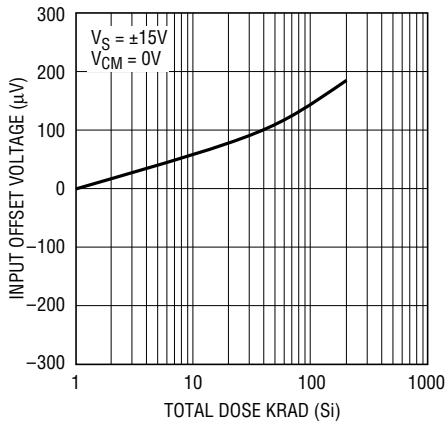

RH1013M G04

**Input Bias Current**

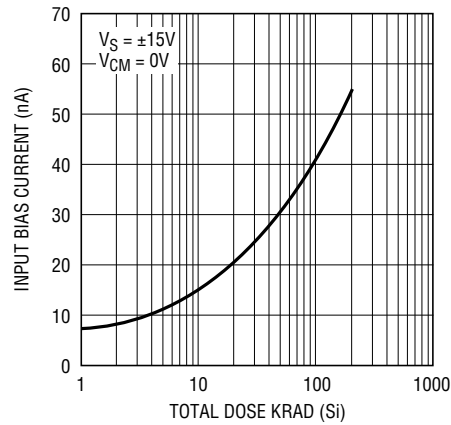

RH1013M G05

**Input Offset Current**

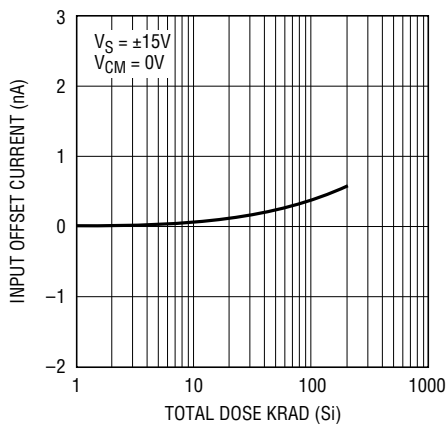

RH1013M G06

**Open-Loop Gain**

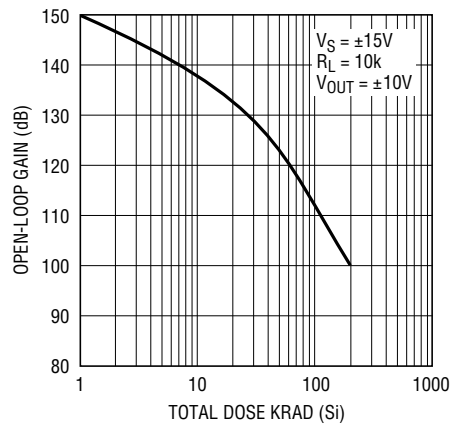

RH1013M G07

## TYPICAL PERFORMANCE CHARACTERISTICS

### Common-Mode Rejection Ratio

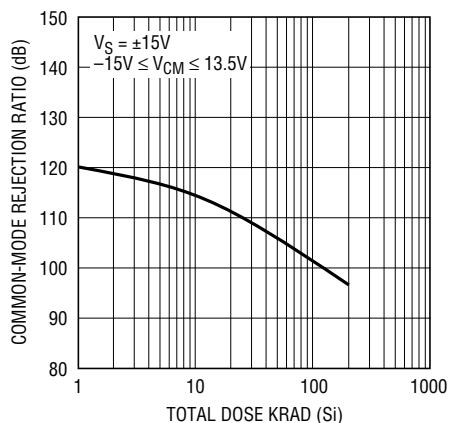

RH1013M G08

### Power Supply Rejection Ratio

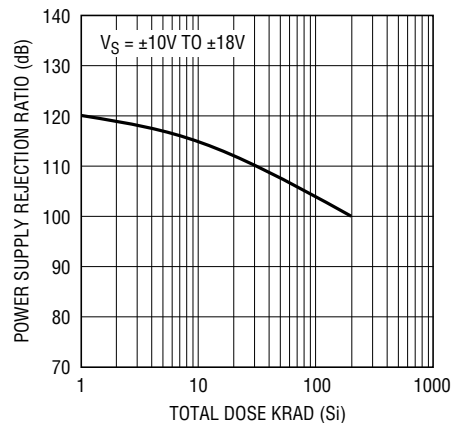

RH1013M G09

### Input Noise Voltage Density

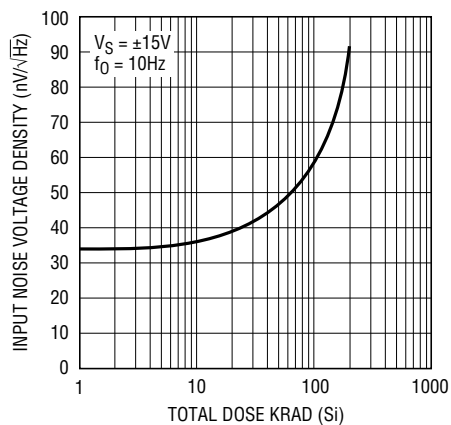

RH1013M G10

### Gain Bandwidth Product

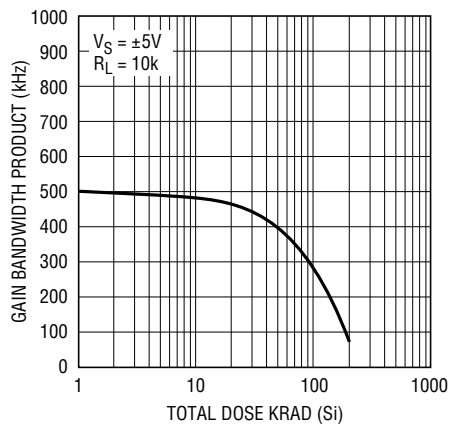

RH1013M G11

## Microcircuit Part Numbering System

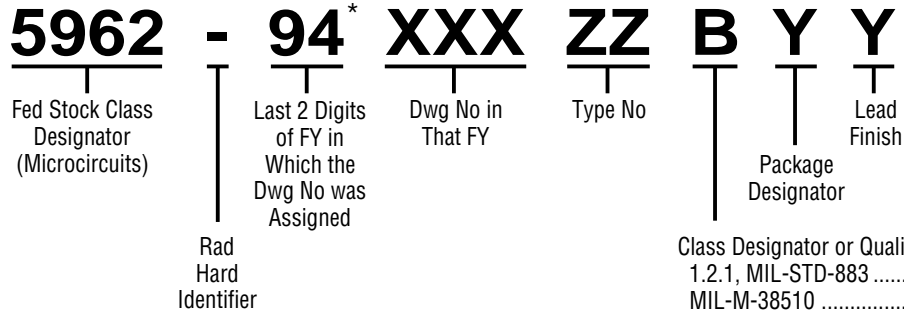

\* For existing MIL-M-38510 associated detail specification sheet, the "Last 2 Digits of FY" and drawing number will consist of first two digits of MIL-M-38510 (i.e., 38) followed by the three digit identifier assigned to the detail sheet (i.e., g/339).

### Operational Amplifiers

<b>Generic</b>	<b>SMD 5962-</b>
LT <sup>®</sup> 1001AMH, J8	8773803GA, PA
LT1001MH, J8	8773801GA, PA
LT1002AMJ	8771501CA
LT1006AMH, J8	8993301MGA, PA
LT1006MH, J8	8993302MGA, PA
LT1007AMH, J8	8757801GA, PA
LT1012AMH, D	9084202MGA, PA
LT1012MH, D	9084201MGA, PA
LT1013AMH, J8	8876001GA, PA
LT1013MH, J8	8876002GA, PA
LT1014AMJ	8967701CA
LT1014MJ	8967702CA
LT1028AMH, J8	8862202GA, PA
LT1028MH, J8	8862201GA, PA
LT1037AMH, J8	8856701GA, PA
LT1055AMH	8997601GA
LT1055MH	8997603GA
LT1056AMH	8997602GA
LT1056MH	8997604GA
LT1057AMH, J8	9081701MGA, PA
LT1057MH, J8	9081702MGA, PA
LT1058AMJ, L	8989701CA, XA
LT1058MJ	8989702CA
LT1078AMH	9163204MGA
LT1078AMJ8	9163206MPA
LT1078MH	9163203MGA
LT1078MJ8	9163203MPA
LT1079AMJ	9163202MCA
LT1079MJ	9163201MCA
LT1124AMJ8	9323804MPA
LT1124MJ8	9323802MPA
LT1125AMJ	9323803MCA
LT1125MJ	9323801MCA
LT1172MJ8	9207901MPA
LTC1051MH, J8	9460001MGA, PA
LTC1051AMH, J8	9460002MGA, PA
LTC1052MJ8, H, J	8978201PA, GA, CA

### High Speed Op Amps

<b>Generic</b>	<b>SMD 5962-</b>
LT1022AMH	8962201GA
LT1022MH	8962202GA
LT1028AMH, J8	8862202GA, PA
LT1028MH, J8	8862201GA, PA
LT1037AMH, J8	8856701GA, PA
LT1056AMH	8997602GA
LT1056MH	8997604GA
LT1057AMH, J8	9081701MGA, PA
LT1057MH, J8	9081702MGA, PA
LT1058AMJ, L	8989701CA, XA
LT1058MJ	8989702CA
LT118AMJ8	9451601MPA
LT1229MJ8	9318401MPA
LT1230MJ	9318402MCA

### Buffer Amplifiers

<b>Generic</b>	<b>SMD 5962-</b>
LT1010MH, K	8856201XA, YA

### Analog-to-Digital Converters

<b>Generic</b>	<b>SMD 5962-</b>
LTC <sup>®</sup> 1291CMJ8	9305701MPA
LTC1292CMJ8	9305702MPA
LTC1293CMJ	9305703MEA
LTC1294CMJ	9305704MRA

### Regulators

<b>Generic</b>	<b>SMD 5962-</b>
LT1003MK	8987301XA
LT1020MJ	9084101MCA
LT1033MK	8874101XA
LT1076HVMK	9311902MYA
LT1076MK	9311901MYA
LT1083MK-5	9073901MXA
LT1084MK	8952101XA
LT1084MK-5	9073902MXA
LT1085MK	8864601XA
LT1085MK-5	9073903MXA
LT1086MK, H	8998101XA, YA
LT1086MK-5	9073904MXA
LT1120MJ8	9322401MPA
LT1185MK	9469501MXA

### References

<b>Generic</b>	<b>SMD 5962-</b>
LT1004MH-1.2	8859701XA
LT1004MH-2.5	8859702XA
LT1009MH	8961001XA
LT1019AMH-10	9059501GA
LT1019AMH-5	9059502GA
LT1019AMH-4.5	9059503GA
LT1019AMH-2.5	9059504GA
LT1019MH-10	9059505GA
LT1019MH-5	9059506GA
LT1019MH-4.5	9059507GA
LT1019MH-2.5	9059508GA
LT1021BMH-10	8860001GA
LT1021BMH-5	8876201GA
LT1021BMH-7	8864701GA
LT1021CMH-10	8860002GA
LT1021CMH-5	8876202GA
LT1021DMH-10	8860003GA
LT1021DMH-5	8876203GA
LT1021DMH-7	8864702GA
LT1029AMH	9051901XA
LT1029MH	9051902XA
LT1031BMH	8980201XA
LT1031CMH	8980202XA
LT1031DMH	8980203XA
LT580SH	8686101XA
LT580TH	8686102XA

### Comparators

<b>Generic</b>	<b>SMD 5962-</b>
LT1010MH, K	8856201XA, YA
LT1011AMH, J8	9062701GA, PA
LT1011MH, J8	9062702GA, PA
LT1016MH, J8	8684501IA, PA
LT1017MH, J8	8950401GA, PA
LT1018MH, J8	8950402GA, PA
LTC1041MJ8	9470901MPA

### Switching Regulators

<b>Generic</b>	<b>SMD 5962-</b>
LT1070HVMK	9082504MYA
LT1070MK	9082501MYA
LT1071HVMK	9082505MYA
LT1071MK	9082502MYA
LT1072HVMK	9082506MYA
LT1072MJ8, K	9082503MPA, YA
LT1074MK	9457601MYA
LT1074HVMK	9457602MYA
LT1111MJ8	9321201MPA
LTC1052MH, J8, J	8978201GA, PA, CA

### Switching Power Supply Controllers

<b>Generic</b>	<b>SMD 5962-</b>
LT1241MJ8	9319001MPA
LT1242MJ8	9319002MPA
LT1243MJ8	9319003MPA
LT1244MJ8	9319004MPA
LT1245MJ8	9319005MPA

### Interface Products

<b>Generic</b>	<b>SMD 5962-</b>
LT1039MJ16, J	8875102EA, VA
LT1080MJ	8766601VA
LT1081MJ	8766602EA
LT1180MJ	9172901MVA
LT1181MJ	9172902MEA
LT1280MJ	9172903MVA
LT1281MJ	9172904MEA
LTC1045MJ	9054501RA
LTC485MJ8	9208001MPA

### Filters

<b>Generic</b>	<b>SMD 5962-</b>
LTC1060AMJ	8864101RA
LTC1062MJ8	9159501MPA
LTC1064-1AMJ	9069302MCA
LTC1064-1MJ	9069301MCA
LTC1064-4MJ, L	9064901EA, XA
LTC1064MJ	8948301CA

**Rad Hard**

This table provides example specifications for our Rad Hard products. For complete Rad Hard data sheets, contact 1-800-4-LINEAR.

DEVICE	SYMBOL	CONDITIONS	10Krad (Si)		20Krad (Si)		50Krad (Si)		80Krad (Si)		100Krad (Si)		200Krad (Si)		UNITS	PACKAGE OPTIONS
			MIN	MAX	MIN	MAX	MIN	MAX	MIN	MAX	MIN	MAX	MIN	MAX		
RH07	$V_{OS}$ $I_{OS}$		90 2.8	150 4	200 8					250 12	300 20	$\mu V$ nA	J8, H			
RH27C	$V_{OS}$ $I_{OS}$		100 75	130 75	180 90					280 120	400 180	$\mu V$ nA	H, W			
RH37C	$V_{OS}$ $I_{OS}$		100 75	130 75	180 90					280 120	400 180	$\mu V$ nA	H, W			
RH101A	$V_{OS}$ $I_{OS}$		2 10	2 10	2 10					2 10	3 20	mV nA	H, W			
RH108A	$V_{OS}$ $I_{OS}$		0.5 0.2	0.5 0.2	0.5 0.2			1.0 0.2				mV nA	H, W			
RH117	$V_{REF}$	3V ( $V_{IN} - V_{OUT}$ ) 40V 10mA $I_{OUT}$ $I_{MAX}$ , P P MAX	1.20 1.30	1.20 1.30	1.20 1.30					1.20 1.30		V	H, K			
RH118	$V_{OS}$ SR	$V_S = \pm 15V, A_V = 1$	50 4	50 4	50 4					50 4	50 10	mV V/ $\mu s$	H, W			
RH119	$V_{OS}$ $I_{OS}$		4 75	4 100	4 150					4 300	8 500	mV nA	H, J, W			
RH129	$V_Z$ V Z/ TEMP	RH129A RH129B RH129C	6.7 7.2 10 20 50	6.7 7.2 10 20 50	6.7 7.2 10 20 50					6.7 7.2 15 25 55	6.7 7.2 20 30 60	V ppm/ $^{\circ}C$ ppm/ $^{\circ}C$ ppm/ $^{\circ}C$	H			
RH137	$V_{REF}$	$ V_{IN} - V_{OUT} $ 5V, $I_{OUT} = 10mA$ 3V $ V_{IN} - V_{OUT} $ 40V 10mA $I_{OUT}$ $I_{MAX}$ , P P MAX	-1.225 -1.275 -1.2 -1.3	-1.225 -1.275 -1.2 -1.3	-1.225 -1.275 -1.2 -1.3					-1.225 -1.275 -1.2 -1.3	-1.22 -1.23 -1.2 -1.3	V V	K, H			
RH1009	$V_Z$ V Z/ $I_Z$		2.495 2.505 6	2.495 2.505 6	2.495 2.505 8					2.495 2.505 10	2.495 2.505 12	V mV	H			
RH1011	$V_{OS}$ $I_{OS}$		1.5 4	1.5 4	1.5 4					1.5 20	2 50	mV nA	H, J8, W			
RH1013	$V_{OS}$ $I_{OS}$		450 10	450 10	600 15					750 20	900 25	$\mu V$ nA	H, J8, W			
RH1014	$V_{OS}$ $I_{OS}$		450 10	450 10	600 15					750 20	900 25	$\mu V$ nA	J, W			
RH1021-5	$V_{OUT}$ TCV <sub>OUT</sub>	RH1021CM-5 RH1021BM-5, DM-5 RH1021BM-5 RH1021CM-5, DM-5	4.9975 5.0025 4.95 5.05 5 20	4.995 5.005 4.945 5.055 5 20	4.993 5.007 4.942 5.058 5 20					4.9925 5.008 4.94 5.06 7 22	4.99 5.01 4.935 5.065 10 25	V V ppm/ $^{\circ}C$ ppm/ $^{\circ}C$	H			
RH1021-7	$V_{OUT}$ TCV <sub>OUT</sub>	RH1021BM-7 RH1021DM-7	6.95 7.05 5 20	6.95 7.05 5 20	6.95 7.05 5 20					6.94 7.06 7 22	6.93 7.07 10 25	V ppm/ $^{\circ}C$ ppm/ $^{\circ}C$	H			
RH1021-10	$V_{OUT}$ TCV <sub>OUT</sub>	RH1021CM-10 RH1021BM-10, DM-10 RH1021BM-10 RH1021CM-10, DM-10	9.995 10.005 9.95 10.05 5 20	9.99 10.01 9.945 10.055 5 20	9.987 10.013 9.942 10.06 5 20					9.985 10.015 9.98 10.06 7 22	9.98 10.02 9.935 10.065 10 25	V V ppm/ $^{\circ}C$ ppm/ $^{\circ}C$	H			
RH1056A	$V_{OS}$ $I_{OS}$		180 $\pm 10$	180 $\pm 50$	250 $\pm 150$					450 $\pm 250$	450 $\pm 350$	$\mu V$ pA	H, W			
RH1078	$V_{OS}$ $I_{OS}$		350 2	500 18	650 13	75k 800 75k 18				1000 23		$\mu V$ nA	H, J8, W J, W			
RH1086	$V_{REF}$ Dropout V	$I_{OUT} = 10mA$ $10mA \leq I_{OUT} \leq I_{FULL LOAD}$ $1.5V \leq (V_{IN} - V_{OUT}) \leq 15V$ $\Delta V_{REF} = 1\%, I_{OUT} = 1.5A (K)$ $\Delta V_{REF} = 1\%, I_{OUT} = 0.5A (H)$	1.258 1.271 1.5	1.257 1.269 1.51	1.253 1.265 1.52					1.247 1.260 1.55	1.241 1.253 1.575	V V V	H, K			

## U.S. Area Sales Offices

### NORTHEAST REGION

**Linear Technology Corporation**  
3220 Tillman Drive, Suite 120  
Bensalem, PA 19020  
Phone: (215) 638-9667  
FAX: (215) 638-9764

### Linear Technology Corporation

266 Lowell Street, Suite B-8  
Wilmington, MA 01887  
Phone: (508) 658-3881  
FAX: (508) 658-2701

### NORTHWEST REGION

#### Linear Technology Corporation

1900 McCarthy Blvd., Suite 205  
Milpitas, CA 95035  
Phone: (408) 428-2050  
FAX: (408) 432-6331

### SOUTHEAST REGION

#### Linear Technology Corporation

17000 Dallas Parkway, Suite 219  
Dallas, TX 75248  
Phone: (214) 733-3071  
FAX: (214) 380-5138

#### Linear Technology Corporation

5510 Six Forks Road, Suite 102  
Raleigh, NC 27609  
Phone: (919) 870-5106  
FAX: (919) 870-8831

### CENTRAL REGION

#### Linear Technology Corporation

Chesapeake Square  
229 Mitchell Court, Suite A-25  
Addison, IL 60101  
Phone: (708) 620-6910  
FAX: (708) 620-6977

### SOUTHWEST REGION

#### Linear Technology Corporation

21243 Ventura Blvd., Suite 227  
Woodland Hills, CA 91364  
Phone: (818) 703-0835  
FAX: (818) 703-0517

#### Linear Technology Corporation

15375 Barranca Parkway, Suite A-211  
Irvine, CA 92718  
Phone: (714) 453-4650  
FAX: (714) 453-4765

## International Sales Offices

### FRANCE

#### Linear Technology S.A.R.L.

Immeuble "Le Quartz"  
58 Chemin de la Justice  
92290 Chatenay Malabry  
France  
Phone: 33-1-41079555  
FAX: 33-1-46314613

### KOREA

#### Linear Technology Korea Co., Ltd

Namsong Building, #403  
Itaewon-Dong 260-199  
Yongsan-Ku, Seoul 140-200  
Korea  
Phone: 82-2-792-1617  
FAX: 82-2-792-1619

### TAIWAN

#### Linear Technology Corporation

Rm. 602, No. 46, Sec. 2  
Chung Shan N. Rd.  
Taipei, Taiwan, R.O.C.  
Phone: 886-2-521-7575  
FAX: 886-2-562-2285

### GERMANY

#### Linear Technology GmbH

Oskar-Messter-Str. 24  
85737 Ismaning  
Germany  
Phone: 49-89-962455-0  
FAX: 49-89-963147

### SINGAPORE

#### Linear Technology Pte. Ltd.

507 Yishun Industrial Park A  
Singapore 2776  
Phone: 65-753-2692  
FAX: 65-754-4113

### UNITED KINGDOM

#### Linear Technology (UK) Ltd.

The Coliseum, Riverside Way  
Camberley, Surrey GU15 3YL  
United Kingdom  
Phone: 44-1276-677676  
FAX: 44-1276-64851

### JAPAN

#### Linear Technology KK

5F NAO Bldg.  
1-14 Shin-Ogawa-cho Shinjuku-ku  
Tokyo, 162 Japan  
Phone: 81-3-3267-7891  
FAX: 81-3-3267-8510

## World Headquarters

#### Linear Technology Corporation

1630 McCarthy Blvd.  
Milpitas, CA 95035-7417  
Phone: (408) 432-1900  
FAX: (408) 434-0507