

# ISOLATED HERMETIC TO-257AA ADJUSTABLE VOLTAGE REGULATORS

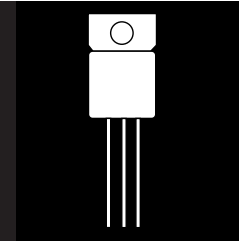

**Three Terminal, Adjustable Voltage, 3.0 Amp Precision Negative Regulators In Hermetic JEDEC TO-257AA Package**

### FEATURES

- Isolated Hermetic Package, JEDEC TO-257AA Outline
- Reference Voltage Set Internally to  $\pm 2\%$
- Built-In Thermal Overload Protection
- Short Circuit Current Limiting
- Pin Out Identical To Plastic TO-220
- Product Is Available Screened To MIL-STD-883

### DESCRIPTION

These three terminal negative regulators are supplied in a hermetically sealed metal package whose outline is similar to the industry standard TO-220 plastic package. All protective features are designed into the circuit, including thermal shutdown, current limiting and safe-area control. With heat sinking, they can deliver over 3.0 amps of output current. These units feature 2% initial voltage tolerance, with 1.0% load regulation and .015% line regulation.

### ABSOLUTE MAXIMUM RATINGS @ 25°C

Input Voltage .....	-35V
Operating Junction Temperature Range .....	-55°C to +150°C
Storage Temperature Range .....	-65° to +150°C
Typical Power/Thermal Characteristics:	
Rated Power @ 25°C	
$T_C$ .....	28W
$T_A$ .....	3W
Thermal Resistance	
$\theta_{JC}$ .....	4.2°C/W
$\theta_{JA}$ .....	42°C/W

3.3

**ELECTRICAL CHARACTERISTICS** -55°C  $T_A$  +125°C (unless otherwise specified)

Parameter	Symbol	Test Conditions	Min.	Max.	Unit
Reference Voltage	$V_{REF}$	$V_{IN} - V_{OUT} \approx 5\text{ V}, I_{OUT} = 5\text{ mA}, T_A = 25^\circ\text{C}$	-1.238	-1.262	V
		3 V $V_{IN} - V_{OUT} \approx 35\text{ V}$	• -1.215	-1.285	
Line Regulation (Note 1)	$\frac{\Delta V_{OUT}}{\Delta V_{IN}}$	3 V $V_{IN} - V_{OUT} \approx 35\text{ V}$		0.015	%V
			•	0.04	
Load Regulation (Note 1)	$\frac{\Delta V_{OUT}}{\Delta I_{OUT}}$	$V_{OUT} \approx 5\text{ V}, T_A = 25^\circ\text{C}$ 10 mA $I_{OUT} I_{MAX}$		50	mV
			•	75	
		$V_{OUT} \approx 5.0\text{ V}$ 10 mA $I_{OUT} I_{MAX}$		1.0	%
			•	1.5	
Thermal Regulation	-	30 ms pulse, $T_A = 25^\circ\text{C}$		0.02	%/W
Ripple Rejection (Note 2)	$\frac{\Delta V_{IN}}{\Delta V_{REF}}$	$V_{OUT} \approx -10\text{ V}, f = 120\text{ Hz}, C_{Adj} = 0$		56	dB
			•	53	
		$V_{OUT} \approx -10\text{ V}, f = 120\text{ Hz}, C_{Adj} = 10\text{ }\mu\text{F}$		70	dB
•	60				
Adjust Pin Current	$I_{Adj}$	$V_{DIFF} = 35\text{ V}, I_L = 10\text{ mA}$	•	100	$\mu\text{A}$
Adjust Pin Current Change	$\Delta I_{Adj}$	10 mA $I_{OUT} I_{MAX}$	•	2.0	$\mu\text{A}$
		3 V $V_{IN} - V_{OUT} \approx 35\text{ V}$	•	5.0	
Minimum Load Current	$I_{Min}$	$V_{IN} - V_{OUT} \approx 35\text{ V}$	•	5.0	mA
		$V_{IN} - V_{OUT} \approx 10\text{ V}$	•	3.0	
Current Limit	$I_{Lim}$	$V_{IN} - V_{OUT} \approx 10\text{ V}$		3.0	A
			•	3.0	
		$V_{IN} - V_{OUT} \approx 35\text{ V}$		0.5	A
			•	0.5	
Temperature Stability (Note 2)	$\frac{\Delta V_{OUT}}{\Delta T}$	-55°C $T_J$ +125°C	•	1.5	%
Long Term Stability (Note 2)	$\frac{\Delta V_{OUT}}{\Delta T}$	$T_A = +125^\circ\text{C}, t = 1000\text{ hrs}$		1.0	%

**Notes:**

- Line and Load Regulation are measured at a constant junction temperature using a low duty cycle pulse technique. Although power dissipation is internally limited, regulation is guaranteed up to the maximum power dissipation of 30 W. Power dissipation is determined by the input/output differential voltage and the output current. Guaranteed maximum power dissipation will not be available over the full input/output voltage range.
- Guaranteed by design, characterization or correlation to other tested parameters.
- The • denotes the specifications which apply over the full operating temperature range.

## TYPICAL PERFORMANCE CHARACTERISTICS

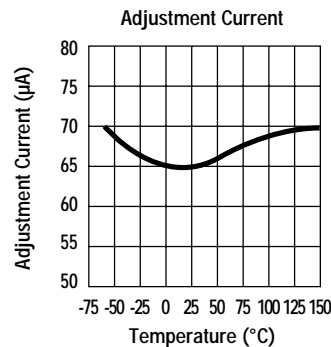
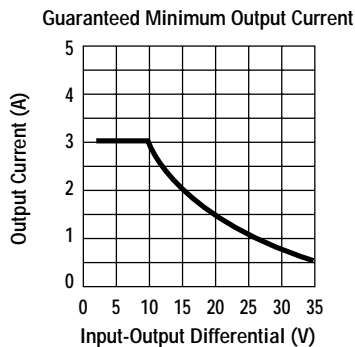
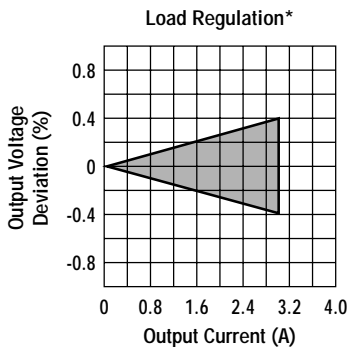
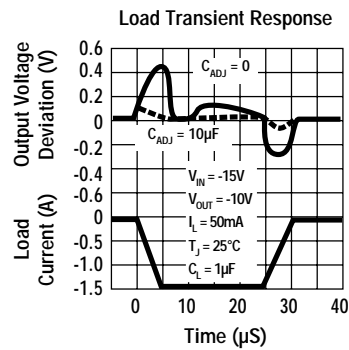
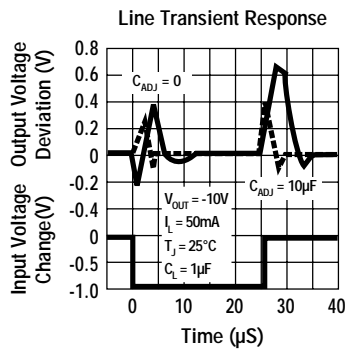
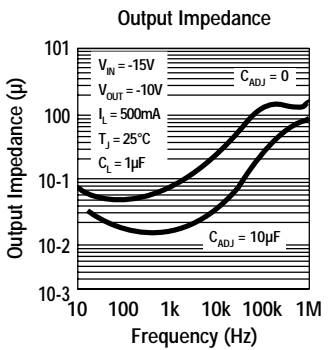
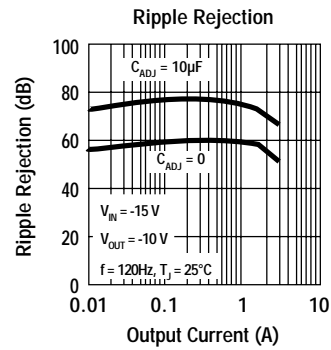
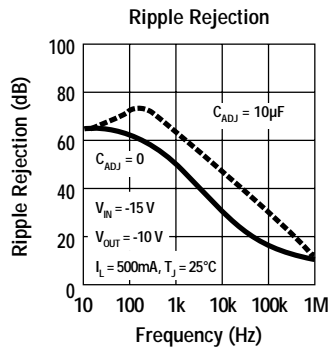
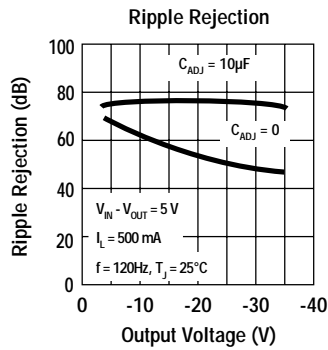
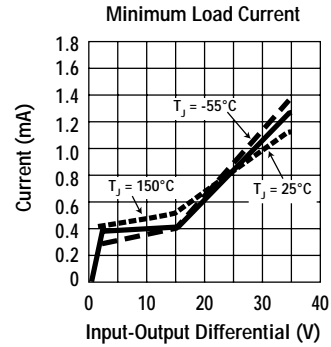
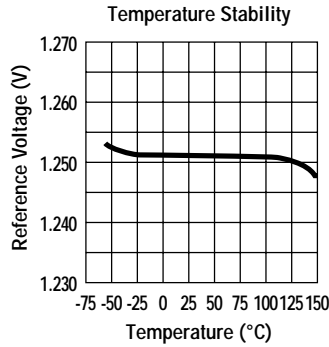
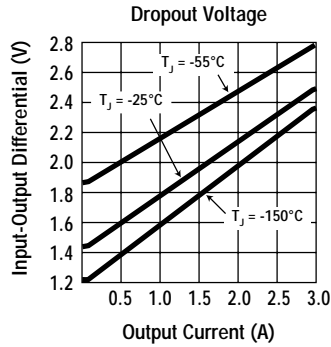

3.3

TYPICAL APPLICATIONS

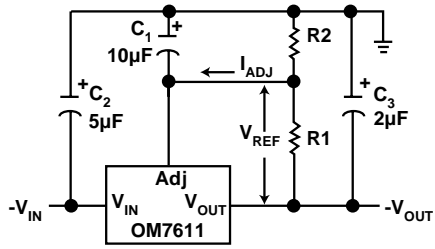

$$V_{OUT} = V_{REF} \left( 1 + \frac{R2}{R1} \right) + I_{ADJ} (R2)$$

High Stability Regulator

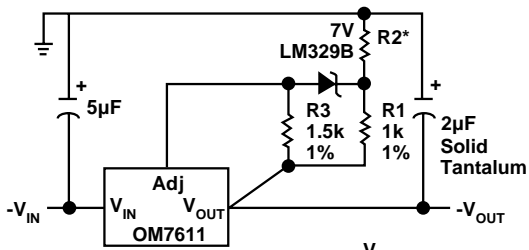

$$*R2 = \frac{V_{OUT}}{9.08 \times 10^{-3}} - 908\Omega$$

Multiple Tracking Regulators

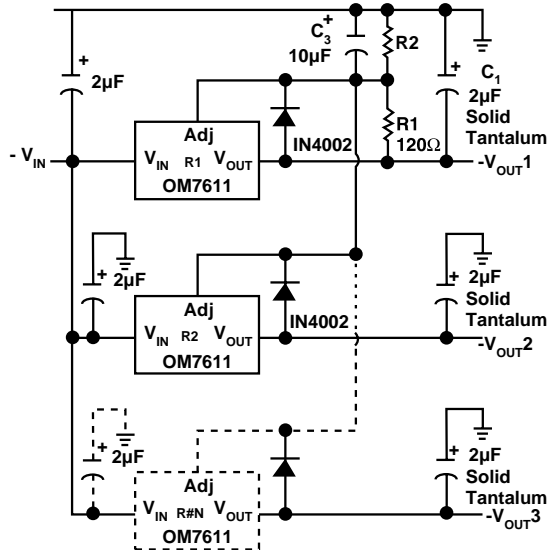

MECHANICAL OUTLINE

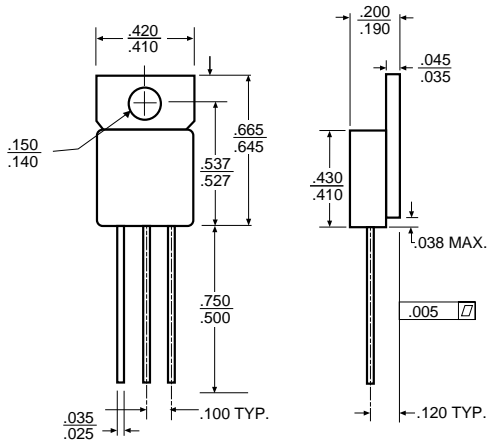

NOTES

- Case is metal/hermetically sealed
- Isolated Tab

PIN CONNECTION

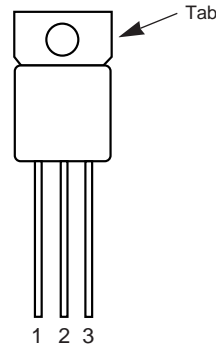

- Front View  
 Pin 1: Adjust  
 Pin 2: V<sub>IN</sub>  
 Pin 3: V<sub>OUT</sub>  
 Tab: Isolated