

MC3476

Low Cost Programmable Operational Amplifier

The MC3476 is a low cost selection of the popular industry standard MC1776 programmable operational amplifier. This extremely versatile operational amplifier features low power consumption and high input impedance. In addition, the quiescent currents within the device may be programmed by the choice of an external resistor value or current source applied to the I_{set} input. This allows the amplifier's characteristics to be optimized for input current and power consumption despite wide variations in operating power supply voltages.

- ± 6.0 V to ± 18 V Operation
- Wide Programming Range
- Offset Null Capability
- No Frequency Compensation Required
- Low Input Bias Currents
- Short Circuit Protection

LOW COST PROGRAMMABLE OPERATIONAL AMPLIFIER

SEMICONDUCTOR TECHNICAL DATA

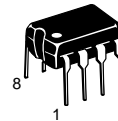

P1 SUFFIX
PLASTIC PACKAGE
CASE 626

Resistive Programming (See Figure 1)

R_{set} to Ground

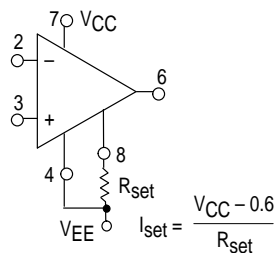

R_{set} to Negative Supply

(Recommended for supply voltage less than ± 6.0 V)

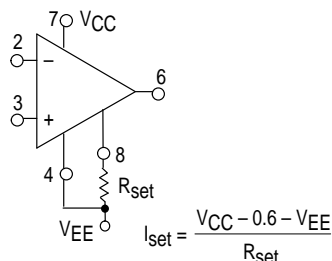

Typical R_{set} Values

V_{CC}, V_{EE}	$I_{set} = 1.5 \mu A$	$I_{set} = 15 \mu A$
± 6.0 V	3.6 M Ω	360 k Ω
± 10 V	6.2 M Ω	620 k Ω
± 12 V	7.5 M Ω	750 k Ω
± 15 V	10 M Ω	1.0 M Ω

Typical R_{set} Values

V_{CC}, V_{EE}	$I_{set} = 1.5 \mu A$	$I_{set} = 15 \mu A$
+1.5 V	1.6 M Ω	160 k Ω
+3.0 V	3.6 M Ω	360 k Ω
+6.0 V	7.5 M Ω	750 k Ω
+15 V	20 M Ω	2.0 M Ω

PIN CONNECTIONS

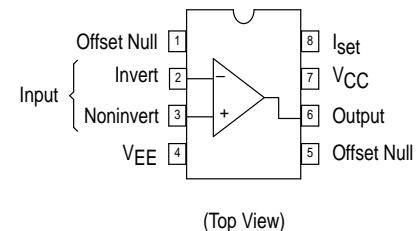

Active Programming

FET Current Source

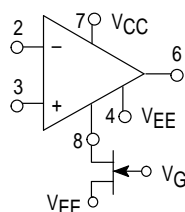

Bipolar Current Source

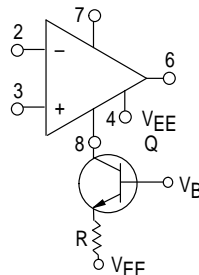

Pins not shown are not connected.

ORDERING INFORMATION

Device	Operating Temperature Range	Package
MC3476P1	$T_A = 0^\circ$ to $+70^\circ C$	Plastic DIP

MC3476

MAXIMUM RATINGS ($T_A = +25^\circ\text{C}$, unless otherwise noted.)

Rating	Symbol	Value	Unit
Power Supply Voltages	V_{CC}, V_{EE}	± 18	Vdc
Input Differential Voltage Range	V_{IDR}	± 30	Vdc
Input Common Mode Voltage Range	V_{ICR}	V_{CC}, V_{EE}	Vdc
Offset Null to V_{EE} Voltage	$V_{off} - V_{EE}$	± 0.5	Vdc
Programming Current	I_{set}	200	μA
Programming Voltage (Voltage from I_{set} Terminal to Ground)	V_{set}	$(V_{CC} - 0.6 \text{ V})$ to V_{CC}	Vdc
Output Short Circuit Duration (Note 1)	t_{SC}	Indefinite	sec
Operating Ambient Temperature Range	T_A	0 to $+70$	$^\circ\text{C}$
Storage Temperature Range	T_{stg}	-55 to $+125$	$^\circ\text{C}$
Junction Temperature	T_J	150	$^\circ\text{C}$

NOTES: 1. Short circuit to ground with $I_{set} \leq 15 \mu\text{A}$. Rating applies up to ambient temperature of $+70^\circ\text{C}$.

Representative Schematic Diagram

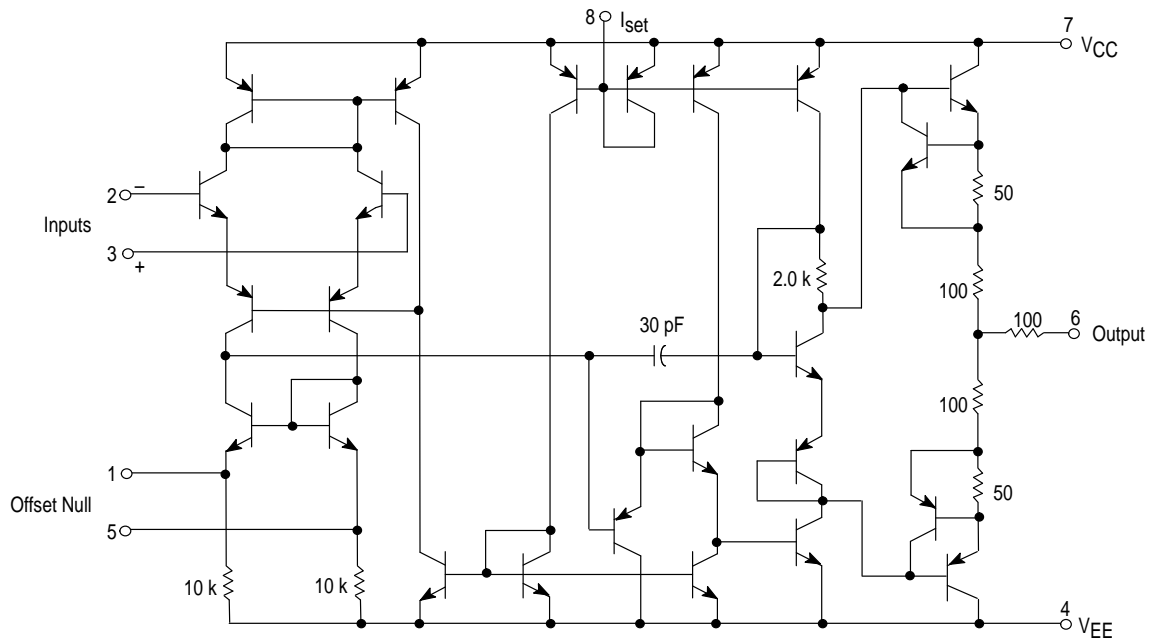

Voltage Offset Null Circuit

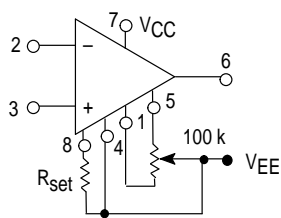

Transient Response Test Circuit

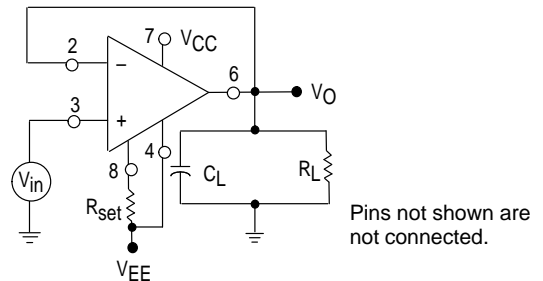

MC3476

ELECTRICAL CHARACTERISTICS ($V_{CC} = +15\text{ V}$, $V_{EE} = -15\text{ V}$, $I_{set} = 15\text{ }\mu\text{A}$, $T_A = +25^\circ\text{C}$, unless otherwise noted).

Characteristic	Symbol	Min	Typ	Max	Unit
Input Offset voltage ($R_S \leq 10\text{ k}\Omega$) $T_A = +25^\circ\text{C}$ $0^\circ\text{C} \leq T_A \leq +70^\circ\text{C}$	V_{IO}	– –	2.0 –	6.0 7.5	mV
Offset Voltage Adjustment Range	V_{IOR}	–	18	–	mV
Input Offset Current $T_A = +25^\circ\text{C}$ $T_A = +70^\circ\text{C}$ $T_A = 0^\circ\text{C}$	I_{IO}	– – –	20 – –	25 25 40	nA
Input Bias Current $T_A = +25^\circ\text{C}$ $T_A = +70^\circ\text{C}$ $T_A = 0^\circ\text{C}$	I_{IB}	– – –	15 – –	50 50 100	nA
Input Resistance	r_i	–	5.0	–	M Ω
Input Capacitance	C_i	–	2.0	–	pF
Input Common Mode Voltage Gain $0^\circ\text{C} \leq T_A \leq +70^\circ\text{C}$	V_{ICR}	± 10	–	–	V
Large Signal Voltage Gain $R_L \geq 10\text{ k}\Omega$, $V_O = \pm 10\text{ V}$, $T_A = +25^\circ\text{C}$ $R_L \geq 10\text{ k}\Omega$, $V_O = \pm 10\text{ V}$, $0^\circ\text{C} \leq T_A \leq +70^\circ\text{C}$	A_{VOL}	50 k 25 k	400 k –	– –	V/V
Output Voltage Range $R_L \geq 10\text{ k}\Omega$, $T_A = +25^\circ\text{C}$ $R_L \geq 10\text{ k}\Omega$, $0^\circ\text{C} \leq T_A \leq +70^\circ\text{C}$	V_{OR}	± 12 ± 12	± 13 –	– –	V
Output Resistance	r_o	–	1.0	–	k Ω
Output Short Circuit Current	I_{SC}	–	12	–	mA
Common Mode Rejection $R_S \leq 10\text{ k}\Omega$, $0^\circ\text{C} \leq T_A \leq +70^\circ\text{C}$	CMR	70	90	–	dB
Supply Voltage Rejection Ratio $R_S \leq 10\text{ k}\Omega$, $0^\circ\text{C} \leq T_A \leq +70^\circ\text{C}$	PSRR	–	25	200	$\mu\text{V/V}$
Supply Current $T_A = +25^\circ\text{C}$ $0^\circ\text{C} \leq T_A \leq +70^\circ\text{C}$	I_{CC} , I_{EE}	– –	160 –	200 225	μA
Power Dissipation $T_A = +25^\circ\text{C}$ $0^\circ\text{C} \leq T_A \leq +70^\circ\text{C}$	P_D	– –	4.8 –	6.0 6.75	mW
Transient Response (Unity Gain) $V_{in} = 20\text{ mV}$, $R_L \geq 10\text{ k}\Omega$, $C_L = 100\text{ pF}$ Rise Time Overshoot	t_{TLH} t_{os}	– –	0.35 10	– –	μs %
Slew Rate ($R_L \geq 10\text{ k}\Omega$)	SR	–	0.8	–	V/ μs

Figure 1. Set Current versus Set Resistor

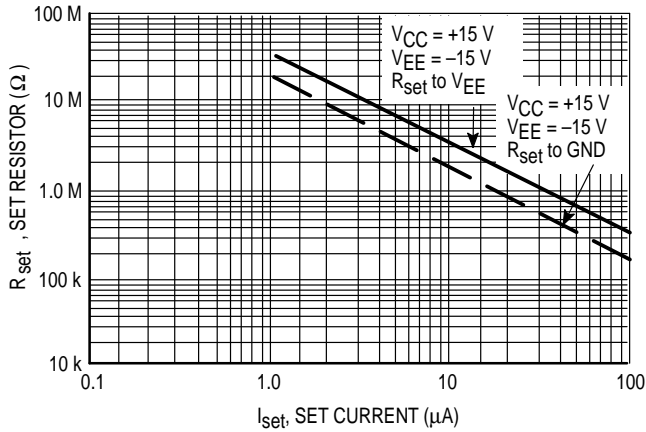

Figure 2. Positive Standby Supply Current versus Set Current

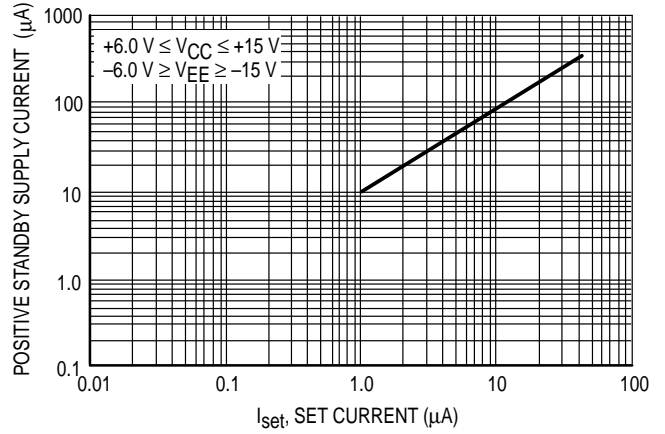

Figure 3. Open Loop versus Set Current

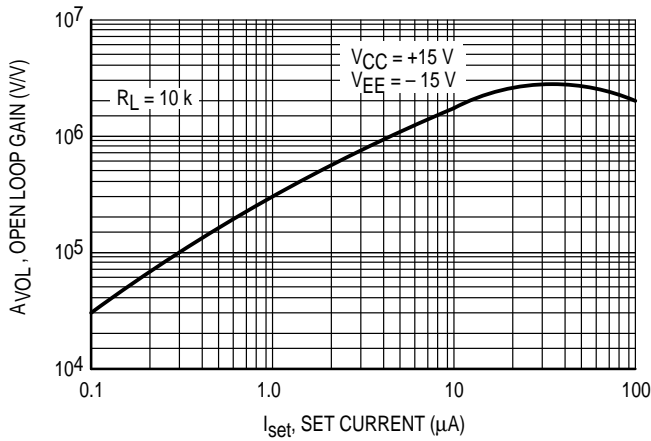

Figure 4. Input Bias Current versus Set Current

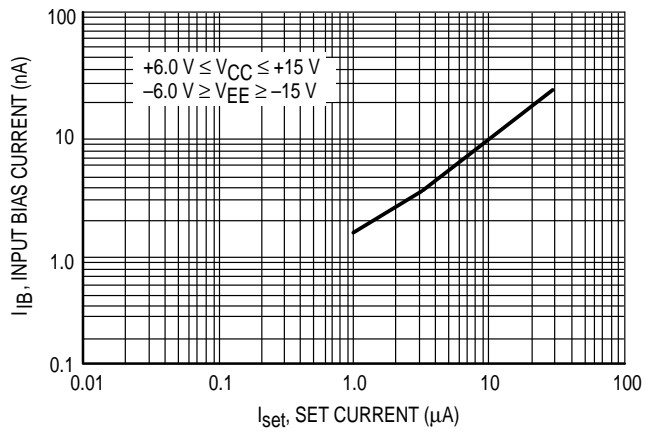

Figure 5. Slew Rate versus Set Current

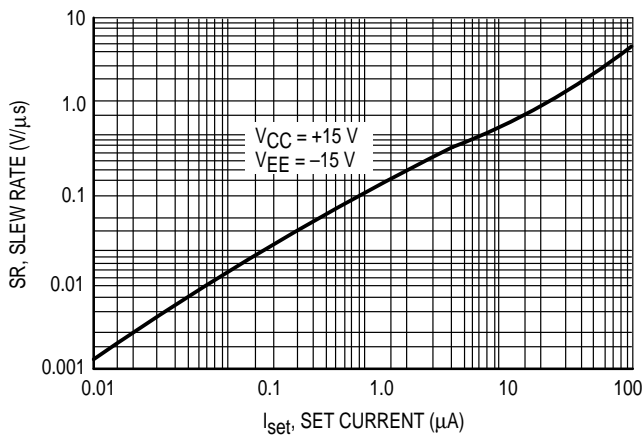

Figure 6. Gain Bandwidth Product versus Set Current

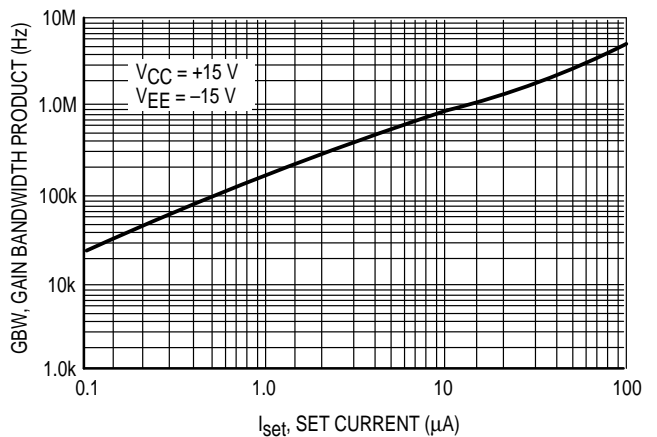

Figure 7. Output Voltage Swing versus Load Resistance

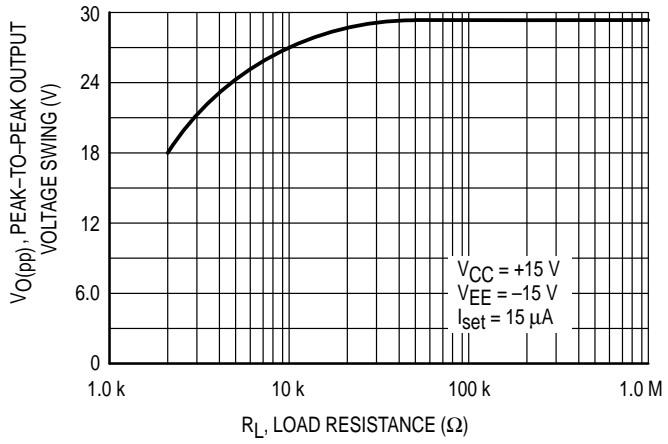
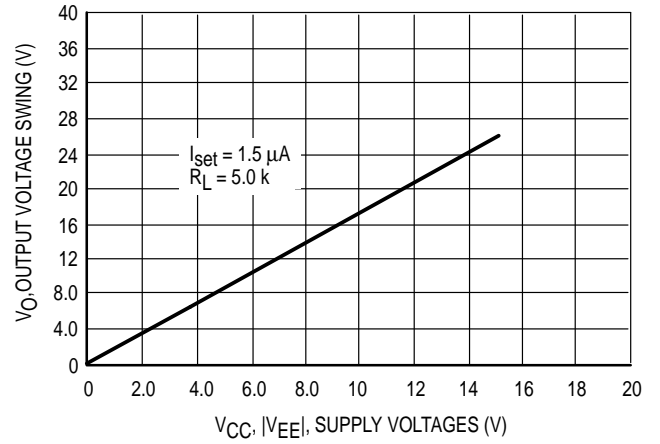

Figure 8. Output Voltage Swing versus Supply Voltage



MC3476

OUTLINE DIMENSIONS

P1 SUFFIX
PLASTIC PACKAGE
CASE 626-05
ISSUE K

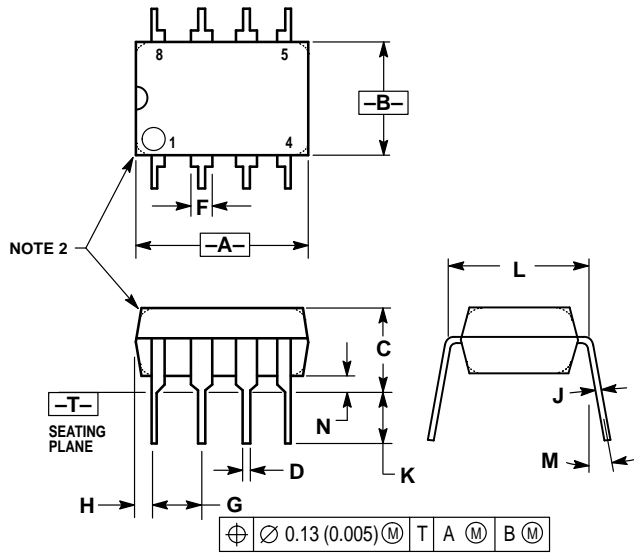

NOTES:

1. DIMENSION L TO CENTER OF LEAD WHEN FORMED PARALLEL.
2. PACKAGE CONTOUR OPTIONAL (ROUND OR SQUARE CORNERS).
3. DIMENSIONING AND TOLERANCING PER ANSI Y14.5M, 1982.

DIM	MILLIMETERS		INCHES	
	MIN	MAX	MIN	MAX
A	9.40	10.16	0.370	0.400
B	6.10	6.60	0.240	0.260
C	3.94	4.45	0.155	0.175
D	0.38	0.51	0.015	0.020
F	1.02	1.78	0.040	0.070
G	2.54 BSC		0.100 BSC	
H	0.76	1.27	0.030	0.050
J	0.20	0.30	0.008	0.012
K	2.92	3.43	0.115	0.135
L	7.62 BSC		0.300 BSC	
M	—		10°	
N	0.76	1.01	0.030	0.040

Motorola reserves the right to make changes without further notice to any products herein. Motorola makes no warranty, representation or guarantee regarding the suitability of its products for any particular purpose, nor does Motorola assume any liability arising out of the application or use of any product or circuit, and specifically disclaims any and all liability, including without limitation consequential or incidental damages. "Typical" parameters which may be provided in Motorola data sheets and/or specifications can and do vary in different applications and actual performance may vary over time. All operating parameters, including "Typicals" must be validated for each customer application by customer's technical experts. Motorola does not convey any license under its patent rights nor the rights of others. Motorola products are not designed, intended, or authorized for use as components in systems intended for surgical implant into the body, or other applications intended to support or sustain life, or for any other application in which the failure of the Motorola product could create a situation where personal injury or death may occur. Should Buyer purchase or use Motorola products for any such unintended or unauthorized application, Buyer shall indemnify and hold Motorola and its officers, employees, subsidiaries, affiliates, and distributors harmless against all claims, costs, damages, and expenses, and reasonable attorney fees arising out of, directly or indirectly, any claim of personal injury or death associated with such unintended or unauthorized use, even if such claim alleges that Motorola was negligent regarding the design or manufacture of the part. Motorola and  are registered trademarks of Motorola, Inc. Motorola, Inc. is an Equal Opportunity/Affirmative Action Employer.

MC3476

How to reach us:

USA/EUROPE/Locations Not Listed: Motorola Literature Distribution;
P.O. Box 20912; Phoenix, Arizona 85036. 1-800-441-2447 or 602-303-5454

MFAX: RMFAX0@email.sps.mot.com – TOUCHTONE 602-244-6609
INTERNET: <http://Design-NET.com>

JAPAN: Nippon Motorola Ltd.; Tatsumi-SPD-JLDC, 6F Seibu-Butsuryu-Center,
3-14-2 Tatsumi Koto-Ku, Tokyo 135, Japan. 03-81-3521-8315

ASIA/PACIFIC: Motorola Semiconductors H.K. Ltd.; 8B Tai Ping Industrial Park,
51 Ting Kok Road, Tai Po, N.T., Hong Kong. 852-26629298



MOTOROLA



MC3476/D

