

SANYO

No. 3808

LC83010

CMOS LSI

AUDIO DIGITAL SIGNAL PROCESSOR

1. Overview

The LC83010 is a single-chip digital signal processor (DSP). It is designed for use in the application fields such as a digital processing of audio signals.

The LC83010 CMOS processor has various on-chip filtering circuits such as a graphic equalizer for reproduction of sound quality. It also has simulation circuit for reverberation (sound reflection and echo), so that sound field with surround and delay can be created.

2. Features

- LSI functions

- 1) Dual Harvard Architecture: Enables simultaneous processing (multiply and addition) of stereo signals in a single instruction cycle.

The LC83010 processor has the following two independent units:

- Multiplier : 24 bits x 16 bits (fixed-point decimal)
- ALU : 32-bit arithmetic calculation, 24-bit arithmetic and logical operations
- ACCumulator (ACC) : 32 bits
- Temporal Registers (TMP0 to TMP7) : 32-bit for each
- Internal Memory

Data RAM	128 x 24 bits
Coefficient RAM	256 x 16 bits
Constant ROM	256 x 24 bits

- 2) Program Memory Capacity (RAM) : 320 x 32 bits

- 3) A variety of I/O interfaces

- Audio signal I/O
 - 1 channel for input (applicable to various formats)
 - 3 channels for output (applicable to up to 4 types of data format)
- Surround DRAM access signal
 - 16 accesses/CH Max. (within 1 fs)
 - Up to 2 256K (64K x 4 bits) DRAMs or 1M (256K x 4 bits) DRAMs can be directly connected to this chip.
- Serial Input/Output interface with a microcomputer
 - Synchronous 8-bit serial input : 1
 - [Mail box (16 bits x 8) function available]
 - Synchronous 8-bit serial output : 1

- 4) Interrupt function (Vectored interrupt with the INT pin)

- 5) Stack Nesting Levels : 4

- 6) On-chip Interval/Timer : 12 bits (timer clock = sampling frequency)

- 7) Cycle time : 108ns (sampling frequency = 48kHz)

- 8) Single 5V power supply

- 9) Package : DIP-64S

- 10) Evaluation chip : LC83EV010 (PGA100)

- Applications
- Graphic Equalizer
- Power calculation for spectrum analyzer display
- Sound field creation (using external DRAMs)
- 4 Speakers + REC output

3. Development Environment

- Software Tools

- 1) Assembler
- 2) Debugger with simulation

- Hardware Tools

- 1) IBM PC-AT compatible machines or AX personal computers
- 2) In Circuit Emulator (ICE)

Specifications and information herein are subject to change without notice.

SANYO Electric Co., Ltd. Semiconductor Overseas Marketing Div.

1-3-1, Honcho, Bldg. 2, Chuo-ku, Shinjyuku-ku, TOKYO 163, JAPAN

LC83010

4. Pinout and Block Diagram

Block Diagram

P0	1	64	SRDY
P1	2	63	SIAR
P2	3	62	SIRQ
P3	4	61	SICK
P4	5	60	SI
P6	6	59	SOAK
AOTDF1	7	58	SORQ
AOTDF2	8	57	SOCK
DFBCK	9	56	SO
DFWCK	10	55	AOWCK
HAS	11	54	ASO
CAS	12	53	AORCK
DREAD	13	52	TEST4
DWRT	14	51	TEST3
V _{DD1}	15	50	TEST2
OSC1	16	49	TEST1
OSC2	17	48	V _{SS2}
V _{SS1}	18	47	INT
FS3840	19	46	RES
D0	20	45	V _{DD2}
D1	21	44	TEST5
D2	22	43	SELC
D3	23	42	LRCK1
D4	24	41	LRCK0
D5	25	40	AS12
D6	26	39	AS11
D7	27	38	BCK2
A0	28	37	BCK1
A1	29	36	A8
A2	30	35	A7
A3	31	34	A6
A4	32	33	A5

LC83010

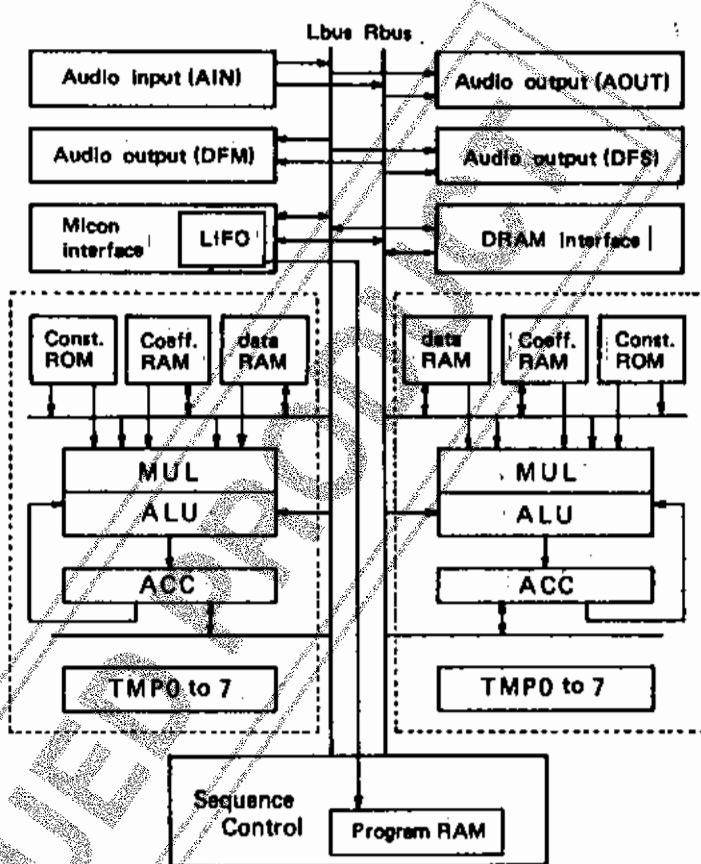

Case Outline 3071-D641C
(units: mm)

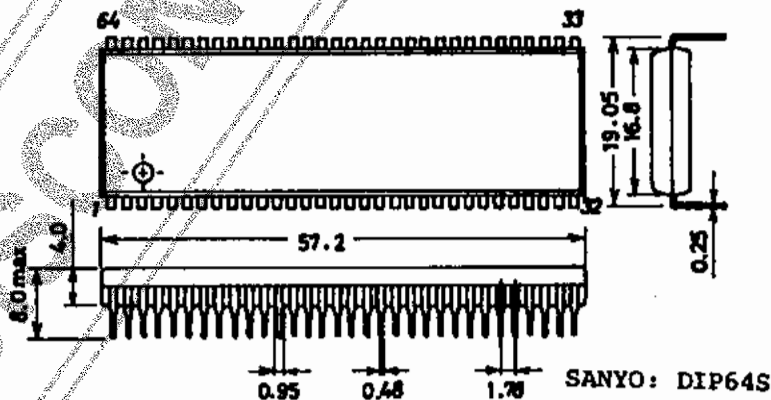



LC83010

5. Pin Description

Pin Name	I/O	Pin No.	Functional Description	
VDD1,2	I	15,45	+5V power supply pins (These pins should be connected to the positive power source.)	
VSS1,2	I	18,48	GND power supply pins (These pins should be connected to the ground level.)	
Audio I/F (Interface)	ASI1	I	39	Audio data serial input 1
	ASI2	I	40	Audio data serial input 2
	ACK1	I	37	Bit clock input pin for ASI1 data
	BCK2	I/O	38	Bit clock input pin for ASI2 data (I/O selectable by CR)
	LRCKI	I	42	Input pin for L/R channel distinguish signal (H: L channel data ; L: R channel data)
	LRCKO	O	41	Input pin for L/R channel distinguish signal (H: L channel data ; L: R channel data)
	ASO	O	54	Audio data serial output
	AOBCK	O	53	Bit clock output pin for ASO data (for 32fs and 48fs)
	AOWCK	O	55	Word clock output pin for ASO data
	AOTDF1	O	7	Serial output pin for audio data (for high presence 1)
	AOTDF2	O	8	Serial output pin for audio data (for high presence 2)
DFBCK	O	9	Bit clock output pin for AOTDF1 and AOTDF2 data (for 32fs and 48fs)	
DFWCK	O	10	Word clock output pin for AOTDF1 and AOTDF2 data	
DRAM I/F	RAS	O	11	Output pin for RAS signal to external DRAMs
	CAS	O	12	Output pin for CAS signal to external DRAMs
	BREAD	O	13	Output pin for data read signal to external DRAMs
	BWRT	O	14	Output pin for data write signal to external DRAMs
	A0 to 8	O	28 to 36	Output pins for address signals to external DRAMs (64K x 4 bits: A0 to A7, 256K x 4 bits: A0 to A8)
	D0 to 7	I/O	20 to 27	Input/output pins for data transfer with external DRAMs. In the single DRAM configuration mode, pins D0 to D3 are used. In the double DRAM configuration mode, pins D0 to D7 are used.
Microcomputer I/F	SI	I	60	Input pin for serial data from control microcomputer (8-bit serial data)
	SICK	I	61	Serial clock input pin for SI data
	SIRQ	I	62	Request signal input pin for serial data input
	SIACK	O	63	Output pin for Acknowledge response to the input request signal from a microcomputer
	SRDY	I	64	Input pin for a Ready signal from a controlling microcomputer indicating the end of a data transfer
	SO	O	56	Output pin for serial data to a controlling microcomputer (8-bit serial data)
	SOCK	I	57	Serial clock input pin for SO data
	SORQ	I	58	Request signal input pin for serial data output
SOACK	O	59	Output pin for Acknowledge response to the output request signal from a microcomputer	
P0 to 5	I/O	1 to 6	General-purpose Input/Output ports (with on-chip pull-up resistor)	
OSC	OSC1	I	16	Pin for connection with a crystal oscillator or for clock input from an external source. (384fs)
	OSC2	O	17	Pin for connection with a crystal oscillator (should be left open in external clock input mode)
Control pins	FS3840	O	19	384fs output pin
	INT	I	47	Interrupt request input pin (with on-chip pull-up resistor)
	RES	I	46	Reset input pin (with on-chip pull-up resistor)
	SELC	I	43	L/R channel signal select input pin with on-chip pull-down resistor; L: external (LRCKI), H: internal (internal divider output)
	TEST 1 to 4	I	49 to 52	Test signal input pins. Normally, these pins should be connected to the ground level.
TEST5	O	44	Test signal output pins. Normally, these pins should be left open.	

LC83010

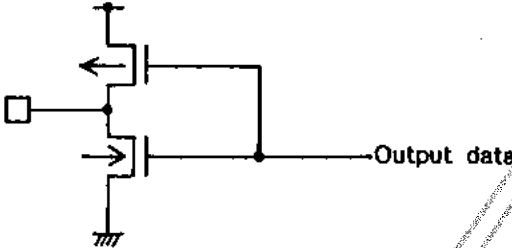
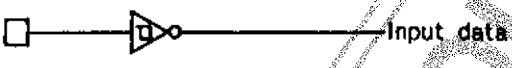
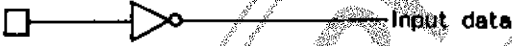
Pin configuration types

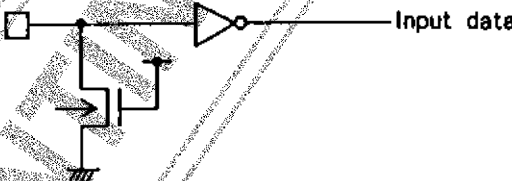
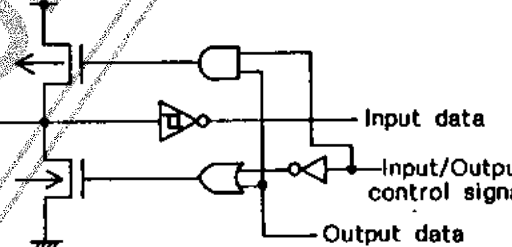
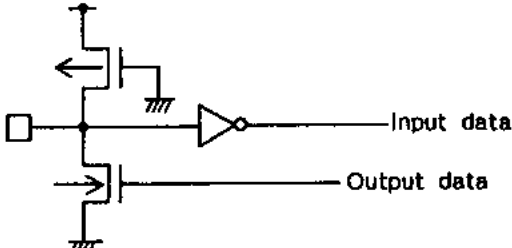
Level specification	Circuit type	Pin Name
TTL level output		AS0,AOWCK,LRCKO, AOTDF1,AOTDF2, DFWCK,A0 to A8, FS3840,RAS,CAS, DREAD,DWRT
CMOS medium level current output		SO,SOCAK,SIK
Schmitt Input		SOCK,SI,SICK,SORQ, SIRQ,SRDY
L level Schmitt Input		BCK,ASI1,ASI2,LRCKI
Normal Input		TEST1 to 4
Input with internal pull-up resistor		RES,INT
Input with internal pull-down resistor		SEL0
TTL level output Low level Schmitt input		BCK2,D0 to D7
Pu MOS medium current output Normal Input		P0 to P5

LC83010

6. Electrical Specifications

Maximum Absolute Ratings/ $T_a=25^{\circ}\text{C}$, $V_{SS}=0\text{V}$

Parameter	Symbol	Pins	Condition	Standard Values	unit	Note
Maximum Supply Voltage	V_{DDmax}			-0.3 to +0.7	V	
Output Voltage	V01	OSC2 output		Up to the voltage produced by oscillation	V	
	V02	Pins except for the OSC2		-0.3 to $V_{DD}+0.3$	V	
Input Voltage	V_{IN}			-0.3 to $V_{DD}+0.3$	V	
Peak Output Current	IOP1	Audio I/F DRAM I/F		-2 to +4	mA	1
	IOP2	Microcomputer I/F		-2 to +10	mA	2
	IOP3	P0 to 5		-0.5 to +10	mA	3
Average Output Current	IOA1	Audio I/F	Per pin	-2 to +4	mA	4
	IOA2	Audio I/F DRAM I/F	Per pin	-2 to +4	mA	5
	IOA3	Microcomputer I/F	Per pin	-2 to +10	mA	2
	IOA4	P0 to 5	Per pin	-0.5 to +10	mA	3
	$\Sigma IOA1$	Audio I/F	Total	-11 to +45	mA	4
	$\Sigma IOA2$	Audio I/F DRAM I/F	Total	-4 to +15	mA	5
	$\Sigma IOA3$	Microcomputer I/F	Total	4 to +15	mA	2
	$\Sigma IOA4$	P0 to 5	Total	-3 to +30	mA	3
Allowable Power Dissipation	$P_{d,max}$		$T_a=-30$ to $+70^{\circ}\text{C}$	600	mW	
Operating Ambient Temperature Range	T_{opg}			-30 to +70	$^{\circ}\text{C}$	
Storage temperature range	T_{stg}			-40 to +125	$^{\circ}\text{C}$	

LC83010

Allowable Operating Conditions (Ta=-30°C to +70°C, VDD=4.75V to 5.25V, VSS=0V, unless otherwise noted)

Parameter	Symbol	Pins and Conditions	Standard values			unit	Note
			min	typ	max		
Operating Supply Voltage	VDD		4.75		5.25	V	
High Level Input Voltage	VIH1	Audio I/F, DRAM I/F	2.4			V	6
	VIH2	P0 to P5, $\overline{\text{SEL}}\overline{\text{C}}$, TEST1 to 4	0.7VDD			V	
	VIH3	$\overline{\text{RES}}$, $\overline{\text{INT}}$, Microcomputer I/F	0.75VDD			V	7
Low Level Input Voltage	VIL1	Audio I/F, DRAM I/F			0.8	V	6
	VIL2	P0 to P5, $\overline{\text{SEL}}\overline{\text{C}}$, TEST1 to 4			0.3VDD	V	
	VIL3	$\overline{\text{RES}}$, $\overline{\text{INT}}$, Microcomputer I/F			0.25VDD	V	7
Operating Frequency (Instruction Cycle Time)	fOP (TCYC)	Up to 1% crystal oscillation error is allowed. max:48kHzX384X1.01	12.17 (165)		18.82 (107)ns	MHz (ns)	
External Clock Input Conditions	Frequency	fEXT	Applies to the OSC1 pin. See Figure 1. (OSC1 : input, OSC2: Open)		12.17	18.82	MHz
	Pulse width	tEXTH tEXTL			20		ns
	Rise Time Fall Time	tEXTR tEXTF				10	ns
Self-oscillation Conditions	Oscillation Frequency	fEXT	OSC1, OSC2 See Figure 2.			18.82	MHz
	Oscillation Stabilizing Period	fEXTS	See Figure 3.				ms
Audio Data Input Conditions	Transfer Bit Clock Cycle	tBOYC	Applies to the BCK1 and BCK2 pins. See Figure 4.		325		ns
	Transfer Bit Clock Pulse Width	tBCW			100		ns
	Date Set up Time	tS			75		ns
	Data Hold Time	tH			75		ns

Continued on the next page.

LC83010

Continued from the preceding page.

Parameter	Symbol	Pins and Conditions	Standard Values			unit	Note
			min	typ	max		
Serial I/O Clock Conditions	Serial Clock Cycle	tSCYC	Applies to the microcomputer interface. See Figure 5. (Applies to the SICK, SOCK and SI pins.)	650		ns	
	Serial Clock Pulse Width	tSCW		325		ns	
	Data set up Time	tSS		75		ns	
	Data Hold Time	tSH		75		ns	
DRAM Input Conditions	Date Set up Time	tDS	Applies to the data input from external DRAM. See Figure 6. (Timings between $\overline{\text{RAS}}$, $\overline{\text{CAS}}$ and D0 to D7)	50		ns	
	Data Hold Time	tDH		0		ns	

DISCONTINUED PRODUCT

LC83010

Electrical Characteristics (Ta=-30°C to +70 °C. VDD=4.75V to 5.25V. VSS=0V, unless otherwise noted)

Parameter	Symbol	Pins and Conditions	Standard Values			unit	Note
			min	typ	max		
Low Level Input Current	I _{IL}	RES,INT,P0 to P5 VIN=VSS Input pin with pull-up resistor	-250			μA	
High Level Input Current	I _{IH}	SEL _C ,input pin with pull-down resistor			250	μA	
High Level Output Voltage	VOH1	I _{OH} =-0.4mA	4.0			V	1
	VOH2	I _{OH} =-50μA	VDD-1.2			V	2,3
Low Level Output Voltage	VOL1	I _{OL} =2mA			0.4	V	1
	VOL2	I _{OL} =10mA			1.5	V	2,3
Input Leakage Current		VIN=VSS to VDD	-10		10	μA	
Output-off Leakage Current	I _{OFF}	VO=VSS,VDD	-40		40	μA	
Input/Output Capacitance					10	pF	
Audio Data Output Timing	Output Data Hold Time	t _{OH}	20			ns	
	Output Data Delay	t _{OD}			100	ns	
Microcomputer I/F Output Delay	Output Data Delay	t _{SD}			100	ns	

Continued on the next page.

DISCONTINUED PRODUCT

LC83010

Continued from the preceding page.

Parameter	Symbol	Pins and Conditions	Standard Values			unit	Notes
			min	typ	max		
Access Timings for External DRAM	RAS "H" Pulse Width	tRP	95			ns	
	RAS "L" Pulse Width	tRAS	150			ns	
	CAS "H" Pulse Width	tCP	80			ns	
	CAS "L" Pulse Width	tCAS	80			ns	
	RAS Address Set up Time	tRS	0			ns	
	RAS Address Hold Time	tRH	20			ns	
	CAS Address Set up Time	tCS	0			ns	
	CAS Address Hold Time	tCH	40			ns	
	DWRT Pulse Width	tW	50			ns	
	CAS-before-WRITE Set up Time	tWC	0			ns	
	Data Set up Time	tSD	0			ns	
	Data Hold Time	tHD	50			ns	
Crystal Oscillation	C1,C2	OSC1,OSC2 See Figure 2.		20		pF	
Current Dissipation	IDD	VDD1,2 18.62MHz external clock		50	100	mA	

(Note 1) TTL level output pins: AS0, AOWCK, LRCK0, BCK2, AOTDF1, AOTDF2, DFACK, DFWCK, D0 to D7, A0 to A8, FS3840, RAS, CAS, DREAD and DWRT

(Note 2) CMOS medium current outputs: SO, SOAK and SIAK

(Note 3) Pu MOS medium current outputs: P0 to P5

(Note 4) TTL level outputs (first group): AS0, AOWCK, LRCK0, A0 to A8, D0 to D7, FS3840 and BCK2

(Note 5) TTL level outputs (second group): AOTDF1, AOTDF2, DFWCK, RAS, CAS, DREAD, DWRT and DFACK

(Note 6) L level Schmitt input pins: BCK1, BCK2, ASI1, ASI2, LRCK1 and D0 to D7

(Note 7) Schmitt input pins: RES, INT, SOCK, SI, SICK, SORQ, SIRQ and SRDY

Figure 1. External input clock waveform (OSC1)

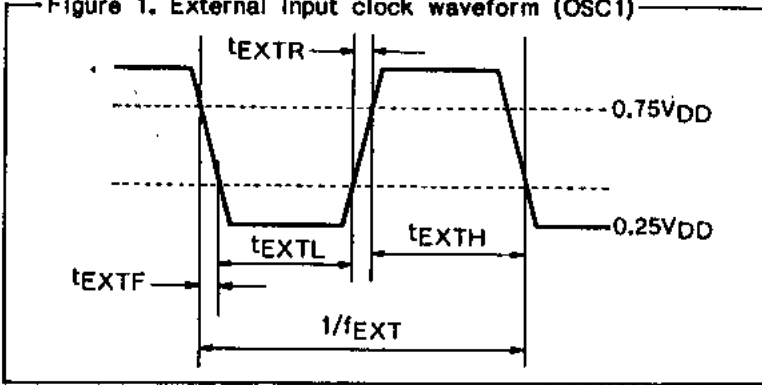

Figure 2. Crystal oscillation circuit

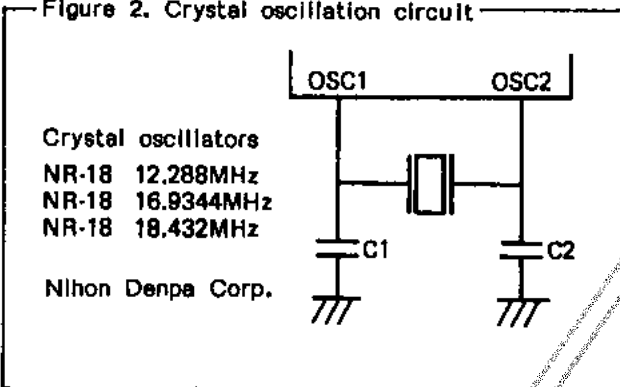

Figure 3. Oscillation stabilizing period

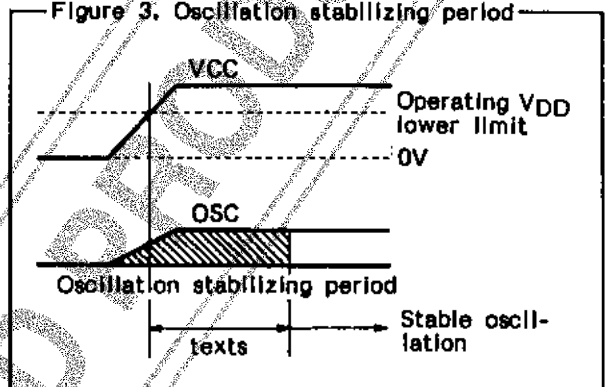

Figure 4. Audio data input conditions

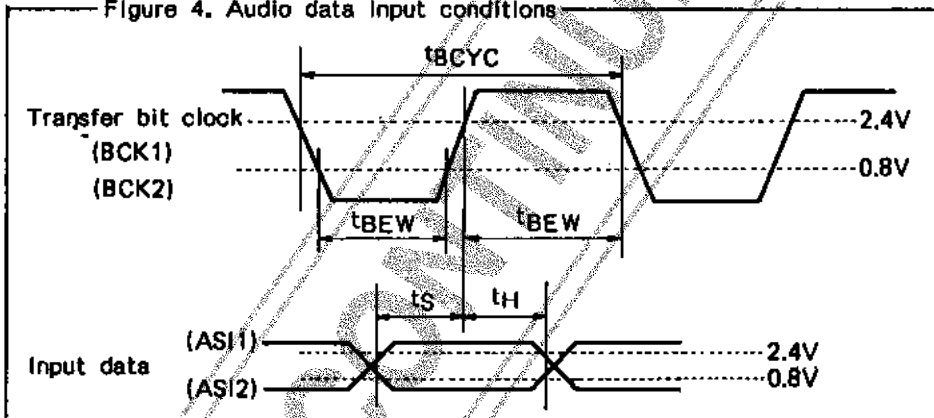

Figure 5. Microcomputer interface

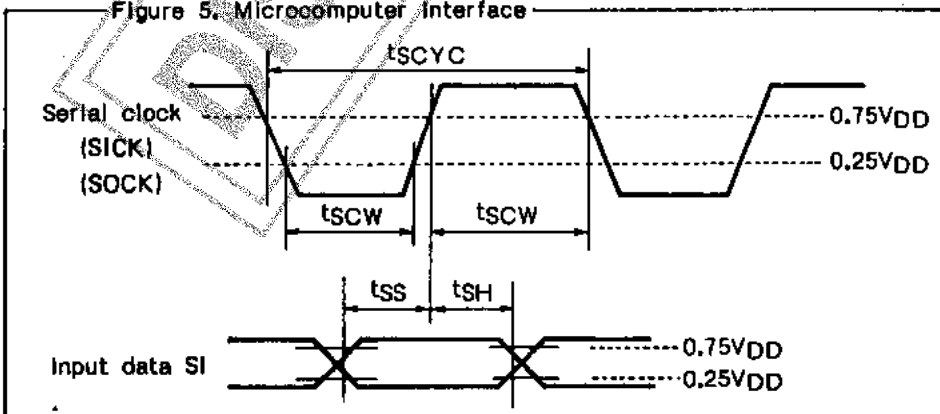

Figure 6. External DRAM data input condition ($DREAD = L$)

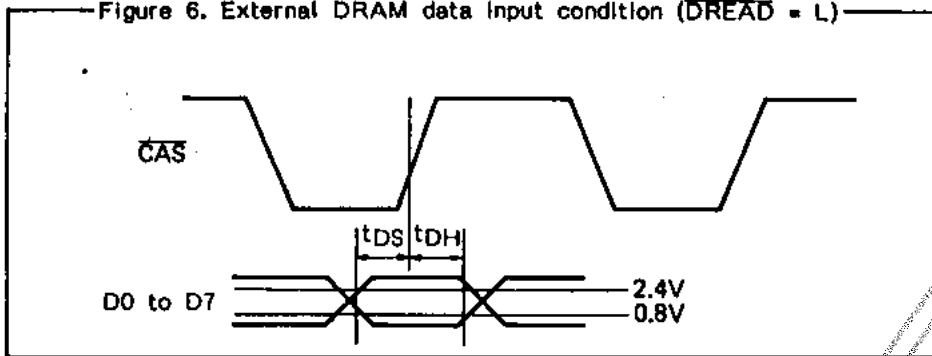

Figure 7. Audio data output timing

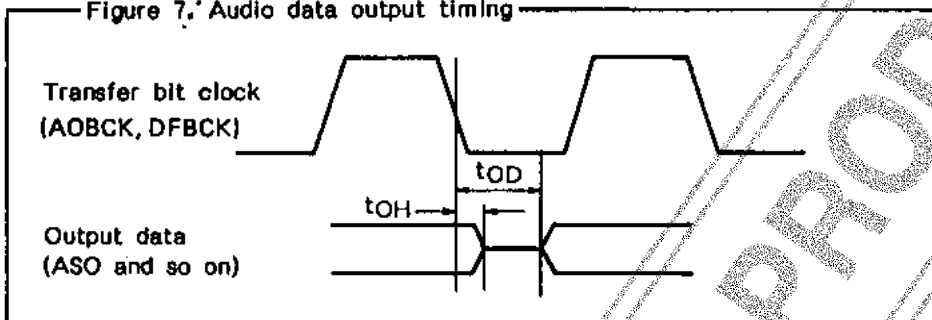

Figure 8. Microcomputer Interface serial output timing

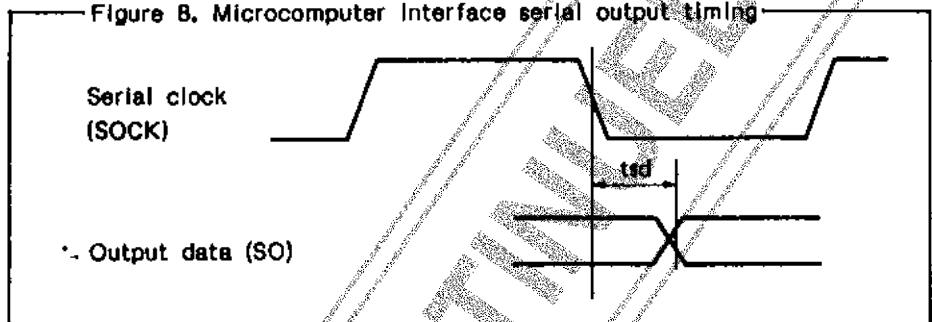
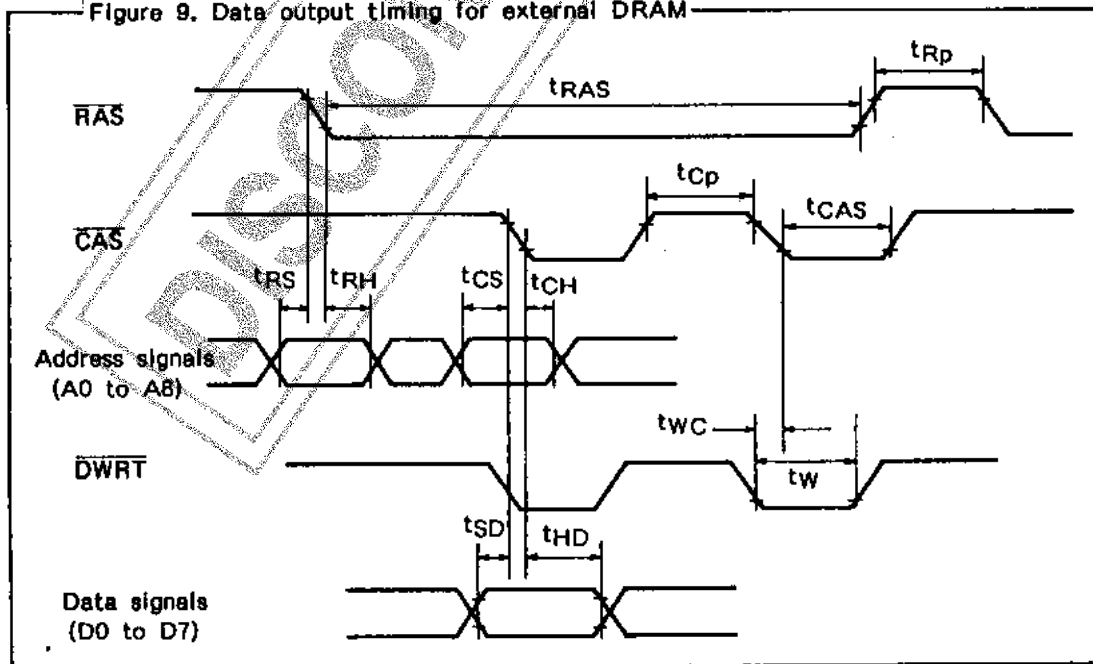

Figure 9. Data output timing for external DRAM



7. Program load to the LC83010
 - Boot procedure -

Programs must be loaded (boot strap) into the LC83010 (D²SP) from an external control unit (microcomputer) because its internal program memory consists of RAMs. The capacity of the program memory is 320 words x 32 bits.

The procedural flow to load a 320-word program into the LC83010 from a controlling microcomputer is shown in Figure A-1.

- (1) Reset the entire system (microcomputer and LC83010) or reset the D²SP from the controlling microcomputer. After the D²SP is reset, it then enters the Boot mode.
 - (2) Transfer the program to the D²SP from the microcomputer. The program is transferred to the D²SP in 8-bit synchronous serial communication mode. The program data of 8 bits x 16 data (equal to 4 instructions) is transferred to the LC83010 continuously from the microcomputer, and followed by the SRDY signal. The LC83010 stores that program data of 4 instructions to the internal mail box. The program data is then moved to the program RAM at the moment when the SRDY signal reaches the LC83010.
 - (3) The operations discussed in (2) are repeated 80 times until the program data transfer of 320 instructions from the microcomputer to the D²SP is complete.
 - (4) The LC83010 automatically starts the program execution when the program loading of 320 instructions is complete.
- The program is transferred to the D²SP from the microcomputer in that manner.

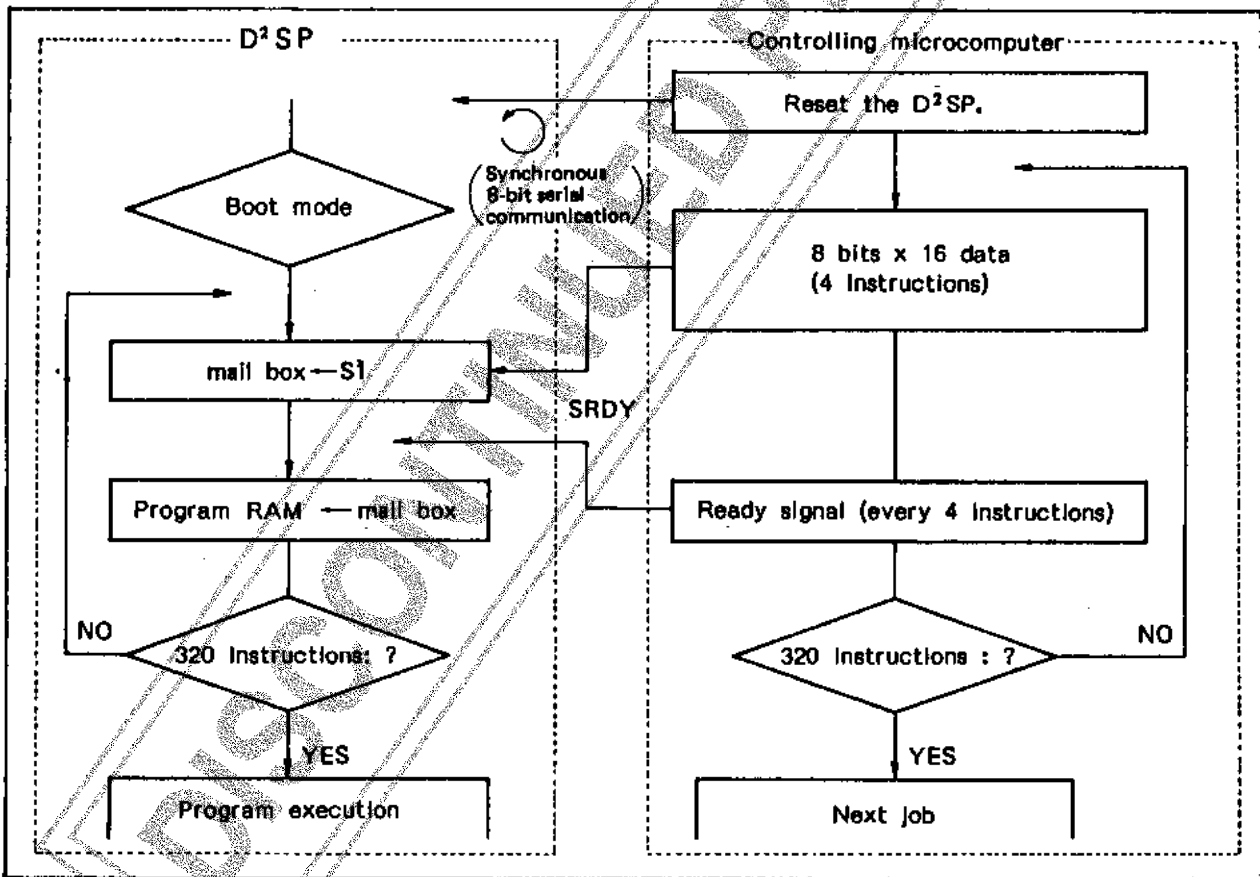

Figure A-1. Example Program Boot flow (D²SP ← Microcomputer)

Figure A-2 gives the outline of an example program Boot system.

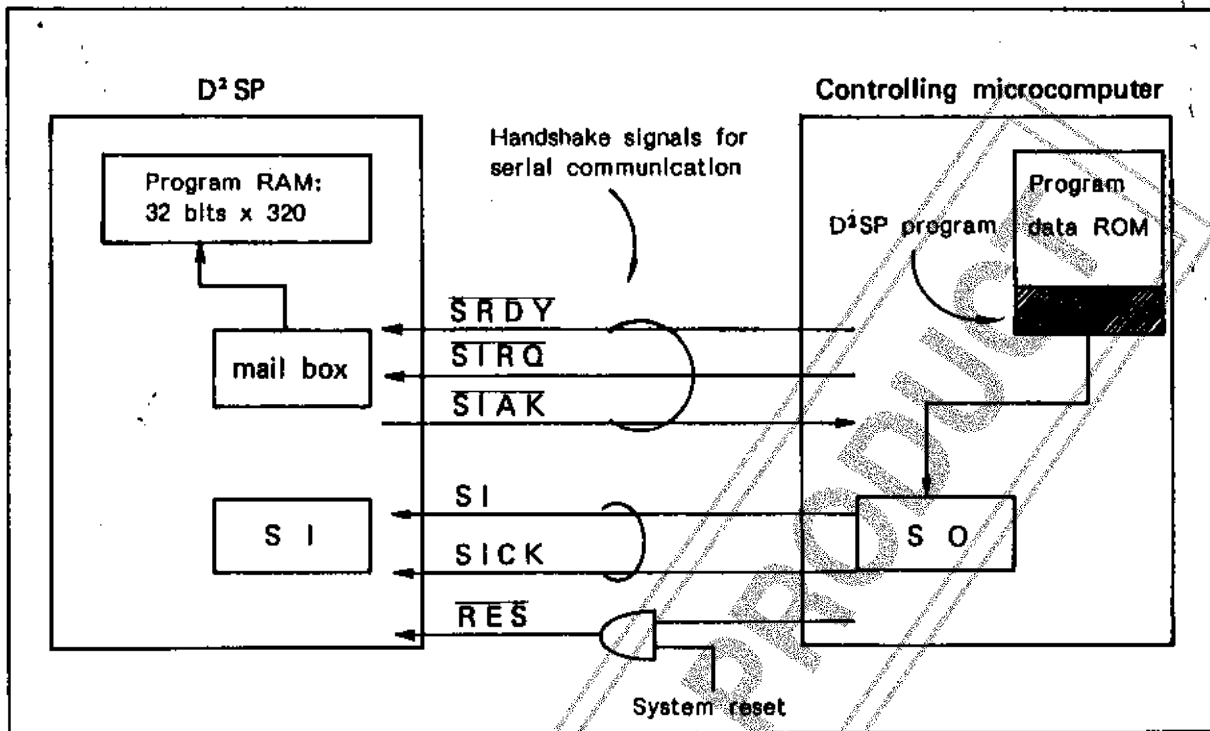

Figure A-2. Outline of an example program Boot system

8. Development tool system

- Program development flow -

Development tools are provided to help the user to easily develop application programs for the LC83010. These development tools are divided into two groups: software support tool group and hardware support tool group.

The software support tool group consists of an assembler, debugger and simulator.

The hardware support tool group is realized as an in-Circuit Emulator (ICE).

Figure A-3 shows the applications development flow for the LC83010 system.

- (1) Write an application source program.
- (2) Check the source program for syntax errors with the assembler. If every syntax error is corrected, the assembler generates a HEX program file.
- (3) Check the HEX file for operational errors with the simulator. If the desired operations are not successful, start the debugger to find what caused logical errors.
- (4) If program operations are checked successfully, use the ICE to evaluate the audio signal output. First, evaluate sound signals only with the ICE. In this evaluation process, the delay memory and microcomputer of the ICE are used. Second, start the total evaluation on an application system. In this evaluation stage, the AD/DA converters, microcomputer, and delay memory on the user application system are used.

Figure A-4 shows the entire program development tool system for the LC83010.

The software tools such as the assembler, debugger, simulator can be run on an IBM PC-AT compatible machine or an AX personal computer. The ICE is also controlled by such a host personal computer.

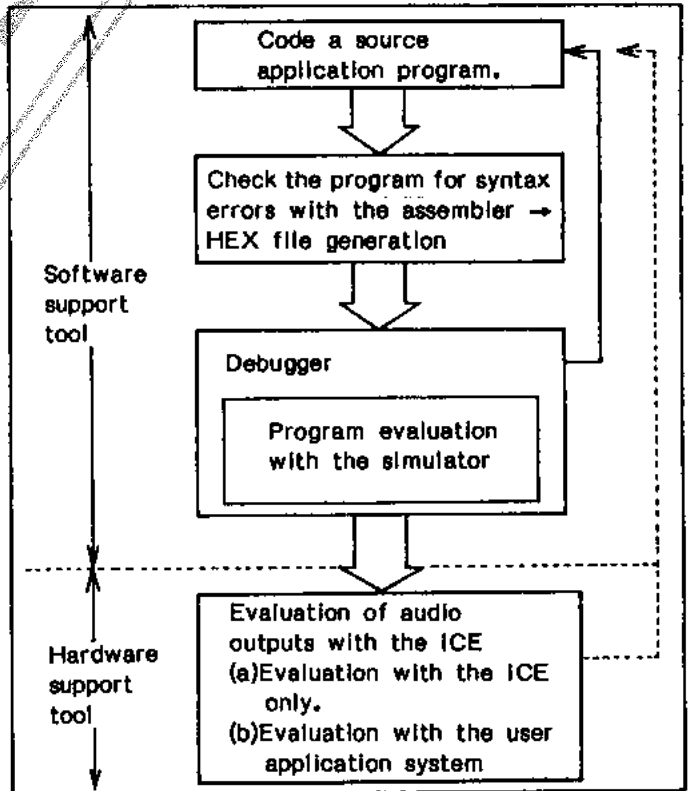

Figure A-3. Applications Development Flow

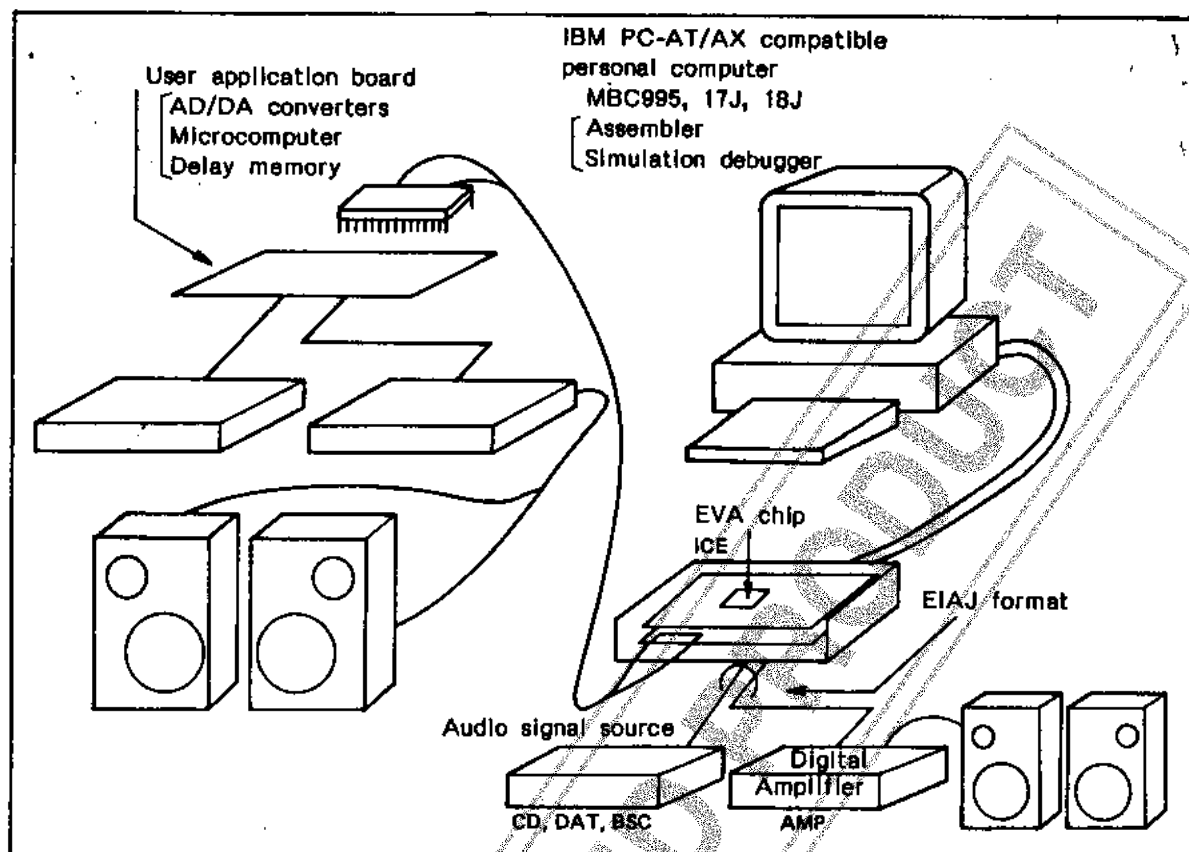

Figure A-4. Entire support tool system for microprogram development

(1) Debugger

The debugger is a software support tool designed to realize virtual LC83010 functional circuits. In this virtually emulated LC83010 environment, user application programs can be evaluated as if they were executed on the real chip. The debugger is used mainly for logics analysis and detailed data analysis. Major functions of the debugger are listed in the table below, with brief explanation for each.

- Display and Edit Instructions
These instructions can be used to display the contents of memory and registers on a screen and to update them.
- Memory Fill Instruction
This instruction is used to fill a specified memory address range with a desired value.
- Move instruction
This instruction is used to transfer the data in a specified memory address range to another range.
- Memory Load and Save Instructions
These instructions are used to transfer data between memory and disk. The memory load instruction enables the data transfer from a disk file to memory while the memory save instruction allows the data transfer from memory to a disk file.
- Assemble and Unassemble Instructions
The assemble instruction is used to convert mnemonics into machine codes.
The unassemble instruction is used to convert memory data back to mnemonics.
- Emulation instruction control instruction and Break point instruction
These instructions are used to execute the DSP program and trace its operations. The break point instruction is used to set a point where the program execution stops.

Table Major debugger functions

(2) Outline of the simulator functions

The application programs can be tested in the following sequence:

- Inputting digital audio signals to the LC83010 chip,
- Executing a program,
- Converting the audio output into analog signals, and
- Measuring the analog signals with an oscilloscope or frequency characteristics meter (or sweep meter).

The simulator enables the above operations on a personal computer.

Figure A-5 shows the signal waveform measurement.

This simulator has the following three measurement functions:

- 1) Audio output waveforms (sine waves) with respect to audio input waveforms (sine waves)
- 2) Frequency characteristics of audio output (AOUT)
- 3) Impulse response characteristics of audio output

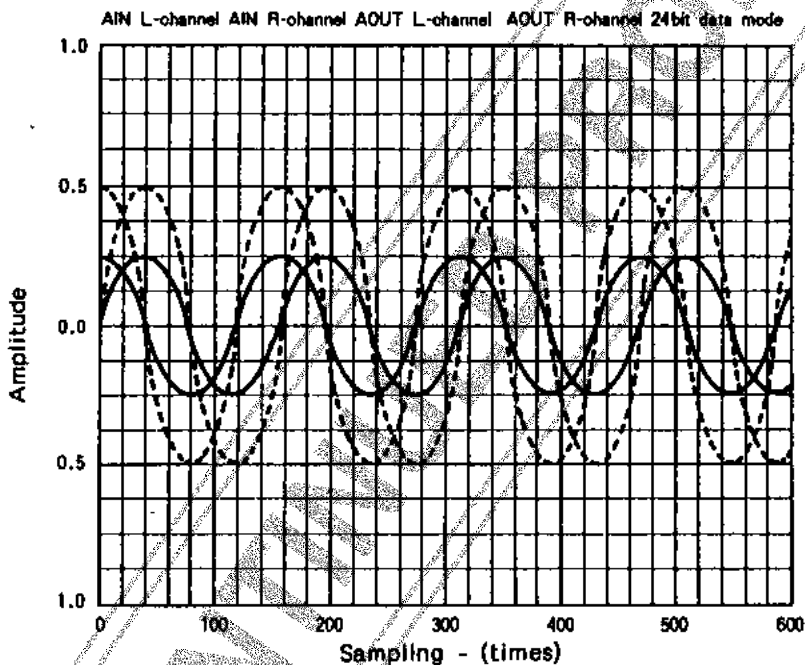

Figure A-5. Display of various waveforms

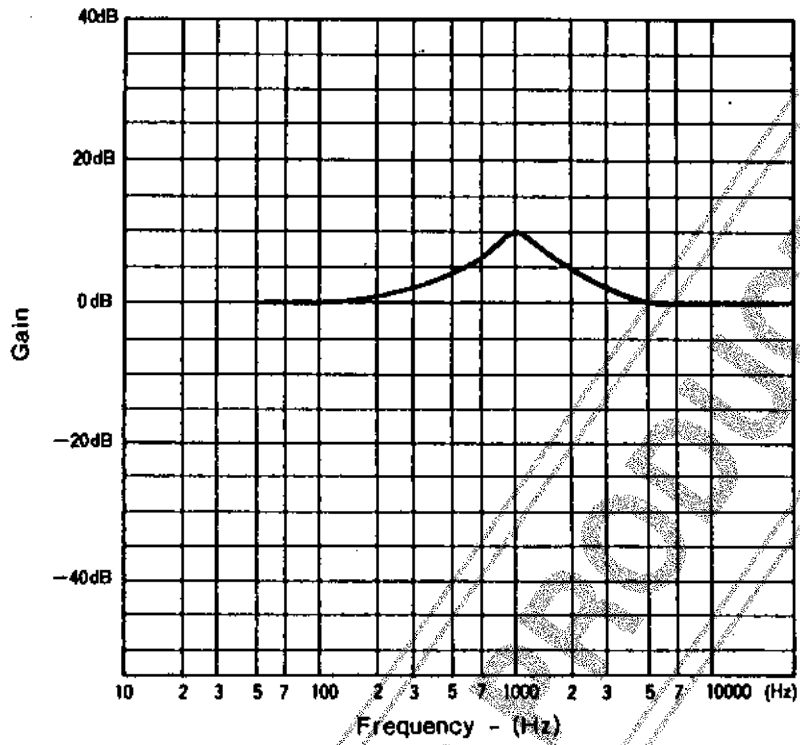

Figure A-6. Display of frequency characteristics

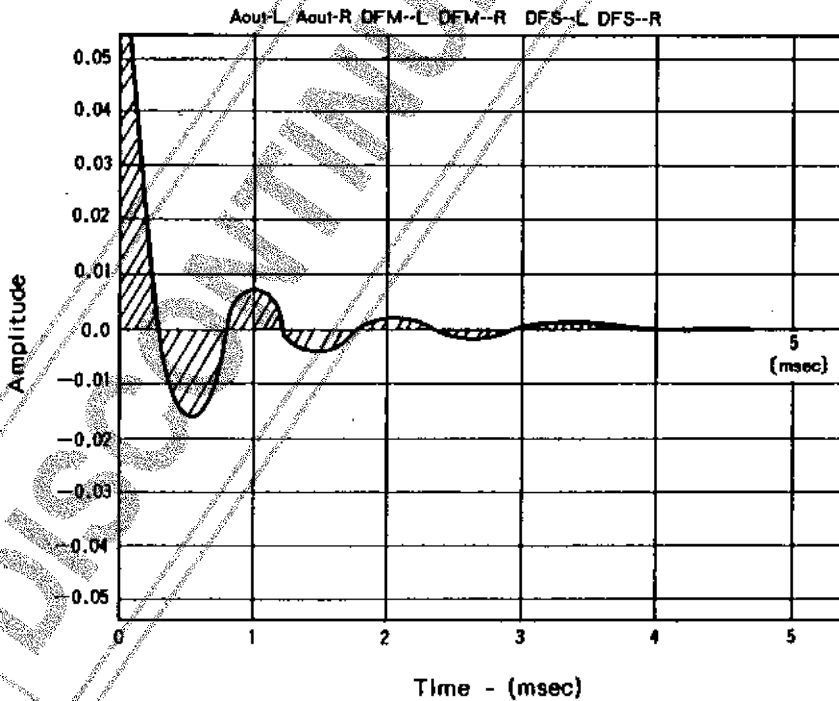

Figure A-7. Impulse response waveforms (limit cycle characteristic)

(3) ICE outline

The In-Circuit Emulator (ICE) provides an operating environment where the application program already checked by the simulation debugger is executed and then outputs audio signals. The ICE functions can be divided into two: One is the program evaluation by outputting audio signals only on the ICE. In this evaluation method, delay can be produced by the DRAM in the ICE system. The other is the final program evaluation by connecting a user application board to the ICE system. In this test method, the interfaces to the controlling microcomputer and other various peripheral LSIs on the application board can be evaluated. Figure A-8 shows the ICE system configuration for the entire evaluation using a user application board.

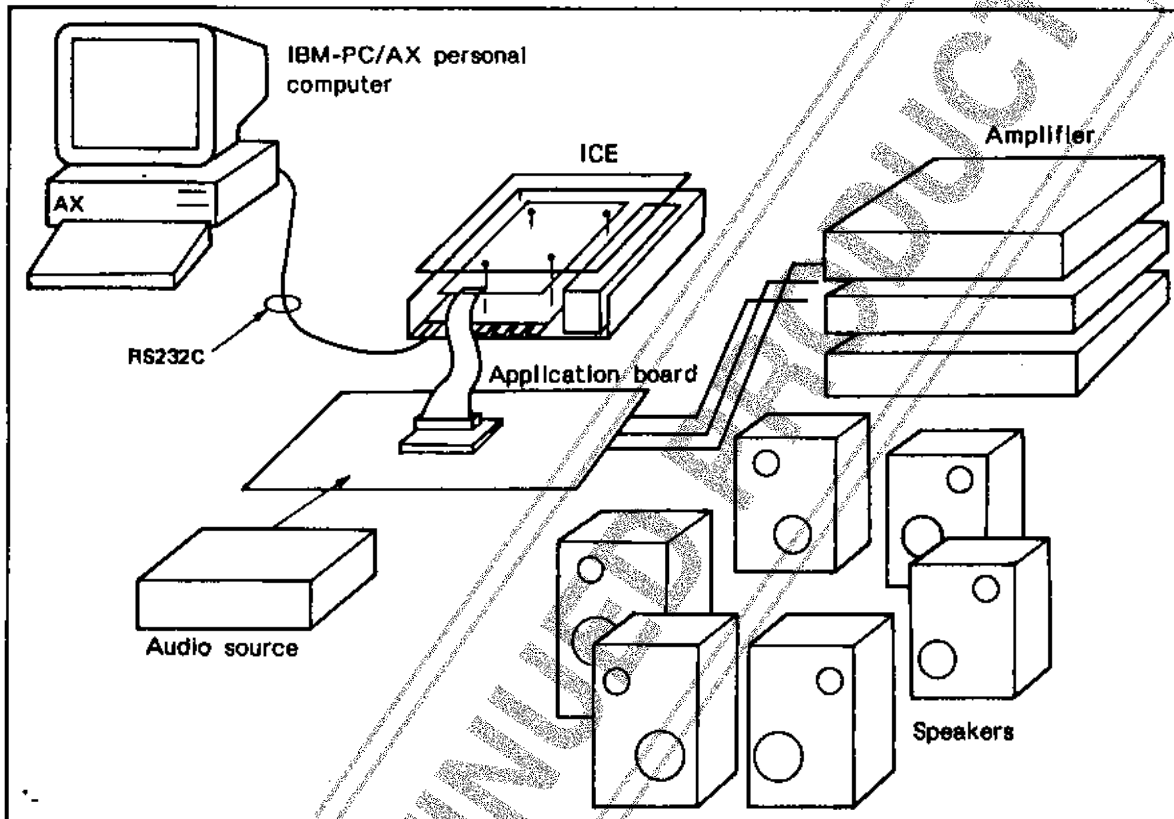

Figure A-8. Final evaluation system configuration with an application board and ICE

ICE functions

- The ICE has debugging functions.
- The ICE consists of unique hardware functions specifically designed as the ICE for audio DSP.

(a) ICE debugging functions

- (1) Execution command : Allows the program execution to continue until a break point is detected. It also enables the program execution in the step mode or in the trace mode.
- (2) Break function : Enables the user to set a desired break point.
- (3) The edit dump command is useful in displaying the conditions of a specified memory area after the break of program execution. The register edit command is used to convert the contents of a present specified register.
- (4) The memory dump command is useful in displaying the contents of a specified memory area when the program execution breaks. On the other hand, the edit command is used to edit the contents of a specified memory area when the program execution breaks.
- (5) Program modification and confirmation : Enables the user to modify part of the program and to check how it works.
- (6) Other functions : Memory management facility and so on. For details, refer the sections following section 8-3.

(b) Unique ICE hardware configuration

- (1) Audio data input/output : Direct Interface Receiver (DIR). This function allows direct input of audio digital data. Digital Interface Transmitter (DIT). This function allows direct output of 3-channel digital audio data.
- (2) DRAM : Delay DRAM for audio signal. 256k (64K x 4 bits) x 2. 1M (256K x 4 bits) x 2
- (3) Evaluation function of serial input/output : Z80 microcomputer for evaluating serial input/output. This control unit makes an access to the DSP instead of any controlling microcomputer to adjust the serial input/output operations.

Example application system

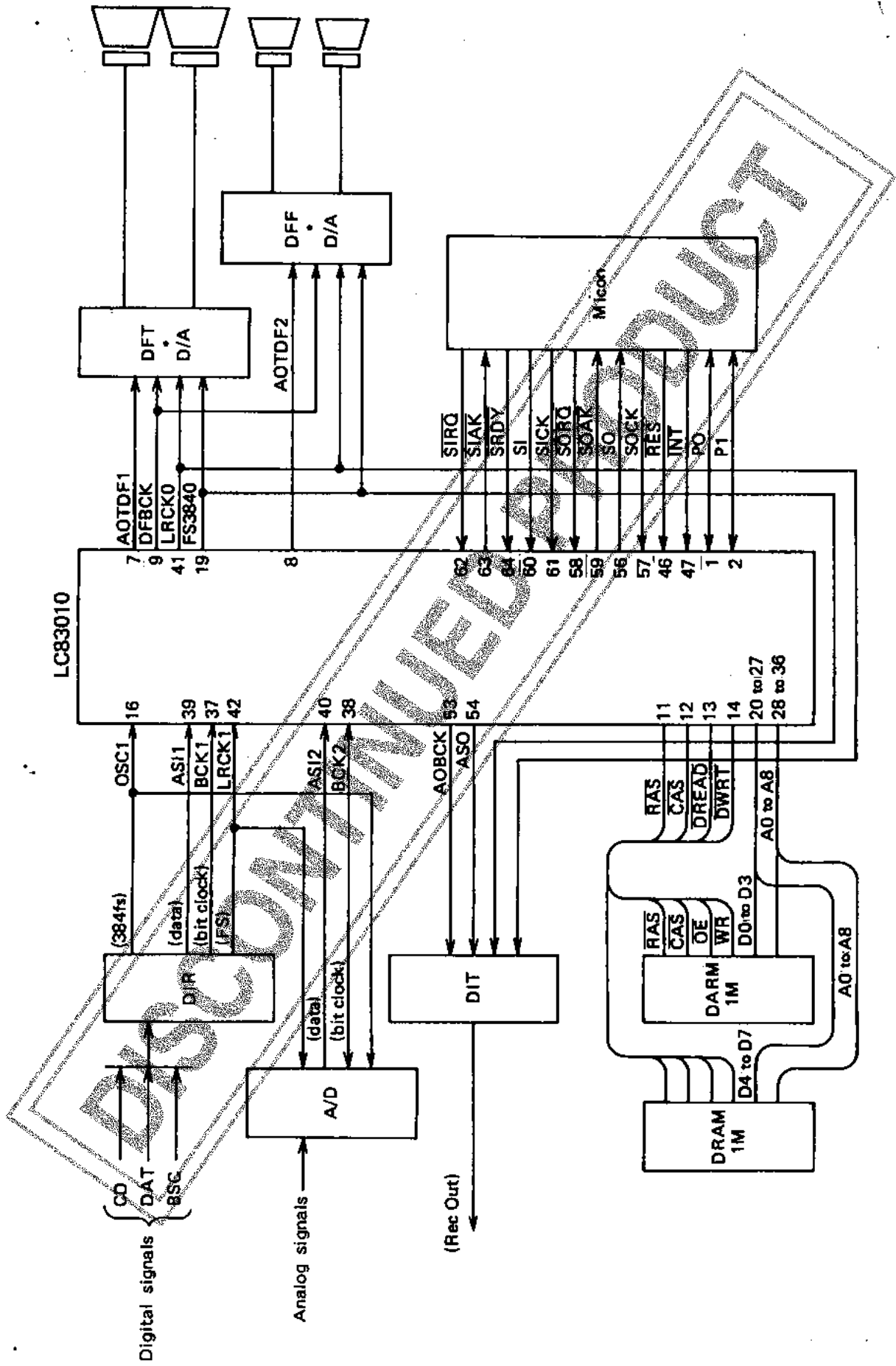

9. Instruction Bit Map

The instruction bit map is shown below.

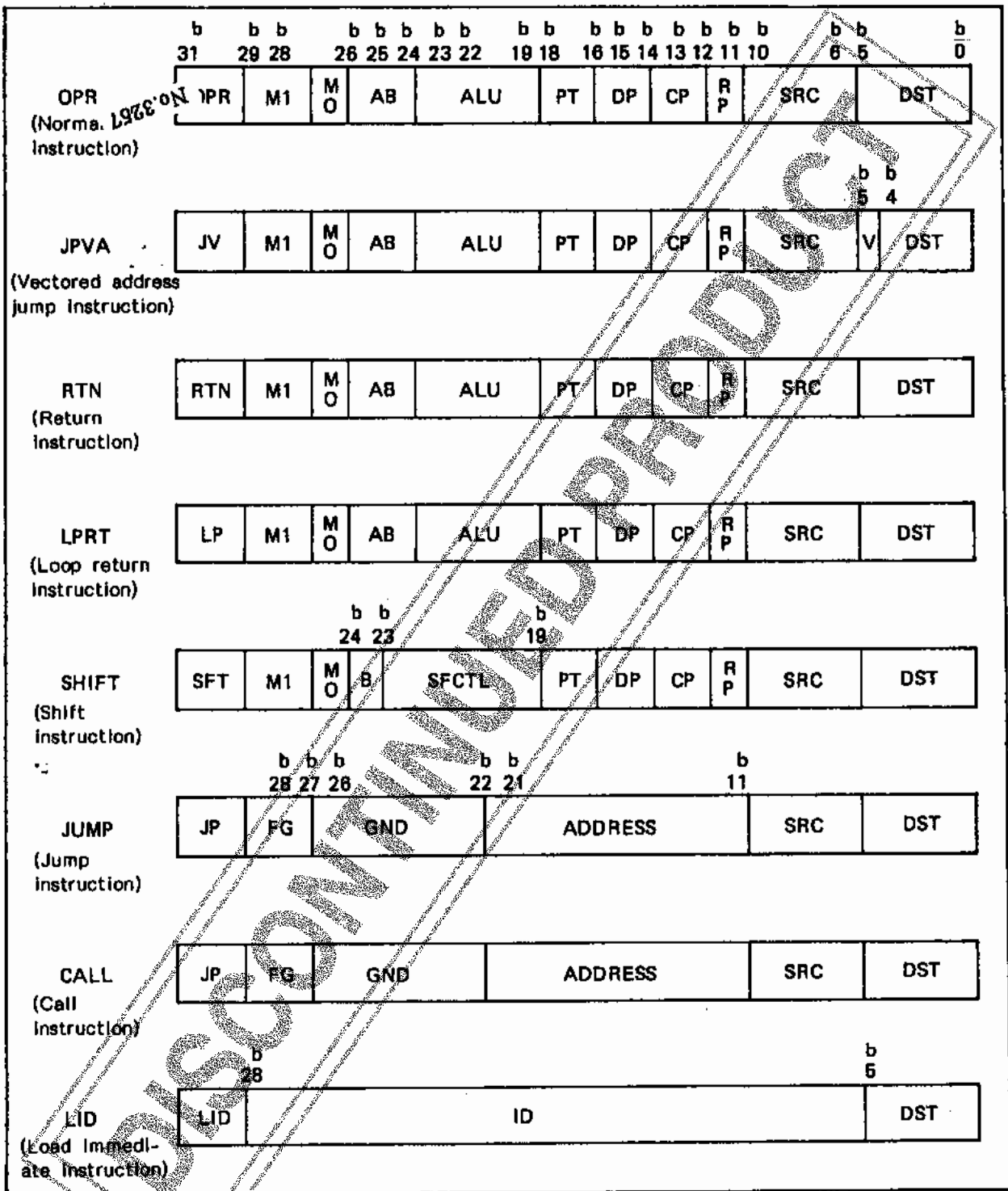

Instruction Bit Map diagram

Information (including circuit diagrams and circuit parameters) herein is for example only; it is not guaranteed for volume production. SANYO believes information herein is accurate and reliable, but no guarantees are made or implied regarding its use or any infringements of intellectual property rights or other rights of third parties.