

## DUAL J-FET INPUT OPERATIONAL AMPLIFIER

### ■ GENERAL DESCRIPTION

The NJM072B/082B & NJM072/082 are dual JFET input operational amplifiers. They feature low input bias and offset currents, high input impedance and fast slew rate. The low harmonic distortion and low noise make them ideally suit for amplifiers with high fidelity and audio amplifier applications.

The NJM072/082 may cause oscillation in some application like voltage follower.

### ■ FEATURES

- Operating Voltage (±4V~±18V)
- J-FET Input
- High Input Resistance (10<sup>12</sup>Ω typ.)
- Low Input Resistance (30pA typ.)
- High Slew Rate (13V/μs, 20V/μs typ.)
- Wide Unity Gain Bandwidth (3MHz, 5MHz typ.)
- Package Outline DIP8, DMP8, SSOP8, SIP8
- Bipolar Technology

### ■ PACKAGE OUTLINE

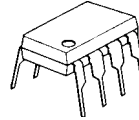

NJM072BD/082BD  
NJM072D/082D



NJM072BM/082BM  
NJM072M/082M



NJM072BV/082BV

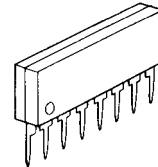

NJM072BL/082BL  
NJM072L/082L

### ■ PIN CONFIGURATION

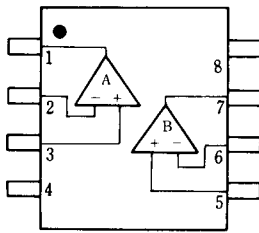

NJM072BD/082BD  
NJM072D/082D  
NJM072M/082M  
NJM072BM/082BM  
NJM072BV/082BV

#### PIN FUNCTION

1. A OUTPUT
2. A -INPUT
3. A +INPUT
4. V<sup>-</sup>
5. B +INPUT
6. B -INPUT
7. B OUTPUT
8. V<sup>+</sup>

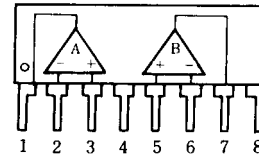

NJM072L/082L  
NJM072BL/082BL

### ■ EQUIVALENT CIRCUIT

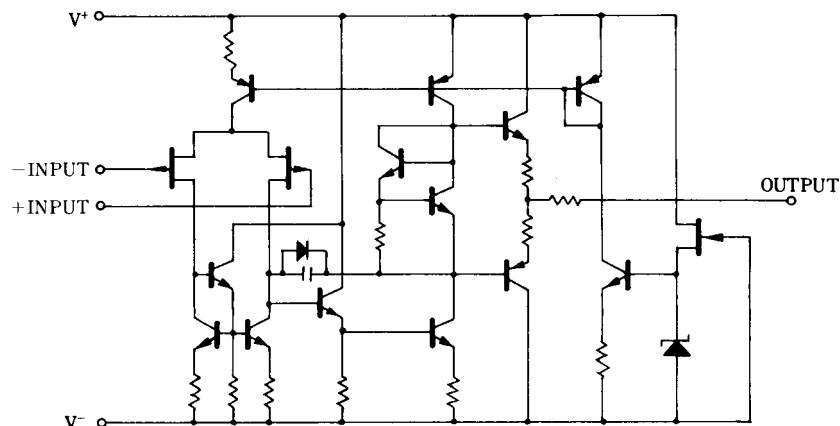

# NJM072B/082B/072/082

## ■ ABSOLUTE MAXIMUM RATINGS

( Ta=25°C )

PARAMETER	SYMBOL	RATINGS	UNIT
Supply Voltage	$V^+ / V^-$	± 18	V
Input Voltage	$V_{IC}$	± 15	V
Differential Input Voltage	$V_{ID}$	± 30	V
Power Dissipation	$P_D$	( DIP8 ) 500 ( DMP8 ) 300 ( SSOP8 ) 300 ( SIP8 ) 800	mW
Operating Temperature Range	$T_{opr}$	-40~+85	°C
Storage Temperature Range	$T_{stg}$	-40~+125	°C

## ■ ELECTRICAL CHARACTERISTICS ( Ta=+25°C, $V^+ / V^- = \pm 15V$ )

( ) Applies to NJM082B, NJM082

PARAMETER	SYMBOL	TEST CONDITION	MIN.	TYP.	MAX.	UNIT
Input Offset Voltage	$V_{IO}$	$R_S = 50\Omega$	-	3 (5)	10 (15)	mV
Input Offset Current	$I_{IO}$		-	5	50 (200)	pA
Input Bias Current	$I_B$		-	30	200 (400)	pA
Input Common Mode Voltage Range	$V_{ICM}$		± 10	-	-	V
Maximum Peak-to-peak Output Voltage Swing	$V_{OPP}$	$R_L = 10k\Omega$	24	27	-	$V_{P-P}$
Large-Signal Voltage Gain	$A_V$	$R_L \geq 2k\Omega, V_O = \pm 10V$	88	106	-	dB
Unity Gain Bandwidth	$f_T$	072B/082B	-	3	-	MHz
		072/082	-	5	-	MHz
Input Resistance	$R_{IN}$		-	$10^{12}$	-	$\Omega$
Common Mode Rejection Ratio	CMR	$R_S \leq 10k\Omega$	70	76	-	dB
Supply Voltage Rejection Ratio	SVR	$R_S \leq 10k\Omega$	70	76	-	dB
Operating Current	$I_{CC}$		-	3	5 (5.6)	mA
Slew Rate	SR	072B/082B	-	13	-	V/ $\mu$ s
		072/082	-	20	-	V/ $\mu$ s
Equivalent Input Noise Voltage	$V_{NI}$	$R_S = 100\Omega, B.W. = 10 \sim 10kHz$	-	4	-	$\mu V_{rms}$

## ■ NOTICE WHEN APPLICATION

Recommendable product

072/082 are the products in which the AC feature have been made much higher comparing to the products of 072B/082B which are compatible with 072/082 type of other company's products. Therefore, 072/082 are unstable in oscillation when the voltage follower application, and it is recommendable to use the standard type 072B/082B when newly designed. Beside these products, we have NJM2082 which is higher up in AC feature, yet stability in oscillation, and then the driving capacity to the load at the output stage is made much higher in operation.

## ■ TYPICAL CHARACTERISTICS

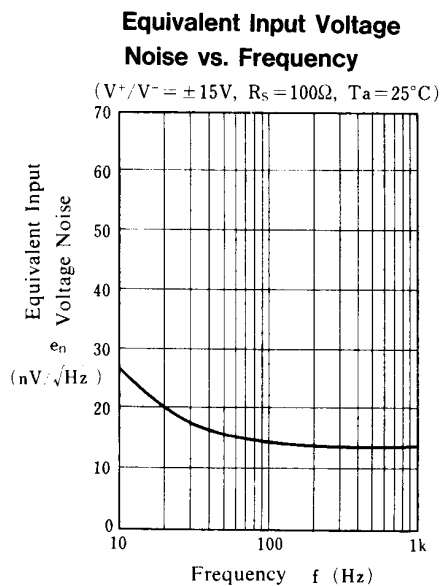
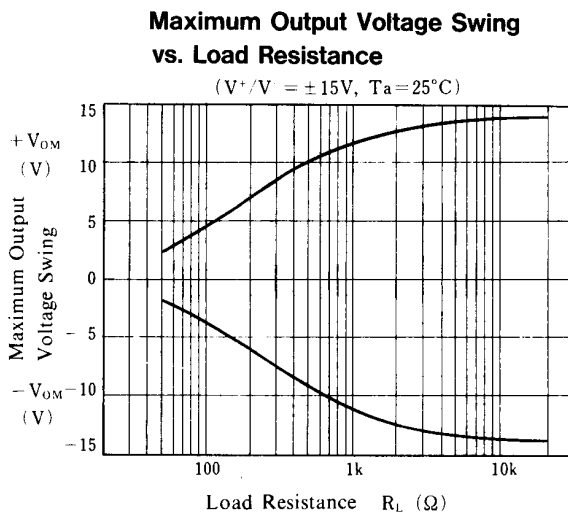
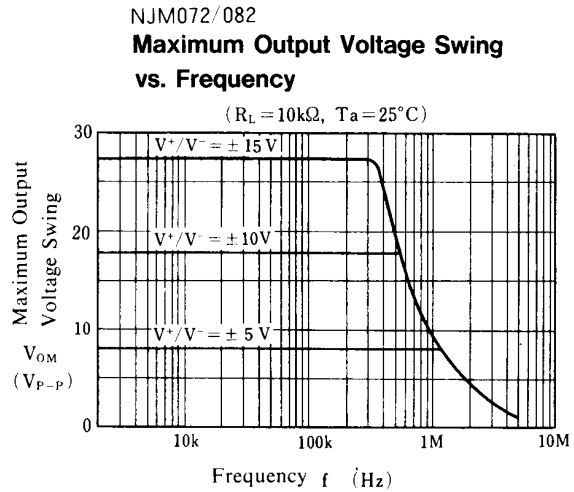
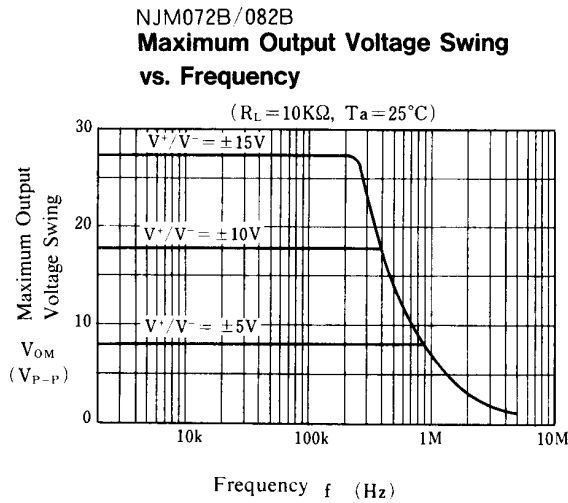
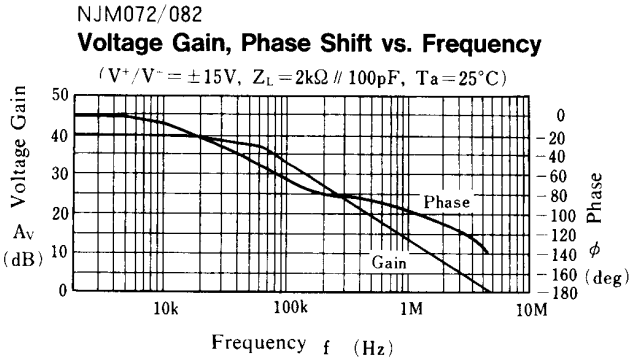
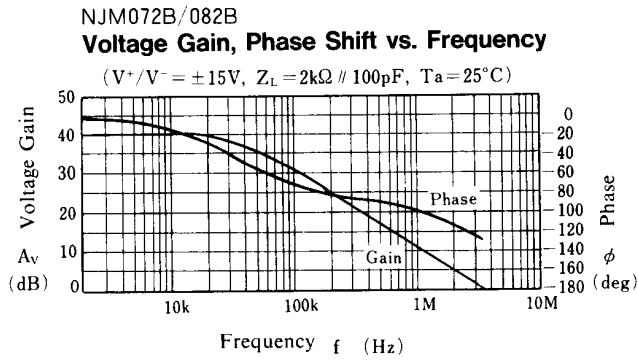

## ■ TYPICAL CHARACTERISTICS

### Operating Current vs. Temperature

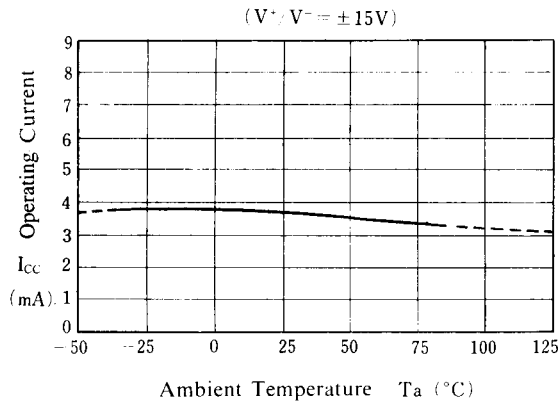

### Maximum Output Voltage Swing vs. Temperature

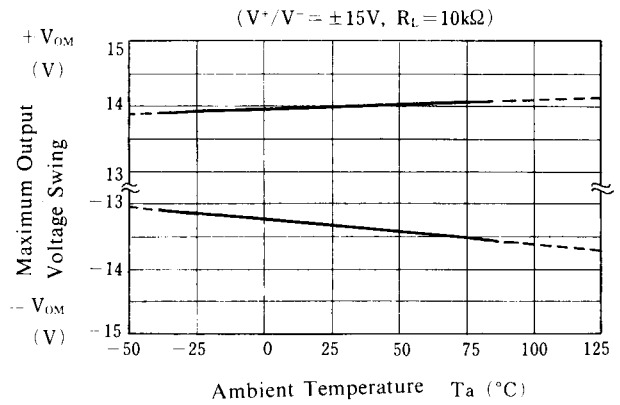

### Input Offset Voltage vs. Temperature

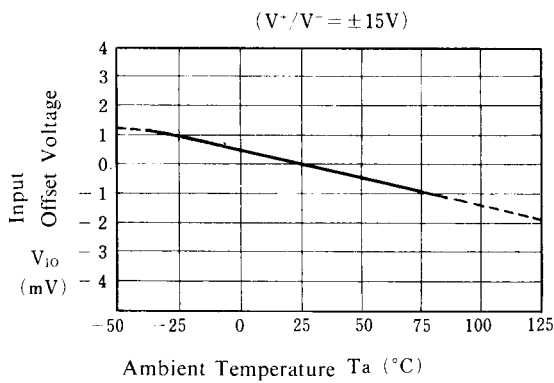

### Input Bias Current vs. Temperature

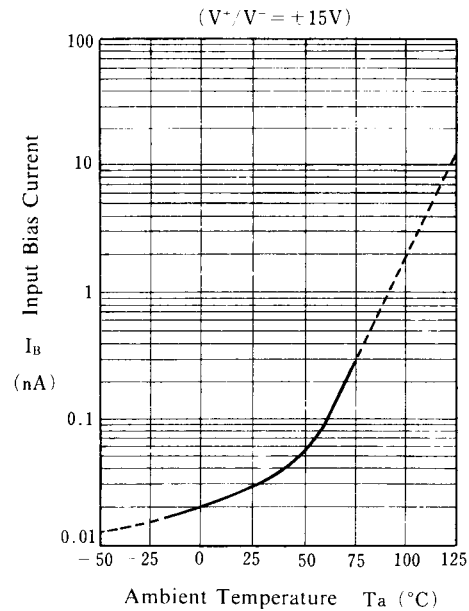

### Operating Current vs. Operating Voltage

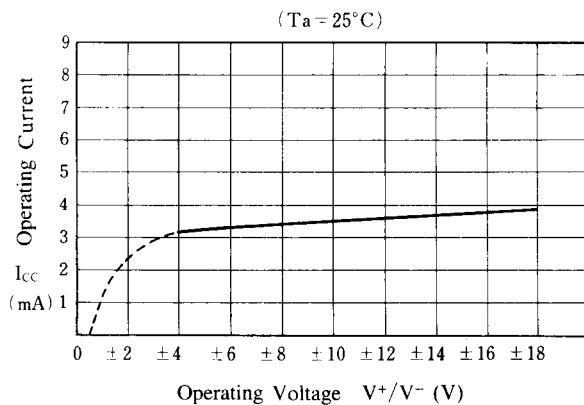

### Maximum Output Voltage Swing vs. Operating Voltage

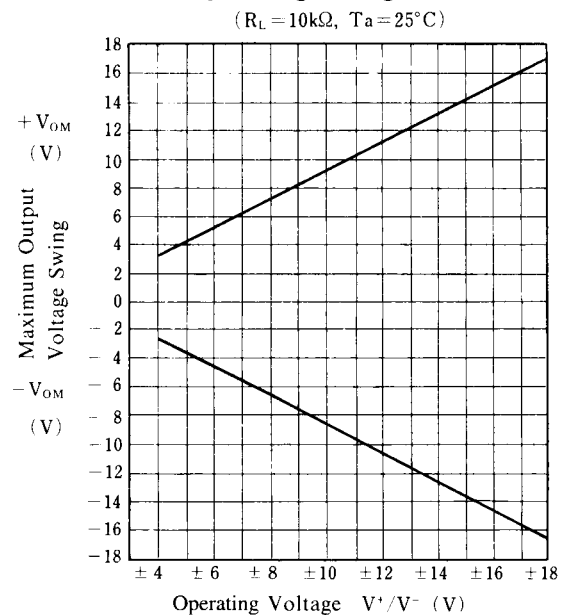

**[CAUTION]**

The specifications on this databook are only given for information, without any guarantee as regards either mistakes or omissions. The application circuits in this data book are described only to show representative usages of the product and not intended for the guarantee or permission of any right including the industrial rights.