

## Low Voltage 1:18 Clock Distribution Chip

The MPC9109 is a 1:18 low voltage clock distribution chip with 2.5V or 3.3V LVCMOS output capabilities. The device features the capability to select either a differential LVPECL or an LVCMOS compatible input. The 18 outputs are 2.5V or 3.3V LVCMOS compatible and feature the drive strength to drive 50Ω series or parallel terminated transmission lines. With output-to-output skews of 200ps, the MPC9109 is ideal as a clock distribution chip for the most demanding of synchronous systems. The 2.5V outputs also make the device ideal for supplying clocks for a high performance Pentium II™ microprocessor based design. For a higher performance version of the 9109 refer to the MPC940L data sheet.

- LVPECL or LVCMOS Clock Input
- 2.5V LVCMOS Outputs for Pentium II Microprocessor Support
- 200ps Maximum Output-to-Output Skew @ 3.3V Output
- Maximum Output Frequency of 250MHz @ 3.3V Core
- 32-Lead QFP Packaging
- Dual or Single Supply Device:
  - Dual V<sub>CC</sub> Supply Voltage, 3.3V Core and 2.5V Output
  - Single 3.3V V<sub>CC</sub> Supply Voltage for 3.3V Outputs
  - Single 2.5V V<sub>CC</sub> Supply Voltage for 2.5V I/O

With a low output impedance ( $\approx 20\Omega$ ), in both the HIGH and LOW logic states, the output buffers of the MPC9109 are ideal for driving series terminated transmission lines. With a 20Ω output impedance the 9109 has the capability of driving two series terminated lines from each output. This gives the device an effective fanout of 1:36. If a lower output impedance is desired please see the MPC942 data sheet. If better performance is desired please see the MPC940L data sheet.

The differential LVPECL inputs of the MPC9109 allow the device to interface directly with a LVPECL fanout buffer like the MC100EP111 to build very wide clock fanout trees or to couple to a high frequency clock source. The LVCMOS input provides a more standard interface for applications requiring only a single clock distribution chip at relatively low frequencies. In addition, the two clock sources can be used to provide for a test clock interface as well as the primary system clock. A logic HIGH on the LVCMOS\_CLK\_Sel pin will select the LVCMOS level clock input. All inputs of the MPC9109 have internal pullup/pulldown resistor so they can be left open if unused.

The MPC9109 is a single or dual supply device. The device power supply offers a high degree of flexibility. The device can operate with a 3.3V core and 3.3V output, a 3.3V core and 2.5V outputs as well as a 2.5V core and 2.5V outputs. The 32-lead QFP package was chosen to optimize performance, board space and cost of the device. The 32-lead TQFP has a 7x7mm body size with a conservative 0.8mm pin spacing.

**MPC9109**

**LOW VOLTAGE  
1:18 CLOCK  
DISTRIBUTION CHIP**



**FA SUFFIX**  
32-LEAD QFP PACKAGE  
CASE 873A-02

Pentium II is a trademark of Intel Corporation.



**LOGIC DIAGRAM**

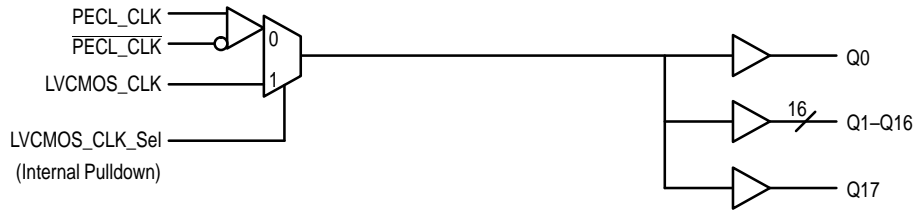

**Pinout: 32-Lead TQFP (Top View)**

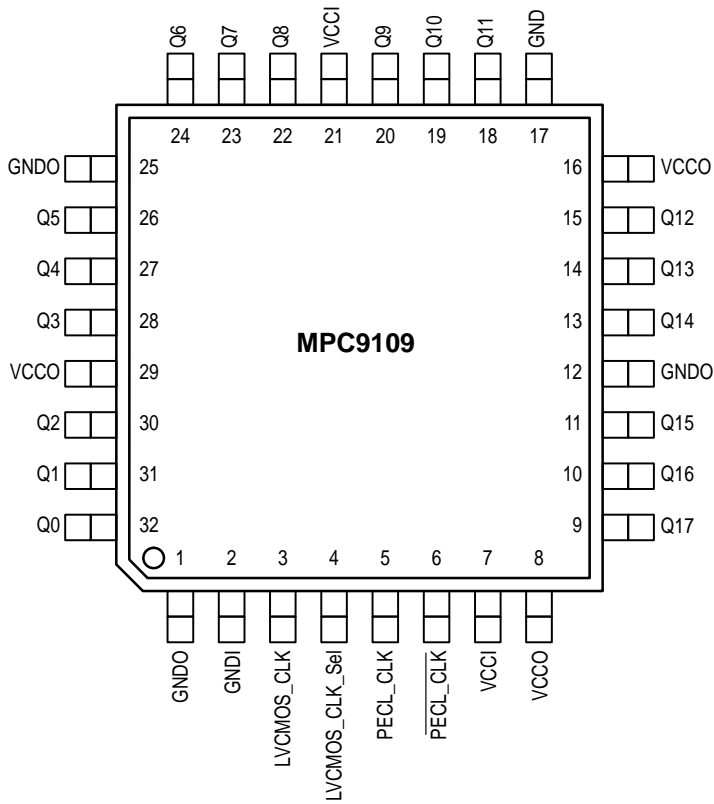

**FUNCTION TABLE**

LVC MOS_CLK_Sel	Input
0	PECL_CLK
1	LVC MOS_CLK

**POWER SUPPLY VOLTAGES**

Supply Pin	Voltage Level
VCCI	2.5V or 3.3V ± 5%
VCCO	2.5V or 3.3V ± 5%

**ABSOLUTE MAXIMUM RATINGS\***

Symbol	Parameter	Min	Max	Unit
V <sub>CC</sub>	Supply Voltage	-0.3	3.6	V
V <sub>I</sub>	Input Voltage	-0.3	V <sub>CC</sub> + 0.3	V
I <sub>IN</sub>	Input Current		±20	mA
T <sub>Stor</sub>	Storage Temperature Range	-40	125	°C

\* Absolute maximum continuous ratings are those values beyond which damage to the device may occur. Exposure to these conditions or conditions beyond those indicated may adversely affect device reliability. Functional operation under absolute-maximum-rated conditions is not implied.

**DC CHARACTERISTICS** (T<sub>A</sub> = 0° to 70°C, V<sub>CCI</sub> = 3.3V ±5%; V<sub>CCO</sub> = 3.3V ±5%)

Symbol	Characteristic	Min	Typ	Max	Unit	Condition
V <sub>IH</sub>	Input HIGH Voltage	CMOS_CLK	2.4	V <sub>CCI</sub>	V	
V <sub>IL</sub>	Input LOW Voltage	CMOS_CLK		0.8	V	
V <sub>PP</sub>	Peak-to-Peak Input Voltage	PECL_CLK	500	1000	mV	
V <sub>CMR</sub>	Common Mode Range	PECL_CLK	V <sub>CC</sub> -1.4	V <sub>CC</sub> -0.6	V	
V <sub>OH</sub>	Output HIGH Voltage		2.4		V	I <sub>OH</sub> = -20mA
V <sub>OL</sub>	Output LOW Voltage			0.5	V	I <sub>OH</sub> = 20mA
I <sub>IN</sub>	Input Current			±200	μA	
C <sub>IN</sub>	Input Capacitance		4.0		pF	
C <sub>pd</sub>	Power Dissipation Capacitance		10		pF	per output
Z <sub>OUT</sub>	Output Impedance	18	23	28	Ω	
I <sub>CC</sub>	Maximum Quiescent Supply Current		0.5		mA	

**AC CHARACTERISTICS** (T<sub>A</sub> = 0° to 70°C, V<sub>CCI</sub> = 3.3V ±5%; V<sub>CCO</sub> = 3.3V ±5%)

Symbol	Characteristic	Min	Typ	Max	Unit	Condition	
F <sub>max</sub>	Maximum Input Frequency			250	MHz		
t <sub>PLH</sub>	Propagation Delay	PECL_CLK CMOS_CLK	1.8 1.6	2.8 2.5	3.8 3.3	ns	Note 1
t <sub>sk(o)</sub>	Output-to-Output Skew	PECL_CLK CMOS_CLK			200 200	ps	Note 1.
t <sub>sk(pr)</sub>	Part-to-Part Skew	PECL_CLK CMOS_CLK			2.0 1.7	ns	Note 1.
d <sub>t</sub>	Duty Cycle		45		55	%	Note 1.
t <sub>r</sub> , t <sub>f</sub>	Output Rise/Fall Time		0.1		1.3	ns	Note 1.

1. Guaranteed by statistical analysis, not 100% tested in production.

**ABSOLUTE MAXIMUM RATINGS\***

Symbol	Parameter	Min	Max	Unit
V <sub>CC</sub>	Supply Voltage	-0.3	3.6	V
V <sub>I</sub>	Input Voltage	-0.3	V <sub>CC</sub> + 0.3	V
I <sub>IN</sub>	Input Current		±20	mA
T <sub>Stor</sub>	Storage Temperature Range	-40	125	°C

\* Absolute maximum continuous ratings are those values beyond which damage to the device may occur. Exposure to these conditions or conditions beyond those indicated may adversely affect device reliability. Functional operation under absolute-maximum-rated conditions is not implied.

**DC CHARACTERISTICS** (T<sub>A</sub> = 0° to 70°C, V<sub>CCI</sub> = 3.3V ±5%; V<sub>CCO</sub> = 2.5V ±5%)

Symbol	Characteristic	Min	Typ	Max	Unit	Condition
V <sub>IH</sub>	Input HIGH Voltage	CMOS_CLK	2.4	V <sub>CCI</sub>	V	
V <sub>IL</sub>	Input LOW Voltage	CMOS_CLK		0.8	V	
V <sub>PP</sub>	Peak-to-Peak Input Voltage	PECL_CLK	500	1000	mV	
V <sub>CMR</sub>	Common Mode Range	PECL_CLK	V <sub>CC</sub> -1.4	V <sub>CC</sub> -0.6	V	
V <sub>OH</sub>	Output HIGH Voltage		1.8		V	I <sub>OH</sub> = -20mA
V <sub>OL</sub>	Output LOW Voltage			0.5	V	I <sub>OH</sub> = 20mA
I <sub>IN</sub>	Input Current			±200	μA	
C <sub>IN</sub>	Input Capacitance		4.0		pF	
C <sub>pd</sub>	Power Dissipation Capacitance		10		pF	per output
Z <sub>OUT</sub>	Output Impedance		23		Ω	
I <sub>CC</sub>	Maximum Quiescent Supply Current		0.5		mA	

**AC CHARACTERISTICS** (T<sub>A</sub> = 0° to 70°C, V<sub>CCI</sub> = 3.3V ±5%; V<sub>CCO</sub> = 2.5V ±5%)

Symbol	Characteristic	Min	Typ	Max	Unit	Condition	
F <sub>max</sub>	Maximum Input Frequency			250	MHz		
t <sub>PLH</sub>	Propagation Delay	PECL_CLK CMOS_CLK	1.8 1.6	2.8 2.5	3.9 3.4	ns	Note 1
t <sub>sk(o)</sub>	Output-to-Output Skew	PECL_CLK CMOS_CLK			250 250	ps	Note 1.
t <sub>sk(pr)</sub>	Part-to-Part Skew	PECL_CLK CMOS_CLK			2.1 1.8	ns	Note 1.
d <sub>t</sub>	Duty Cycle		45		55	%	Note 1.
t <sub>r</sub> , t <sub>f</sub>	Output Rise/Fall Time		0.1		1.3	ns	Note 1.

1. Guaranteed by statistical analysis, not 100% tested in production.

**ABSOLUTE MAXIMUM RATINGS\***

Symbol	Parameter	Min	Max	Unit
V <sub>CC</sub>	Supply Voltage	-0.3	3.6	V
V <sub>I</sub>	Input Voltage	-0.3	V <sub>CC</sub> + 0.3	V
I <sub>IN</sub>	Input Current		±20	mA
T <sub>Stor</sub>	Storage Temperature Range	-40	125	°C

\* Absolute maximum continuous ratings are those values beyond which damage to the device may occur. Exposure to these conditions or conditions beyond those indicated may adversely affect device reliability. Functional operation under absolute-maximum-rated conditions is not implied.

**DC CHARACTERISTICS** (T<sub>A</sub> = 0° to 70°C, V<sub>CCI</sub> = 2.5V ±5%; V<sub>CCO</sub> = 2.5V ±5%)

Symbol	Characteristic	Min	Typ	Max	Unit	Condition
V <sub>IH</sub>	Input HIGH Voltage	CMOS_CLK	2.0	V <sub>CCI</sub>	V	
V <sub>IL</sub>	Input LOW Voltage	CMOS_CLK		0.8	V	
V <sub>PP</sub>	Peak-to-Peak Input Voltage	PECL_CLK	500	1000	mV	
V <sub>CMR</sub>	Common Mode Range	PECL_CLK	V <sub>CC</sub> -1.0	V <sub>CC</sub> -0.6	V	
V <sub>OH</sub>	Output HIGH Voltage		1.8		V	I <sub>OH</sub> = -12mA
V <sub>OL</sub>	Output LOW Voltage			0.5	V	I <sub>OH</sub> = 12mA
I <sub>IN</sub>	Input Current			±200	μA	
C <sub>IN</sub>	Input Capacitance		4.0		pF	
C <sub>pd</sub>	Power Dissipation Capacitance		10		pF	per output
Z <sub>OUT</sub>	Output Impedance	18	23	28	Ω	
I <sub>CC</sub>	Maximum Quiescent Supply Current		0.5		mA	

**AC CHARACTERISTICS** (T<sub>A</sub> = 0° to 70°C, V<sub>CCI</sub> = 2.5V ±5%; V<sub>CCO</sub> = 2.5V ±5%)

Symbol	Characteristic	Min	Typ	Max	Unit	Condition	
F <sub>max</sub>	Maximum Input Frequency			200	MHz		
t <sub>PLH</sub>	Propagation Delay	PECL_CLK CMOS_CLK	2.2 2.0	2.8 2.5	4.9 4.2	ns	Note 1
t <sub>sk(o)</sub>	Output-to-Output Skew	PECL_CLK CMOS_CLK			250 250	ps	Note 1.
t <sub>sk(pr)</sub>	Part-to-Part Skew	PECL_CLK CMOS_CLK			2.7 2.2	ns	Note 1.
d <sub>t</sub>	Duty Cycle		45		55	%	Note 1.
t <sub>r</sub> , t <sub>f</sub>	Output Rise/Fall Time		0.1		1.3	ns	Note 1.

1. Guaranteed by statistical analysis, not 100% tested in production.

OUTLINE DIMENSIONS

FA SUFFIX  
QFP PACKAGE  
CASE 873A-02  
ISSUE A

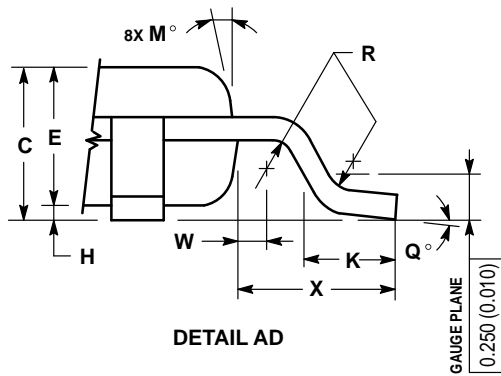
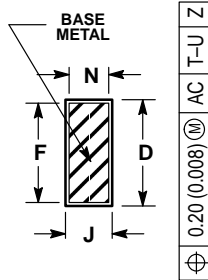
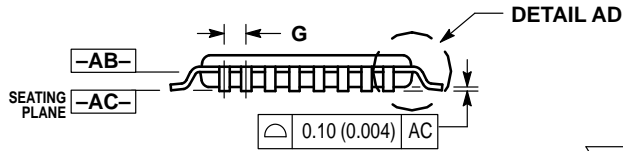
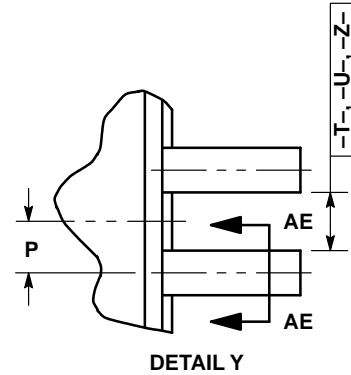
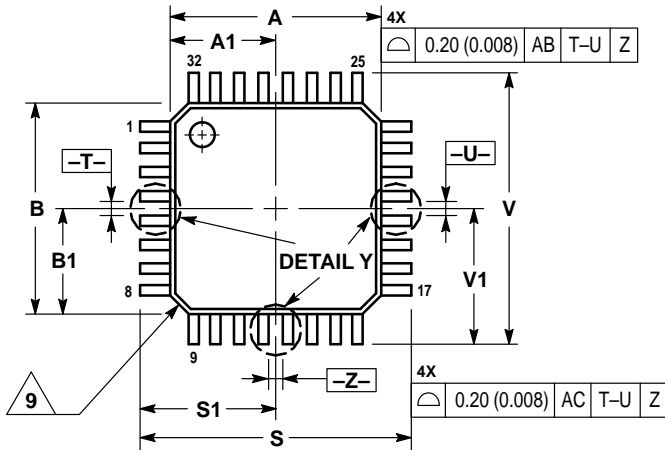

NOTES:

1. DIMENSIONING AND TOLERANCING PER ANSI Y14.5M, 1982.
2. CONTROLLING DIMENSION: MILLIMETER.
3. DATUM PLANE -AB- IS LOCATED AT BOTTOM OF LEAD AND IS COINCIDENT WITH THE LEAD WHERE THE LEAD EXITS THE PLASTIC BODY AT THE BOTTOM OF THE PARTING LINE.
4. DATUMS -T-, -U-, AND -Z- TO BE DETERMINED AT DATUM PLANE -AB-.
5. DIMENSIONS S AND V TO BE DETERMINED AT SEATING PLANE -AC-.
6. DIMENSIONS A AND B DO NOT INCLUDE MOLD PROTRUSION. ALLOWABLE PROTRUSION IS 0.250 (0.010) PER SIDE. DIMENSIONS A AND B DO INCLUDE MOLD MISMATCH AND ARE DETERMINED AT DATUM PLANE -AB-.
7. DIMENSION D DOES NOT INCLUDE DAMBAR PROTRUSION. DAMBAR PROTRUSION SHALL NOT CAUSE THE D DIMENSION TO EXCEED 0.520 (0.020).
8. MINIMUM SOLDER PLATE THICKNESS SHALL BE 0.0076 (0.0003).
9. EXACT SHAPE OF EACH CORNER MAY VARY FROM DEPICTION.

DIM	MILLIMETERS		INCHES	
	MIN	MAX	MIN	MAX
A	7.000 BSC		0.276 BSC	
A1	3.500 BSC		0.138 BSC	
B	7.000 BSC		0.276 BSC	
B1	3.500 BSC		0.138 BSC	
C	1.400	1.600	0.055	0.063
D	0.300	0.450	0.012	0.018
E	1.350	1.450	0.053	0.057
F	0.300	0.400	0.012	0.016
G	0.800 BSC		0.031 BSC	
H	0.050	0.150	0.002	0.006
J	0.090	0.200	0.004	0.008
K	0.500	0.700	0.020	0.028
M	12° REF		12° REF	
N	0.090	0.160	0.004	0.006
P	0.400 BSC		0.016 BSC	
Q	1°	5°	1°	5°
R	0.150	0.250	0.006	0.010
S	9.000 BSC		0.354 BSC	
S1	4.500 BSC		0.177 BSC	
V	9.000 BSC		0.354 BSC	
V1	4.500 BSC		0.177 BSC	
W	0.200 REF		0.008 REF	
X	1.000 REF		0.039 REF	

# NOTES

Motorola reserves the right to make changes without further notice to any products herein. Motorola makes no warranty, representation or guarantee regarding the suitability of its products for any particular purpose, nor does Motorola assume any liability arising out of the application or use of any product or circuit, and specifically disclaims any and all liability, including without limitation consequential or incidental damages. "Typical" parameters which may be provided in Motorola data sheets and/or specifications can and do vary in different applications and actual performance may vary over time. All operating parameters, including "Typicals" must be validated for each customer application by customer's technical experts. Motorola does not convey any license under its patent rights nor the rights of others. Motorola products are not designed, intended, or authorized for use as components in systems intended for surgical implant into the body, or other applications intended to support or sustain life, or for any other application in which the failure of the Motorola product could create a situation where personal injury or death may occur. Should Buyer purchase or use Motorola products for any such unintended or unauthorized application, Buyer shall indemnify and hold Motorola and its officers, employees, subsidiaries, affiliates, and distributors harmless against all claims, costs, damages, and expenses, and reasonable attorney fees arising out of, directly or indirectly, any claim of personal injury or death associated with such unintended or unauthorized use, even if such claim alleges that Motorola was negligent regarding the design or manufacture of the part. Motorola and  are registered trademarks of Motorola, Inc. Motorola, Inc. is an Equal Opportunity/Affirmative Action Employer.

Mfax is a trademark of Motorola, Inc.

**How to reach us:**

**USA/EUROPE/Locations Not Listed:** Motorola Literature Distribution;  
P.O. Box 5405, Denver, Colorado 80217. 1-303-675-2140 or 1-800-441-2447

**JAPAN:** Nippon Motorola Ltd.; SPD, Strategic Planning Office, 141,  
4-32-1 Nishi-Gotanda, Shinagawa-ku, Tokyo, Japan. 81-3-5487-8488

**Customer Focus Center: 1-800-521-6274**

**Mfax™:** RMFAX0@email.sps.mot.com – TOUCHTONE 1-602-244-6609  
Motorola Fax Back System – US & Canada ONLY 1-800-774-1848  
– <http://sps.motorola.com/mfax/>

**ASIA/PACIFIC:** Motorola Semiconductors H.K. Ltd.; 8B Tai Ping Industrial Park,  
51 Ting Kok Road, Tai Po, N.T., Hong Kong. 852-26629298

**HOME PAGE:** <http://motorola.com/sps/>

