

Product Preview
**Super Monitor On-Screen
 Display II - 16
 CMOS**

This is a high performance HCMOS device designed to interface with a micro controller unit to allow colored symbols or characters to be displayed onto colour monitor. Because of the large number of fonts, 256 fonts including the programmable RAM fonts and fixed ROM fonts, SMOSD2 is suitable to be adopted for the multi-language monitor application especially. Its on-chip PLL allows both multisystem operation and self generation of system timing. It also minimizes the MCU's burden through its built-in RAM. By storing a full screen of data and control information, this device has a capability to carry out 'screen-refresh' without any MCU supervision.

Since there is no clearance between characters, special graphics oriented characters can be generated by combining two or more character blocks. Besides, there are two kinds of different resolutions that users can choose. By changing the number of dots per horizontal line to 320 (CGA) and 640 (VGA), smaller characters with higher resolution can be easily achieved.

Special functions such as character blinking, automatic height scaling, character/window bordering or character shadowing, four-level windows, double height and double width, and programmable vertical length of character are also incorporated. Furthermore, 8 programmable character/symbol RAM fonts are also built-in. It is much flexible to create the new symbols, icons and logo. One special attractive application of the RAM fonts is the real-time programming to achieve the dynamic image instead of the static picture as previous.

- Totally 256 Characters and Graphic Fonts Including 8 Programmable RAM Fonts and 248 ROM Fonts
- Two Selectable Resolutions: 320 (CGA) and 640 (VGA) Dots/Line
- Wide Operating Frequency Range for High End Monitor: max. 120KHz
- Fully Programmable Character Array of 15 Rows by 30 Columns
- True 16-Color Selection for Windows
- Fancy Fade-In/Fade-Out Effects
- 8-Color Selection for Characters with Color Intensity Attribute on Each Row
- Auto Height Scaling to Keep Constant Height Independent of Display Modes
- Four Programmable Background Windows with Overlapping Capability
- Shadowing on Windows with Programmable Shadow Width/Height
- Character Bordering or Shadowing
- Character/Symbol Blinking Function
- Programmable Vertical Height of Character to Meet Multi-Sync Requirement
- Programmable Vertical and Horizontal Positioning for Display Centre
- Double Character Height and Double Character Width
- Internal PLL Generates a Wide-Ranged System Clock (76.8 MHz)
- M_BUS (IIC) Interface with Address \$7A

MC141549P2

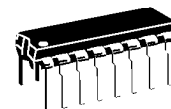

P SUFFIX
 PLASTIC PACKAGE

ORDERING INFORMATION

MC141549P2 Plastic Dip

PIN ASSIGNMENT

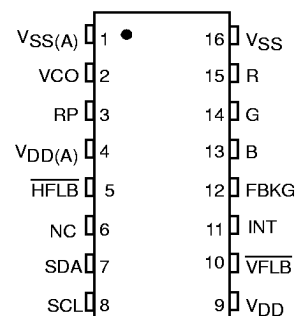

This document contains information on a product under development. Motorola reserves the right to change or discontinue this product without notice.



BLOCK DIAGRAM

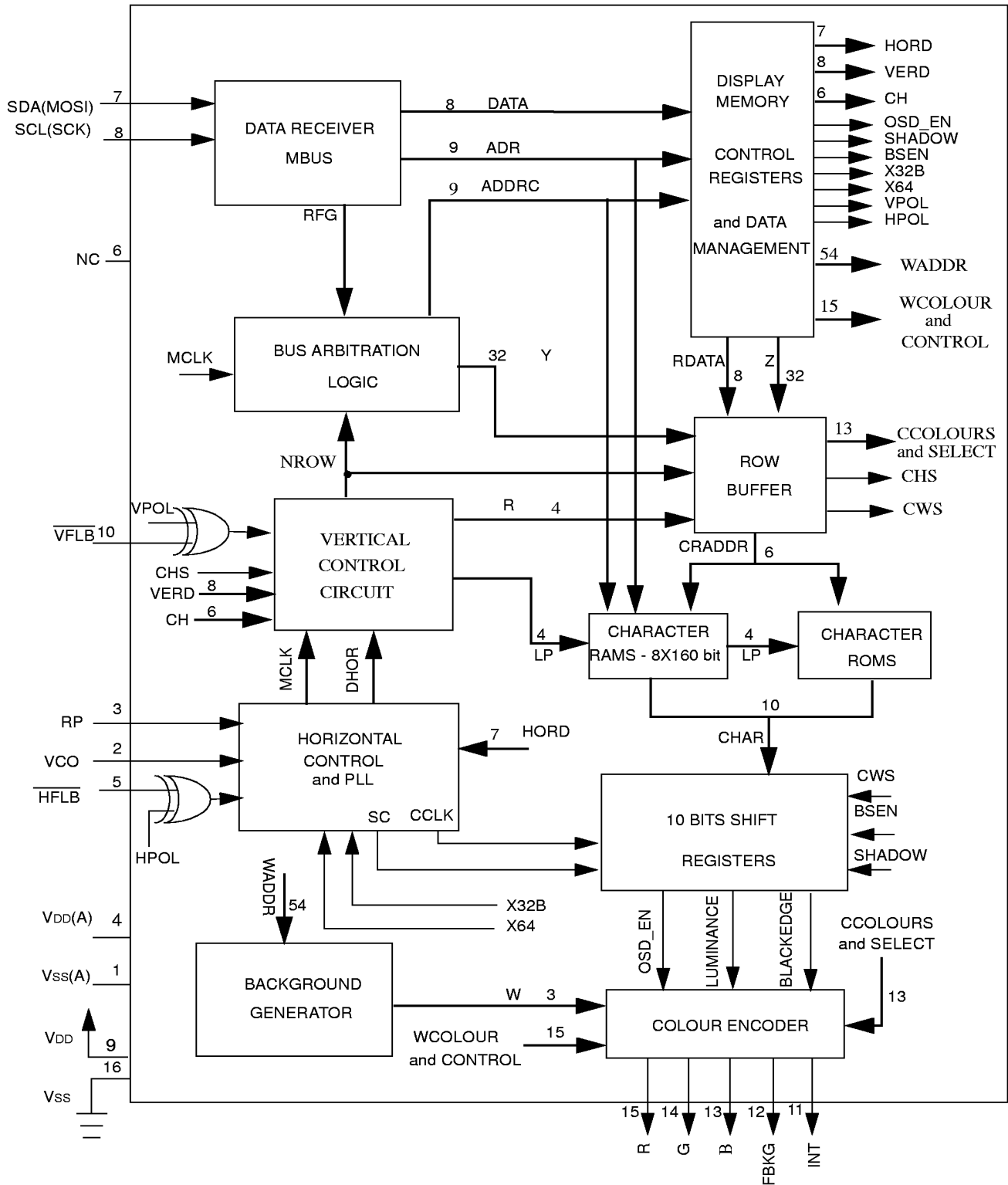

ABSOLUTE MAXIMUM RATINGS Voltage Referenced to V_{SS}

Symbol	Characteristic	Value	Unit
V_{DD}	Supply Voltage	- 0.3 to + 7.0	V
V_{in}	Input Voltage	$V_{SS} - 0.3$ to $V_{DD} + 0.3$	V
I_d	Current Drain per Pin Excluding V_{DD} and V_{SS}	25	mA
T_a	Operating Temperature Range	0 to 85	°C
T_{stg}	Storage Temperature Range	- 65 to + 150	°C

This device contains protection circuitry to guard against damage due to high static voltages or electric fields. However, precautions must be taken to avoid applications of any voltage higher than maximum rated voltages to this high-impedance circuit. For proper operation, V_{in} and V_{out} should be constrained to the range $V_{SS} \leq (V_{in}$ or $V_{out}) \leq V_{DD}$.

Unused inputs must always be tied to an appropriate logic voltage level (e.g., either V_{SS} or V_{DD}). Unused outputs must be left open.

NOTE: Maximum Ratings are those values beyond which damage to the device may occur. Functional operation should be restricted to the limits in the Electrical Characteristics tables or Pin Description section.

AC ELECTRICAL CHARACTERISTICS ($V_{DD}/V_{DD(A)} = 5.0$ V, $V_{SS}/V_{SS(A)} = 0$ V, $T_A = 25$ C, Voltage Referenced to V_{SS})

Symbol	Characteristic	Min	Typ	Max	Unit
t_r	Output Signal (R, G, B, FBKG and INT) $C_{load} = 8$ pF	—	—	6	ns
t_f		—	—	6	ns
f_{HFLB}	HFLB Input Frequency	—	—	120K	Hz

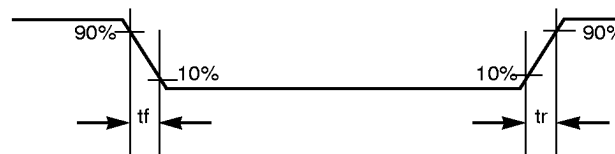

Figure 1. Switching Characteristics

DC CHARACTERISTICS $V_{DD}/V_{DD(A)} = 5.0\text{ V} \pm 10\%$, $V_{SS}/V_{SS(A)} = 0\text{ V}$, $T_A = 25^\circ\text{C}$, Voltage Referenced to V_{SS}

Symbol	Characteristic	Min	Typ	Max	Unit
V_{OH}	High Level Output Voltage $I_{out} = -5\text{ mA}$	$V_{DD} - 0.8$	—	—	V
V_{OL}	Low Level Output Voltage $I_{out} = 5\text{ mA}$	—	—	$V_{SS} + 0.4$	V
V_{IL} V_{IH}	Digital Input Voltage (Not Including SDA and SCL) Logic Low Logic High	— $0.7 V_{DD}$	— —	$0.3 V_{DD}$ —	V V
V_{IL} V_{IH}	Input Voltage of Pin SDA and SCL in M_BUS Mode Logic Low Logic High	— $0.7 V_{DD}$	— —	$0.3 V_{DD}$ —	V V
I_{II}	High-Z Leakage Current (R, G, B and FBKG)	-10	—	+10	μA
I_{II}	Input Current (Not Including RP, VCO, R, G, B, FBKG and INT)	-10	—	+10	μA
I_{DD}	Supply Current (No Load on Any Output)	—	+15	+20	mA

PIN DESCRIPTION

VSS(A) (Pin 1)

This pin provides the signal ground to the PLL circuitry. Analog ground for PLL is separated from digital ground for optimal performance. Please refer to Application Diagram.

VCO (Pin 2)

A dc control voltage input to regulate an internal oscillator frequency. See the Application Diagram for the application values used.

RP (Pin 3)

An external RC network is used to bias an internal VCO to resonate at the specific dot frequency. The maximum voltage at Pin 3 should not exceed 3.5 V at any condition. See the Application Diagram for the application values used.

VDD(A) (Pin 4)

A positive 5 V dc supply for PLL circuitry. Analog power for PLL is separated from digital power for optimal performance.

HFLB (Pin 5)

This pin inputs a negative polarity horizontal synchronize signal pulse to phase lock into an internal system clock generated by the on-chip VCO circuit.

NC (Pin 6)

No connection.

SDA (Pin 7)

Data and control message are being transmitted to this chip from a host MCU, via the serial M_BUS bus systems. With this protocol, this wire is configured as a uni-directional data

line. (Detailed description of the protocols will be discussed in the M_BUS section).

SCL (Pin 8)

A separate synchronizing clock input from the transmitter is required for either protocol. Data is read at the rising edge of each clock signal.

VDD (Pin 9)

This is the power pin for the digital logic of the chip.

VFLB (Pin 10)

Similar to Pin 5, this pin inputs a negative polarity of vertical synchronize signal to synchronize the vertical control circuit.

INT (Pin 11)

This output pin is used to indicate the color intensity. If the intensity control bits are set in the row attribute registers or window control registers, this pin will output a logic high while displaying the specified windows or the characters on the associated rows. Otherwise, it will keep in low state. Please refer to Figure 15 for detail timing chart. Thus, 16-color selection is achievable by combining this intensity pin with R/G/B outputs. On the other hand, this color intensity information could be reflected on the R/G/B pins by asserting tri-state instead of logic high if 3_S bit is set to 1. Refer to the "REGISTERS" for more information.

FBKG (Pin 12)

This pin will output a logic high while displaying characters or windows when FBKGC bit in frame control register is 0, and output a logic high only while displaying characters when FBKGC bit is 1. It is defaulted to high impedance state after power on, or when there is no output. An external 10 k Ω resis-

tor pulled low is recommended to avoid level toggling caused by hand effect when there is no output.

B,G,R (Pin 13, 14, 15)

SMOSD2 color outputs in CMOS level to the host monitor. These three signals are open drain outputs if 3_S bit is set and the color intensity is inactive. Otherwise, they are active high push-pull outputs. See "REGISTERS" for more information. These pins are in high impedance state after power on.

VSS (Pin 16)

This is the ground pin for the digital logic of the chip.

SYSTEM DESCRIPTION

MC141549P2 is a full screen memory architecture. Refresh is done by the built-in circuitry after a screenful of display data has been loaded in through the serial bus. Only changes to the display data need to be input afterward.

Serial data, which includes screen mapping address, display information, and control messages, are being transmitted by M_BUS.

Data is first received and saved in the MEMORY MANAGEMENT CIRCUIT in the Block Diagram. Meanwhile, the SMOSD2 is continuously retrieving the data and putting it into a ROW BUFFER for display and refreshing, row after row. During this storing and retrieving cycle, a BUS ARBITRATION LOGIC will patrol the internal traffic, to make sure that no crashes occur between the slower serial bus receiver and fast 'screen-refresh' circuitry. After the full screen display data is received through the serial communication interface, the link can be terminated if change on display is not required.

The bottom half of the Block Diagram constitutes the heart of this entire system. It performs all the SMOSD2 functions such as programmable vertical length (from 16 lines to 63 lines), display clock generation (which is phase locked to the incoming horizontal sync signal at Pin 5 HFLB), bordering or shadowing, and multiple windowing.

COMMUNICATION PROTOCOLS

BUS Operation

The operating clock for M_BUS derives from system dot clock. Internal PLL is using to generate the dot clock base on the HFLB input frequency where the dot clock is equal to $320/640 \times \text{HFLB}$ in 320/640 modes respectively. In order to have stable operation of M_BUS bus in the OSD and meet below specifications, HFLB signal must be presented and the PLL locks to HFLB properly. Refer to Application Diagram for PLL bias circuit.

M_BUS Serial Communication

This is a two-wire serial communication link that is fully compatible with the IIC bus system. It consists of SDA bidirectional data line and SCL clock input line. Data is sent from a transmitter (master), to a receiver (slave) via the SDA line, and is synchronized with a transmitter clock on the SCL line at the receiving end. The maximum data rate is limited to 100 kbps. The default chip address is \$7A.

Operating Procedure

Figure 2 shows the M_BUS transmission format. The master initiates a transmission routine by generating a START

condition, followed by a slave address byte. Once the address is properly identified, the slave will respond with an ACKNOWLEDGE signal by pulling the SDA line LOW during the ninth SCL clock. Each data byte which then follows must be eight bits long, plus the ACKNOWLEDGE bit, to make up nine bits together. Appropriate row and column address information and display data can be downloaded sequentially in one of the three transmission formats described in DATA TRANSMISSION FORMATS SECTION. In the cases of no ACKNOWLEDGE or completion of data transfer, the master will generate a STOP condition to terminate the transmission routine. Note that the OSD_EN bit must be set after all the display information has been sent in order to activate the SMOSD2 circuitry of MC141549P2, so that the received information can then be displayed.

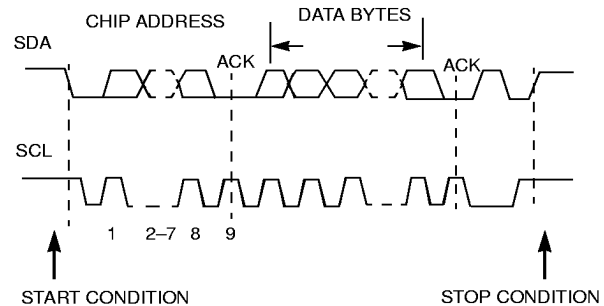

Figure 2. M_BUS Format

DATA TRANSMISSION FORMATS

After the proper identification by the receiving device, data train of arbitrary length is transmitted from the Master. As mentioned above, three register blocks, display registers, attribute/control registers and RAM fonts, need to be programmed before the proper operation. Basically, these three areas use the similar transmission protocol. Only two bits of the row/segment byte are used to distinguish the programming blocks.

There are three transmission formats, from (a) to (c) as stated below. The data train in each sequence consists of row/seg address (R), column/line address (C), and data informations (I). In format (a), each display information data have to be preceded with the corresponding row/seg address and column/line address. This format is particular suitable for updating small amount of data between different row. However, if the current information byte has the same row/seg address as the one before, format (b) is recommended. For a full screen pattern change which requires massive information update or during power up situation, most of the row/seg and column/line address on either (a) or (b) format will appear to be redundant. A more efficient data transmission format (c) should be applied. It sends the RAM starting row/seg and column/line addresses once only, and then treat all subsequent data as data information. The row/seg and column/line addresses will be automatically incremented internally for each information data from the starting location.

Based on the different programming areas, the detail transmission protocol is described below respectively.

(I) Display Register Programming

The data transmission formats are:

- (a) R -> C -> I -> R -> C -> I ->
- (b) R -> C -> I -> C -> I -> C -> I
- (c) R -> C -> I -> I -> I -> . . -> I_{dummy} -> I_{dummy} -> I -> I . .

NOTE: - R means row byte.
 - C means column byte.
 - I means data byte.
 - In format (c), two dummy data bytes(col 30, col 31) have to be inserted after the last data byte(col 29) at the end of each row, before the first data byte of the next row.

To differentiate the display row address from attribute/RAM fonts area when transferring data, the most significant three bits are set to '100' to represent display row address, while '00X' for column address used in format (a) or (b) and '01X' for column address used in format (c). There is some limitation on using mix-formats during a single transmission. It is permissible to change the format from (a) to (b), or from (a) to (c), or from (b) to (a), but not from (c) back to (a) or (b).

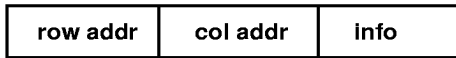

Figure 3. Data Packet for Display Data

(II) Attribute/Control Register Programming

The data transmission formats are similar with that in display data programming:

- (a) R -> C -> I -> R -> C -> I ->
- (b) R -> C -> I -> C -> I -> C -> I
- (c) R -> C -> I -> I -> I -> . . -> I_{row attr.} -> I_{dummy} -> I -> I . .

NOTE: - R means row byte.
 - C means column byte.
 - I means data byte.
 - In format (c), one dummy data byte(col 31) has to be inserted after the row attribute data byte (col 30) at end of each row, before the first character attribute data byte of the next row.

To differentiate the row address for attribute/control registers from display area when transferring data, the most significant three bits are set to '101' to represent the row address of the attribute/control registers, while '00X' for column address used in format (a) or (b) and '01X' for column address used in format (c). There is some limitation on using mix-formats during a single transmission. It is permissible to change the format from (a) to (b), or from (a) to (c), or from (b) to (a), but not from (c) back to (a) or (b).



Figure 5. Data Packet for Attribute/Control Data

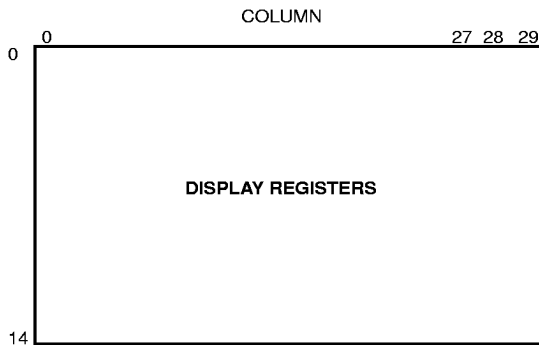

ADDRESS	BIT								FORMAT
	7	6	5	4	3	2	1	0	
ROW	1	0	0	X	D	D	D	D	a, b, c
COLUMN	0	0	X	D	D	D	D	D	a, b
COLUMN	0	1	X	D	D	D	D	D	c

X: don't care D: valid data

Figure 4. Address Bit Patterns for Display Data

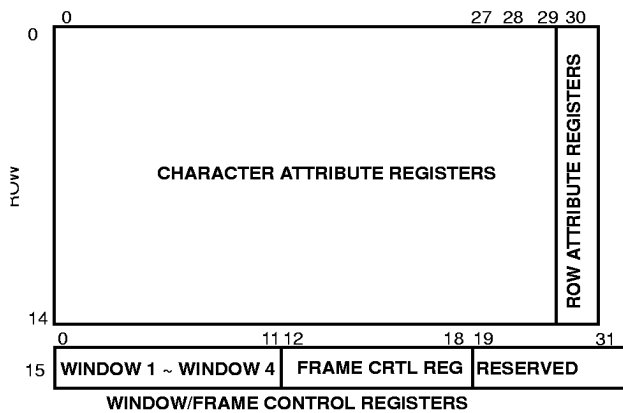

	ADDRESS		BIT							FORMAT
	7	6	5	4	3	2	1	0		
ROW	1	0	1	X	D	D	D	D	a, b, c	
COLUMN	0	0	X	D	D	D	D	D	a, b	
COLUMN	0	1	X	D	D	D	D	D	c	

X: don't care D: valid data

Figure 6. Address Bit Patterns for Attribute/Control Data

(III) RAM Fonts Programming

Basically, the transmission format is very similar with that for display RAM or control registers. The major difference is to replace the row and column address with segment address and line address respectively. There are also three transmission formats, from (a) to (c) as stated below. The data train in each sequence consists of segment address (S), line address (L), and font informations (I), as shown in Figure 3. In format (a), each font information data have to be preceded with the corresponding segment address and line address. This format is particular suitable for updating small portion of font pattern. However, if the current information byte has the same segment address as the one before, format (b) is recommended. For a new font pattern change which requires massive information update or during power up situation, most of the segment and column address on either (a) or (b) format will appear to be redundant. A more efficient data transmission format (c) should be applied. It sends the character RAM starting segment and line addresses once only, and then treat all subsequent data as font information. The segment and line addresses will be automatically incremented internally for each RAM font data from the starting location.

- The transmission formats are shown below:
- (a) S -> L -> I -> S -> L -> I ->
 - (b) S -> L -> I -> L -> I -> L -> I ->
 - (c) S -> L -> I -> I -> I ->

NOTE: S means segment byte.

L means line byte.
I means data byte.

To differentiate the segment address from row and line address when transferring data, the bit 7 (MSB) and bit 6 are set to '11' to represent segment address, while '00' for line address used in format (a) or (b) and '01' for line address used in format (c). There is some limitation on using mix-formats during a single transmission. It is permissible to change the format from (a) to (b), or from (a) to (c), or from (b) to (a), but not from (c) back to (a) or (b).

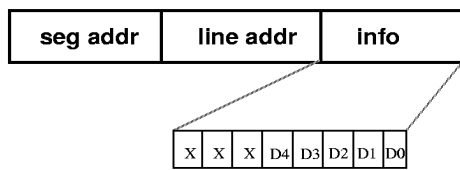

NOTE: X means don't care bit and D means valid data bit.

Figure 7. Data Packet for RAM Fonts

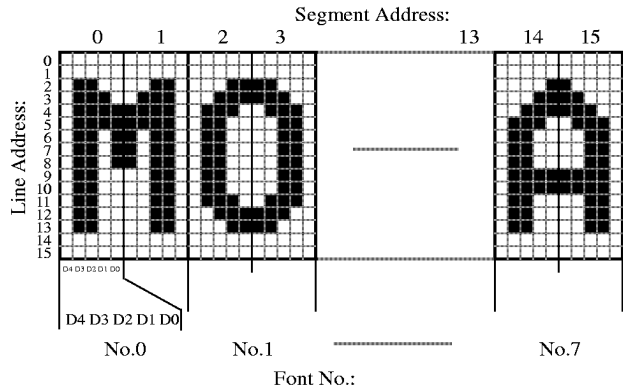

	ADDRESS		BIT							FORMAT
	7	6	5	4	3	2	1	0		
SEG	1	1	X	X	D	D	D	D	a, b, c	
LINE	0	0	X	X	D	D	D	D	a, b	
LINE	0	1	X	X	D	D	D	D	c	

X: don't care D: valid data

Figure 8. Address Bit Patterns for RAM Fonts

MEMORY MANAGEMENT

All the internal programmable area can be divided into three parts including (1) Display Registers (2) Attribute/Control Registers and (3) Programmable RAM Fonts. Please refer to the following three figures for the corresponding memory map.

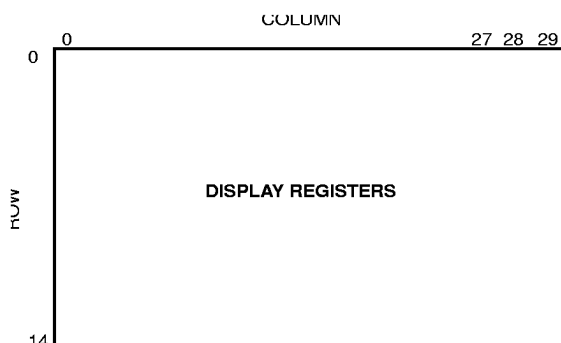

Figure 9. Memory Map of Display Registers

Internal display RAM are addressed with row and column (coln) number in sequence. As the display area is 15 rows by 30 columns, the related display registers are also 15 by 30. The space between row 0 and coln 0 to row 14 and coln 29 are called Display registers, with each contains a character/symbol address corresponding to display location on monitor screen. And each register is 8-bit wide to identify the selected character/symbol out of 256 RAM/ROM fonts.

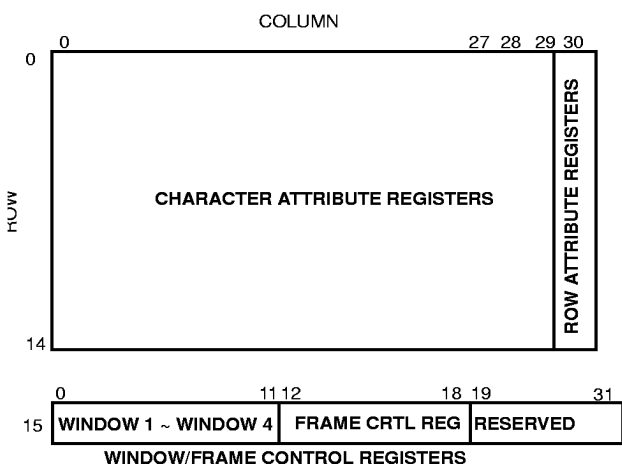

Figure 10. Memory Map of Attribute/Control Registers

Besides the font selection, there is 3-bit attribute associated with each symbol to identify its color. Because of 3-bit attribute, each character can select any color out of 8 independently on the same row. Every data row associate with one attribute register, which locate at coln 30 of their respective rows, to control the characters display format of that row such as the character blinking, color intensity, character double height and character double width function. In addition, other control registers are located at row 15 such as window control and frame function control registers. Three window control registers for each of four windows together with seven frame control registers occupy the first 19 columns of row 15 space. These control registers will be described on the "REGISTERS" section.

User should handle the internal display RAM address location with care especially for those rows with double length alphanumeric symbols. For example, if row n is destined to be double height on the memory map, the data displayed on screen row n and n+1 will be represented by the data contained in the memory address of row n only. The data of next row n+1 on the memory map will appear on the screen of n+2 and n+3 row space and so on. Hence, it is not necessary to throw in a row of blank data to compensate for the double row action. User needs to take care of excessive row of data in memory in order to avoid over running the limited number of row space on the screen.

There is difference for rows with double width alphanumeric symbols. Only the data contained in the even numbered columns of memory map will be shown, the odd numbered columns will be ignored and not disclosed.

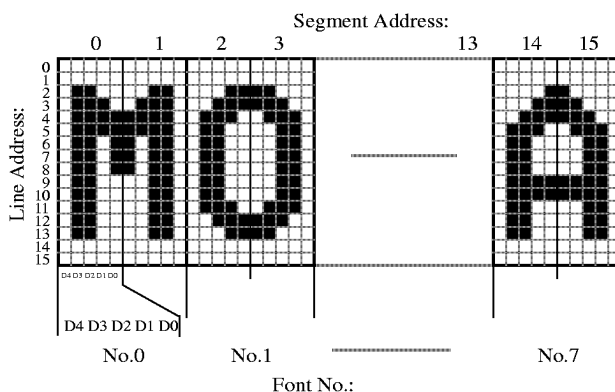

Figure 11. Memory Map of Programmable RAM Fonts

Another programming area is the RAM fonts. Totally, 8 fonts are programmable in SMOSD2. The structure of 8 character RAM fonts are shown in Figure 12. They occupy the font number from 0 to 7 while ROM fonts 8 to 255. Because of the 10X16 dot matrix font, we decompose each font into 2 segments in horizontal direction and 16 lines in vertical direction. So, there are 5 dots needed to be defined for each specified segment-line location. This 5-bit data forms the lower 5 bits of the information data byte and the higher 3 bits are ignored. Because there are 16 segments (2 segments per font) and 16 lines, both the segment and line addresses are 4-bit wide.

REGISTERS

(I) Display Register

Display Register (Row 0~14, Coln 0~29)

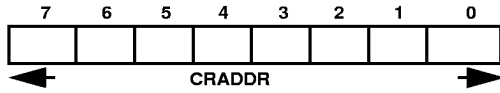

Bit 7-0 CRADDR - This eight bits address one of the 256 characters or symbols resided in the character RAM/ROM fonts.

(II) Attribute/Window/Control/Frame Registers

Character Attribute Register (Row 0~14, Coln 0~29)

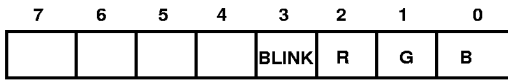

Bit 3 BLINK - The blinking effect will be active on the corresponding character if this bit is set to 1. The blinking frequency is approximately one time per second (1Hz) with fifty-fifty duty cycle at 80Hz vertical scan frequency.

Bit 2-0 These three bits are the color attribute to define the color of the associated character/symbol.

Row Attribute Register (Row 0~14, Coln 30)

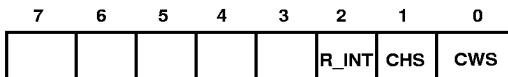

Bit 2 R_INT - Row intensity bit controls the color intensity of the displayed character/symbol on the corresponding row. Setting this bit to 1 means high intensity color and the INT pin will go high while displaying the characters of this row.

Bit 1 CHS - It determines the height of a display symbol. When this bit is set, the symbol is displayed in double height.

Bit 0 CWS - Similar to bit 1, character is displayed in double width, if this bit is set.

Window 1 Registers

Row 15 Coln 0

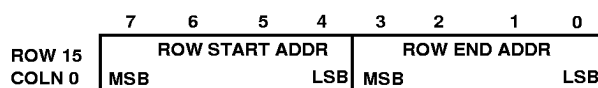

Row 15 Coln 1

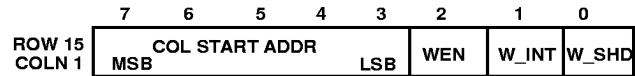

Bit 2 WEN - It enables the background window 1 generation if this bit is set.

Bit 1 W_INT - This additional color related bit provides the color intensity selection for window 1. If this bit is 0, INT pin will go low while displaying window 1. The default value is 1 to indicate high intensity. Video pre-amplifier or external R/G/B switch can make use of INT pin for windows's color intensity control.

Bit 0 W_SHD - Shadowing on window. Set this bit to activate the window 1 shadowing. When the window is active, the right M pixels and lower N horizontal scan lines will output black shadowing. The width/height of window shadow, number of M/N, is defined in the frame control registers located at row 15 column 16 and 17. See the following figure and the related frame control register for detail.

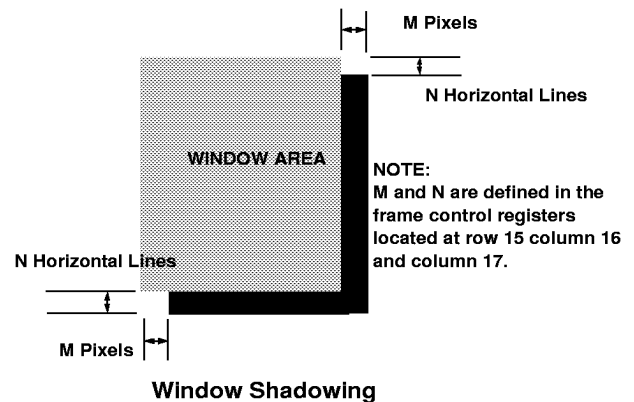

Row 15 Coln 2

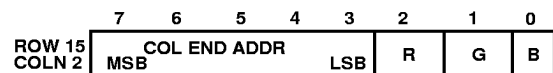

Bit 2-0 R, G and B - Controls the color of window 1. Window 1 registers occupy Column 0-2 of Row 15, Window 2 from Column 3-5, Window 3 from 6-8 and Window 4 from 9-11. Window 1 has the highest priority, and Window 4 the least. If window over-lapping occurs, the higher priority window will cover the lower one, and the higher priority color will take over on the overlap window area. If the start address is greater than the end address, this window will not be displayed.

Window 2 Registers

Row 15 Coln 3

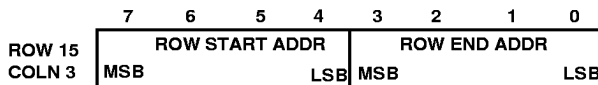

Row 15 Coln 4

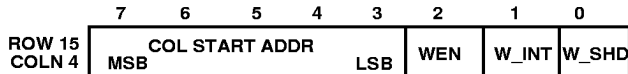

Bit 2 WEN - It enables the background window 2 generation if this bit is set.

Bit 1 W_INT - This additional color related bit provides the color intensity selection for window 2. If this bit is 0, INT pin will go low while displaying window 2. The default value is 1 to indicate high intensity. .Video pre-amplifier or external R/G/B switch can make use of INT pin for windows's color intensity control.

Bit 0 W_SHD - Shadowing on window. Set this bit to activate the window 2 shadowing.

Row 15 Coln 5

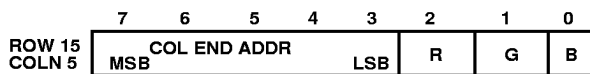

Bit 2-0 R, G and B - Controls the color of window 2. Window 1 registers occupy Column 0-2 of Row 15, Window 2 from Column 3-5, Window 3 from 6-8 and Window 4 from 9-11. Window 1 has the highest priority, and Window 4 the least. If window over-lapping occurs, the higher priority window will cover the lower one, and the higher priority color will take over on the overlap window area. If the start address is greater than the end address, this window will not be displayed.

Window 3 Registers

Row 15 Coln 6

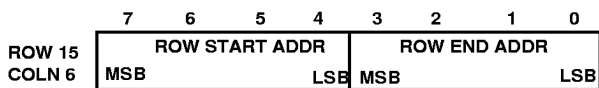

Row 15 Coln 7

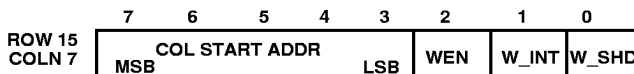

Bit 2 WEN - It enables the background window 3 generation if this bit is set.

Bit 1 W_INT - This additional color related bit provides the color intensity selection for window 3. If this bit is 0, INT pin will go low while displaying window 3. The default value is

1 to indicate high intensity. .Video pre-amplifier or external R/G/B switch can make use of INT pin for windows's color intensity control.

Bit 0 W_SHD - Shadowing on window. Set this bit to activate the window 3 shadowing.

Row 15 Coln 8

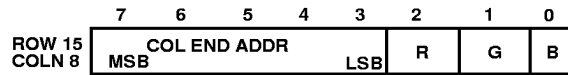

Bit 2-0 R, G and B - Controls the color of window 3. Window 1 registers occupy Column 0-2 of Row 15, Window 2 from Column 3-5, Window 3 from 6-8 and Window 4 from 9-11. Window 1 has the highest priority, and Window 4 the least. If window over-lapping occurs, the higher priority window will cover the lower one, and the higher priority color will take over on the overlap window area. If the start address is greater than the end address, this window will not be displayed.

Window 4 Registers

Row 15 Coln 9

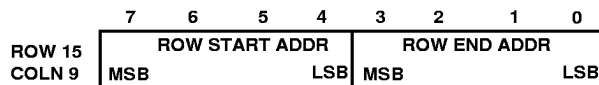

Row 15 Coln 10

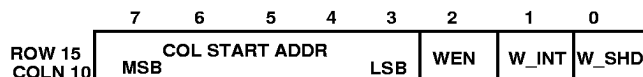

Bit 2 WEN - It enables the background window 4 generation if this bit is set.

Bit 1 W_INT - This additional color related bit provides the color intensity selection for window 4. If this bit is 0, INT pin will go low while displaying window 4. The default value is 1 to indicate high intensity. .Video pre-amplifier or external R/G/B switch can make use of INT pin for windows's color intensity control.

Bit 0 W_SHD - Shadowing on window. Set this bit to activate the window 4 shadowing.

Row 15 Coln 11

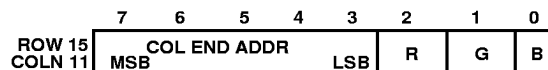

Bit 2-0 R, G and B - Controls the color of window 4. Window 1 registers occupy Column 0-2 of Row 15, Window 2 from Column 3-5, Window 3 from 6-8 and Window 4 from 9-11. Window 1 has the highest priority, and Window 4 the least. If window over-lapping occurs, the higher priority win-

low will cover the lower one, and the higher priority color will take over on the overlap window area. If the start address is greater than the end address, this window will not be displayed.

Vertical Delay Control Register Row 15 Coln 12

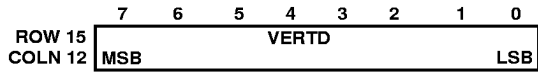

Bit 7-0 VERTD - These 8 bits define the vertical starting position. Total 256 steps, with an increment of four horizontal lines per step for each field. Its value can't be zero anytime. The default value of it is 4.

Horizontal Delay Control Register Row 15 Coln 13

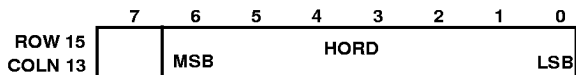

Bit 6-0 HORD - Horizontal starting position for character display. 7 bits give a total of 128 steps and each increment represents five dots movement shift to the right on the monitor screen. Its value cannot be zero anytime. The default value of it is 15.

Character Height Control Register Row 15 Coln 14

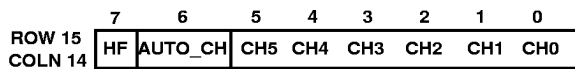

Bit 7 HF - High Frequency Bit. If the incoming H sync signal is higher than 60 KHz, set this bit to 1. This bit controls gain of internal VCO so that PLL can work for whole range from up to 120KHz.

Bit 6 AUTO_CH - Auto Character Height Adjustment. If this bit is set, the character height will be controlled internally to keep the fixed ratio in the vertical direction and independent of the display modes. The ratio of character height to the screen is roughly 1/24 and 1/48 for 320/640 resolution modes respectively. In the meantime, CH5-CH0 are ignored.

Bit 5-0 CH5-CH0 - This six bits will determine the displayed character height if AUTO_CH bit is cleared. It is possible to have a proper character height by setting a value greater than or equal to 16 on different horizontal frequency monitor. Setting a value below 16 will not have a predictable result. Figure 13 illustrates how this chip expand the built-in character font to the desired height.

Frame Control Register Row 15 Coln 15

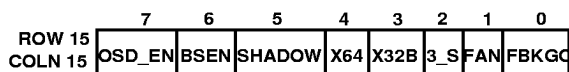

Bit 7 OSD_EN - OSD circuit is activated when this bit is set.

Bit 6 BSEN - It enables the character bordering or shadowing function when this bit is set.

Bit 5 SHADOW - Character with black-edge shadowing is selected if this bit is set, otherwise bordering prevails.

Bit 4-3 X64, X32B - It determines the number of dots per horizontal line. There are 320 dots per horizontal line if bit X32B is clear and this is also the default power on state. Otherwise, it will be 640 dots per horizontal sync line when both bit X32 and bit X64 are set to 1. The setting of X64=0 and X32=1 is not allowed; otherwise, unpredictable result may occur. Please refer to the Table 1 for details.

Table 1. Resolution Setting

(X64, X32B)	(0, 0)	(1, 0)	(1, 1)	(0, 1)
Dots / Line	320	320	640	not allowed
Resolution	CGA	CGA	VGA	allowed

Bit 2 3_S - By setting this bit to 1, R/G/B could output high impedance state if the intensity attribute of characters or windows is set to 0. It means the corresponding R/G/B output will go high impedance instead of driving-high while displaying the low intensity characters or windows. After power on, this bit is reset and the R/G/B are push-pull outputs initially.

Bit 1 FAN - It enables the fan-in/fan-out functions when OSD is turned on from off state or vice versa. If this bit is set, it roughly takes about one second to fully display the whole menu. It also takes 1 second to disappear completely.

Bit 0 FBKGC - It determines the configuration of FBKG output pin. When it is clear, FBKG pin outputs high during displaying characters or windows. Otherwise, FBKG pin outputs high only during displaying characters.

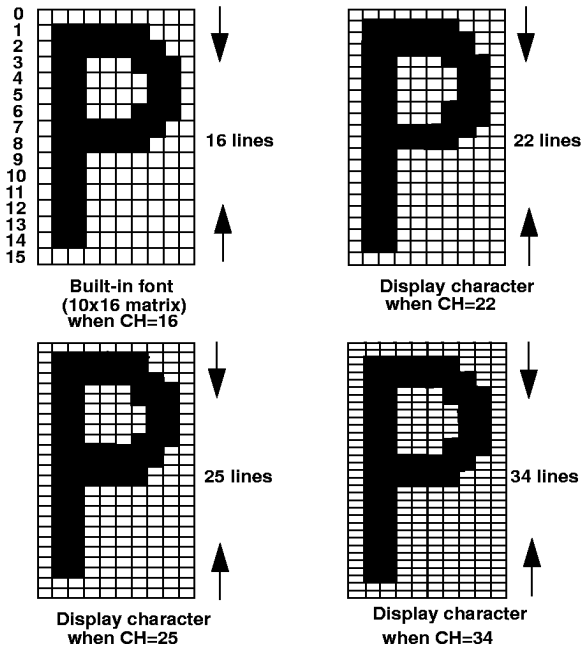
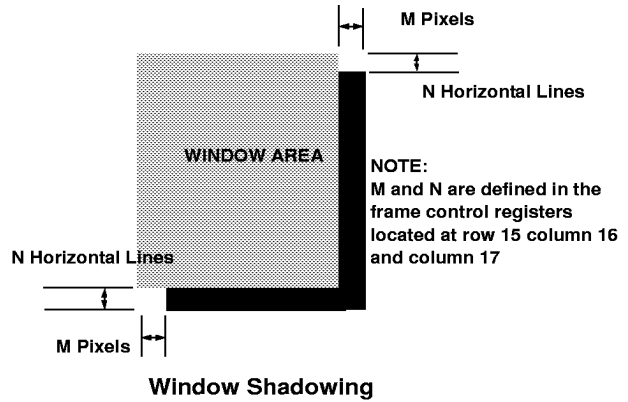

Figure 12. Variable Character Height



Frame Control Register Row 15 Coln 16

	7	6	5	4	3	2	1	0
ROW 15 COLN 16	WW41	WW40	WW31	WW30	WW21	WW20	WW11	WW10

Bit 7-6 WW41, WW40 - It determines the shadow width of the window 4 when the window shadowing function is activated. Please refer to the following table for more details where M is the actual pixel number of the shadowing.

Table 2. Shadow Width Setting

(WW41, WW40)	(0, 0)	(0, 1)	(1, 0)	(1, 1)
Shadow Width M (unit in Pixel)	2	4	6	8

Bit 5-4 WW31, WW30 - Similarly as WW41, WW40, these two bits determine the shadow width of the window 3 when the window shadowing function is activated.

Bit 3-2 WW21, WW20 - Similarly as WW41, WW40, these two bits determine the shadow width of the window 2 when the window shadowing function is activated.

Bit 1-0 WW11, WW10 - Similarly as WW41, WW40, these two bits determine the shadow width of the window 1 when the window shadowing function is activated

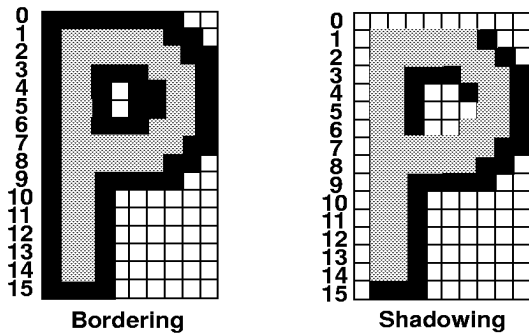

Figure 13. Character Bordering and Shadowing

Frame Control Register Row 15 Coln 17

	7	6	5	4	3	2	1	0
ROW 15 COLN 17	WH41	WH40	WH31	WH30	WH21	WH20	WH11	WH10

Bit 7-6 WH41, WH40 - It determines the shadow height of the window 4 when the window shadowing function is activated. Please refer to the following table for more details where N is the actual line number of the shadowing.

Table 3. Shadow Width Setting

(WH41, WH40)	(0, 0)	(0, 1)	(1, 0)	(1, 1)
Shadow Height N (unit in Line)	2	4	6	8

Bit 5-4 WH31, WH30 - Similarly as WH41, WH40, these two bits determine the shadow height of the window 3 when the window shadowing function is activated.

Bit 3-2 WH21, WH20 - Similarly as WH41, WH40, these two bits determine the shadow height of the window 2 when the window shadowing function is activated.

Bit 1-0 WH11, WH10 - Similarly as WH41, WH40, these two bits determine the shadow height of the window 1 when the window shadowing function is activated.

Frame Control Register Row 15 Coln 18

	7	6	5	4	3	2	1	0
ROW 15 COLN 18						TRIC	HPOL	VPOL

Bit 2 TRIC - Tri-state Control. This bit is used to control the driving state of output pins, R, G, B and FBKG when the OSD is disabled. After power on, this bit is reset and R, G, B and FBKG are in high impedance state while OSD being disabled. If it is set by MCU, these four output pins will drive low while OSD being in disabled state. Basically, the setting is dependent on the requirement of the external application circuit.

Bit 1 HPOL - This bit selects the polarity of the incoming horizontal sync signal (HFLB). If it is negative polarity, clear this bit. Otherwise, set this bit to 1 to represent the positive H sync signal. After power on, this bit is cleared.

Bit 0 VPOL - This bit selects the polarity of the incoming vertical sync signal (VFLB). If it is negative polarity, clear this bit. Otherwise, set this bit to 1 to represent the positive V sync signal. After power on, this bit is cleared.

• **NOTE: The registers located at column 19 of row 15 are reserved for the chip testing. In normal operation, they should not be programmed anytime.**

Frame Format and Timing

Figure 14 illustrates the positions of all display characters on the screen relative to the leading edge of horizontal and vertical flyback signals. The shaded area indicates the area not interfered by the display characters. Notice that there are two components in the equations stated in Figure 14 for horizontal and vertical delays: fixed delays from the leading edge of HFLB and VFLB signals, regardless of the values of HORD and VERTD: (47 dots + phase detection pulse width) and one H scan line for horizontal and vertical delays, respectively; variable delays determined by the values of HORD and VERTD. Refer to Frame Control Registers COLN 9 and 10 for the definitions of VERTD and HORD. Phase detection pulse width is a function of the external charge-up resistor, which is the 1MΩ resistor in a series with 5.6 kΩ to VCO pin in the

Application Diagram. Dot frequency is determined by the equation: H Freq. x 320 if the bit X32B is clear and H Freq. x 640 if both bit X32B and bit X64 are set to 1. For example, dot frequency is 10.24 MHz if H freq is 32 KHz while bit X32B is 0. If X32B is 1 and bit X64 is also 1, the dot frequency will be 20.48 MHz (double of the original one).

When double character width is selected for a row, only the even-numbered characters will be displayed, as shown in row 2. Notice that the total number of horizontal scan lines in the display frame is variable, depending on the chosen character height of each row. Care should be taken while configuring each row character height so that the last horizontal scan line in the display frame always comes out before the leading edge of VFLB of next frame to avoid wrapping display characters of the last few rows in the current frame into the next frame. The number of display dots in a horizontal scan line is always fixed at 300, regardless of row character width and the setting of bit X32B and X64.

Although there are 30 character display registers that can be programmed for each row, not every programmed character can be shown on the screen in 320 dots resolution. Usually, only 24 characters can be shown in this resolution at most. This is induced by the retrace time that is required to retrace the H scan line. In 640 dots resolution, 30 characters can be displayed on the screen totally if the horizontal delay register is set properly.

Figure 15 illustrates the timing of all output signals as a function of window and fast blanking features. Line 3 of all three characters is used to illustrate the timing signals. The shaded area depicts the window area. Both the left hand side and right hand side characters are embodied in a window with only one difference: FBKGC bit. The middle character does not have a window as its background. Timing of signal FBKGC depends on the configuration of FBKGC bit. The configuration of FBKGC bits affects only FBKGC signal timing. Waveform 'R, G or B', which is the actual waveform at R, G, or B pin, is the logical OR of waveform 'character R, G or B' and waveform 'window R, G or B'. 'Character R, G, or B' and 'window R, G, or B' are internal signals for illustration purpose only.

ROM CONTENT

Figures 16 – 19 show the ROM content of MC141549P2.

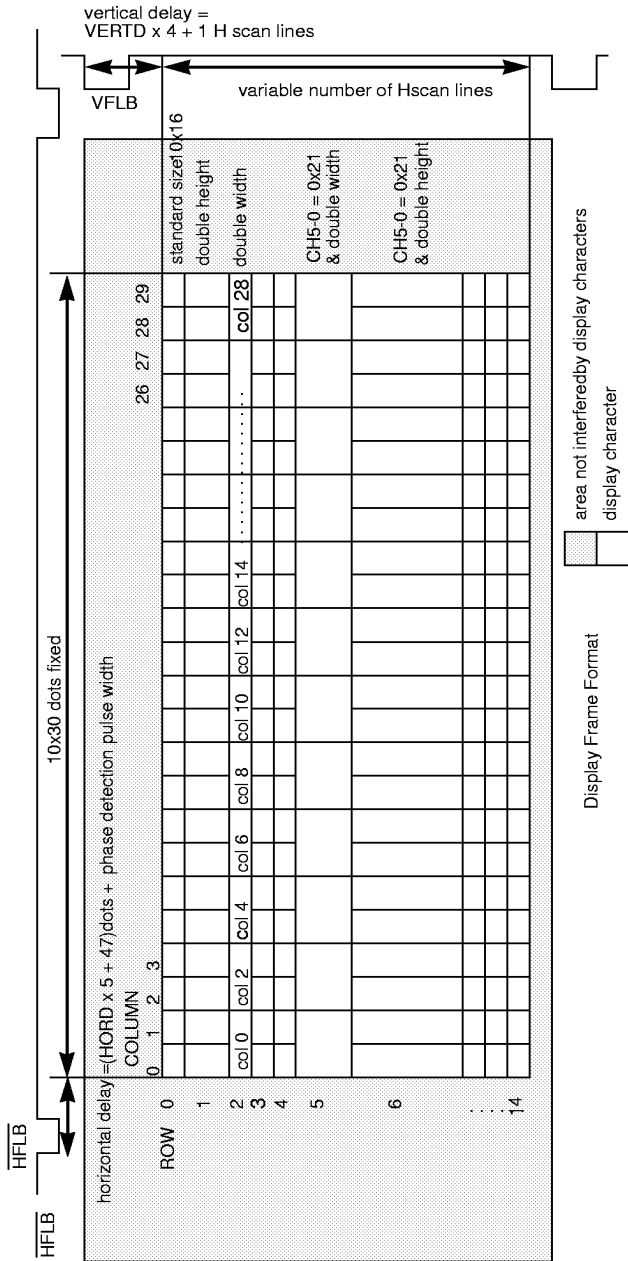

Figure 14. Display Frame Format

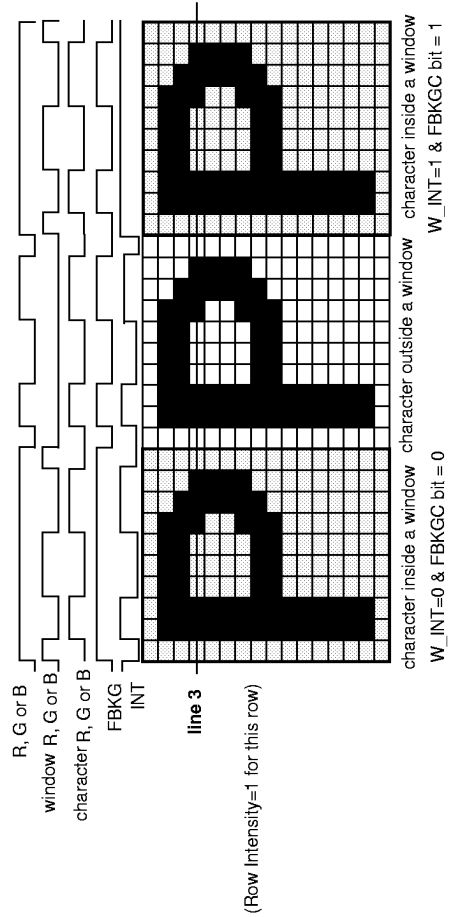

Figure 15. Timing of Output Signals

Timing of Output Signals as a Function of Window, FBKGC bit and Row Intensity Features

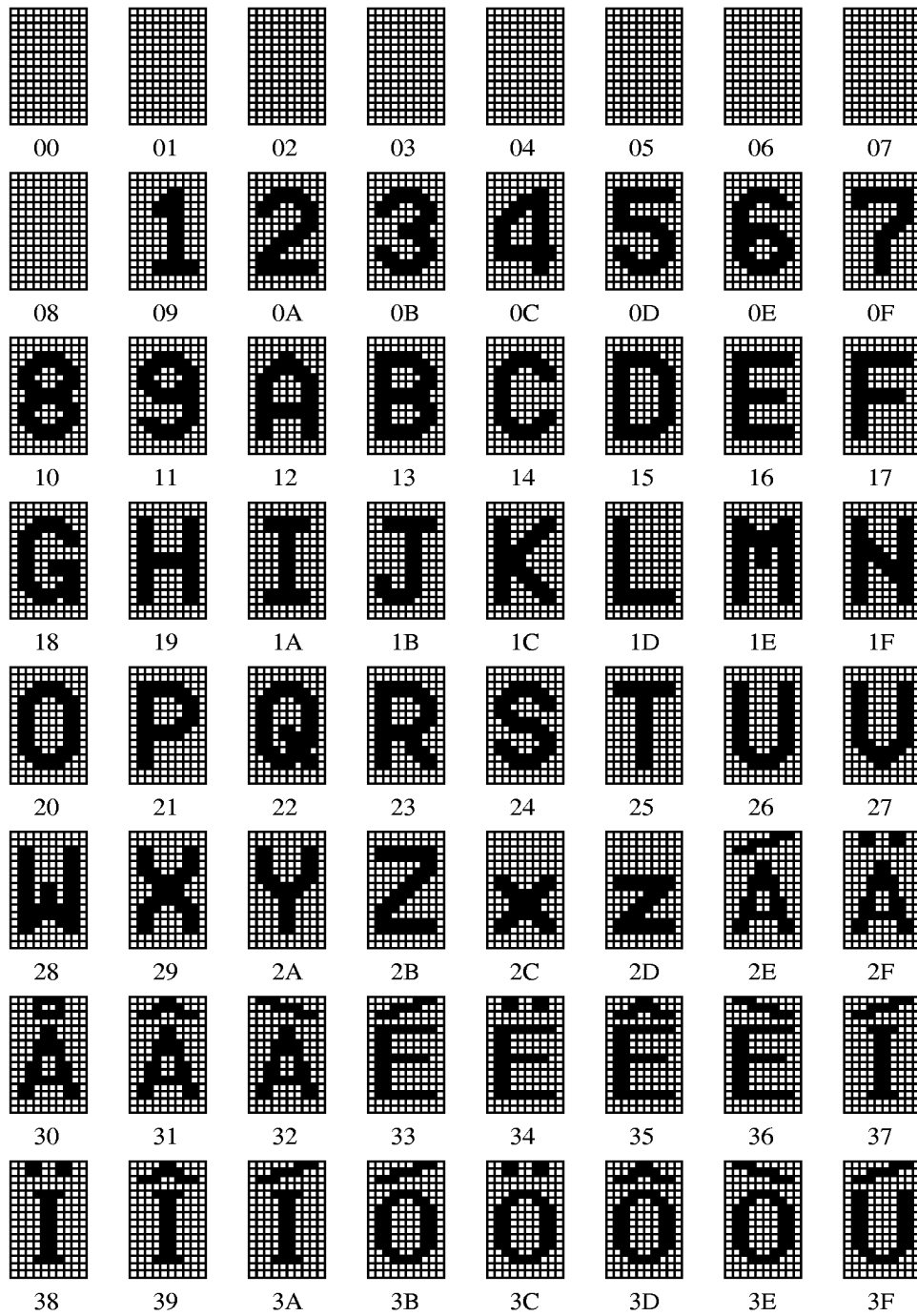

Figure 16. ROM Address (\$08 – \$3F)

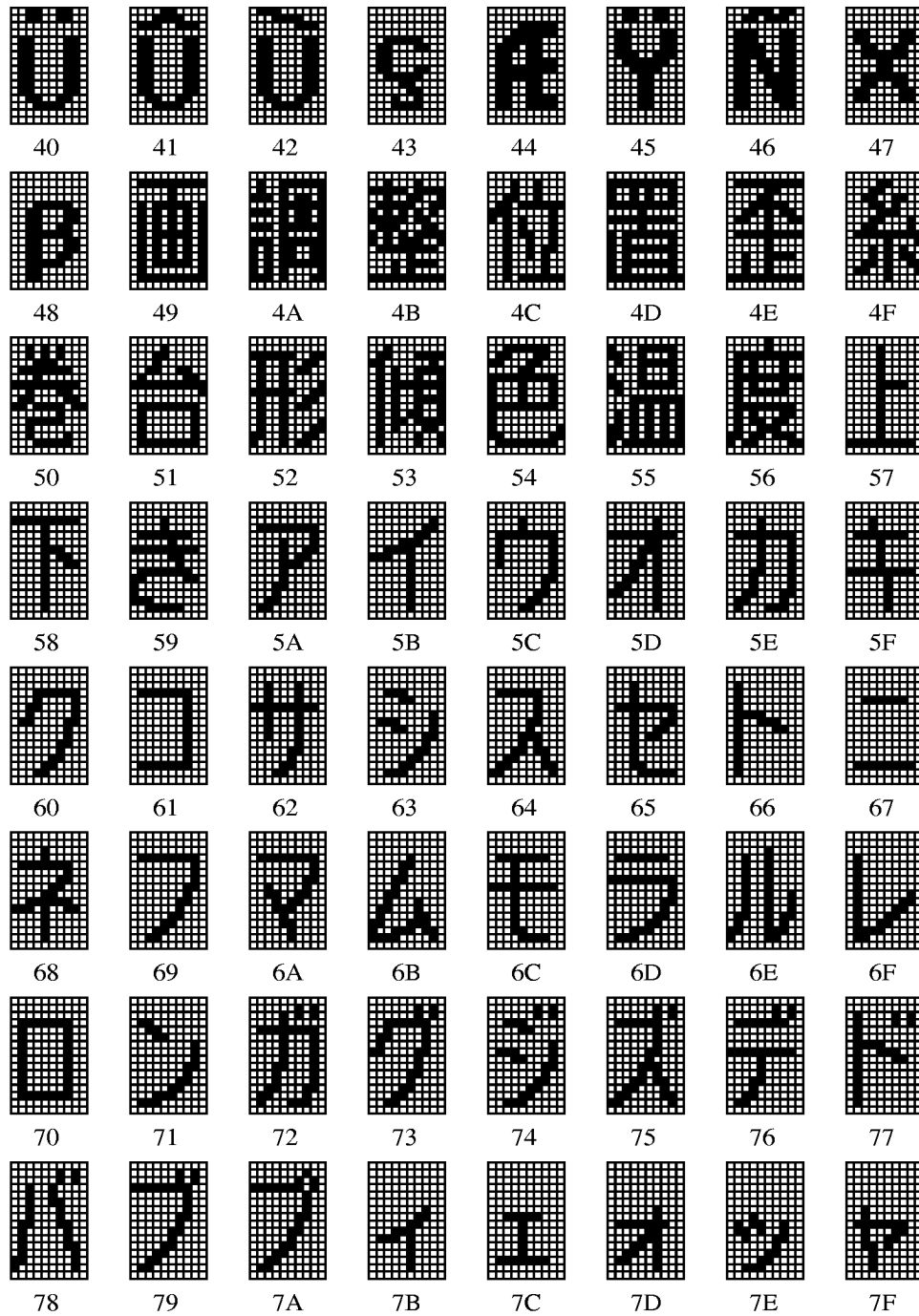

Figure 17. ROM Address (\$40 – \$7F)

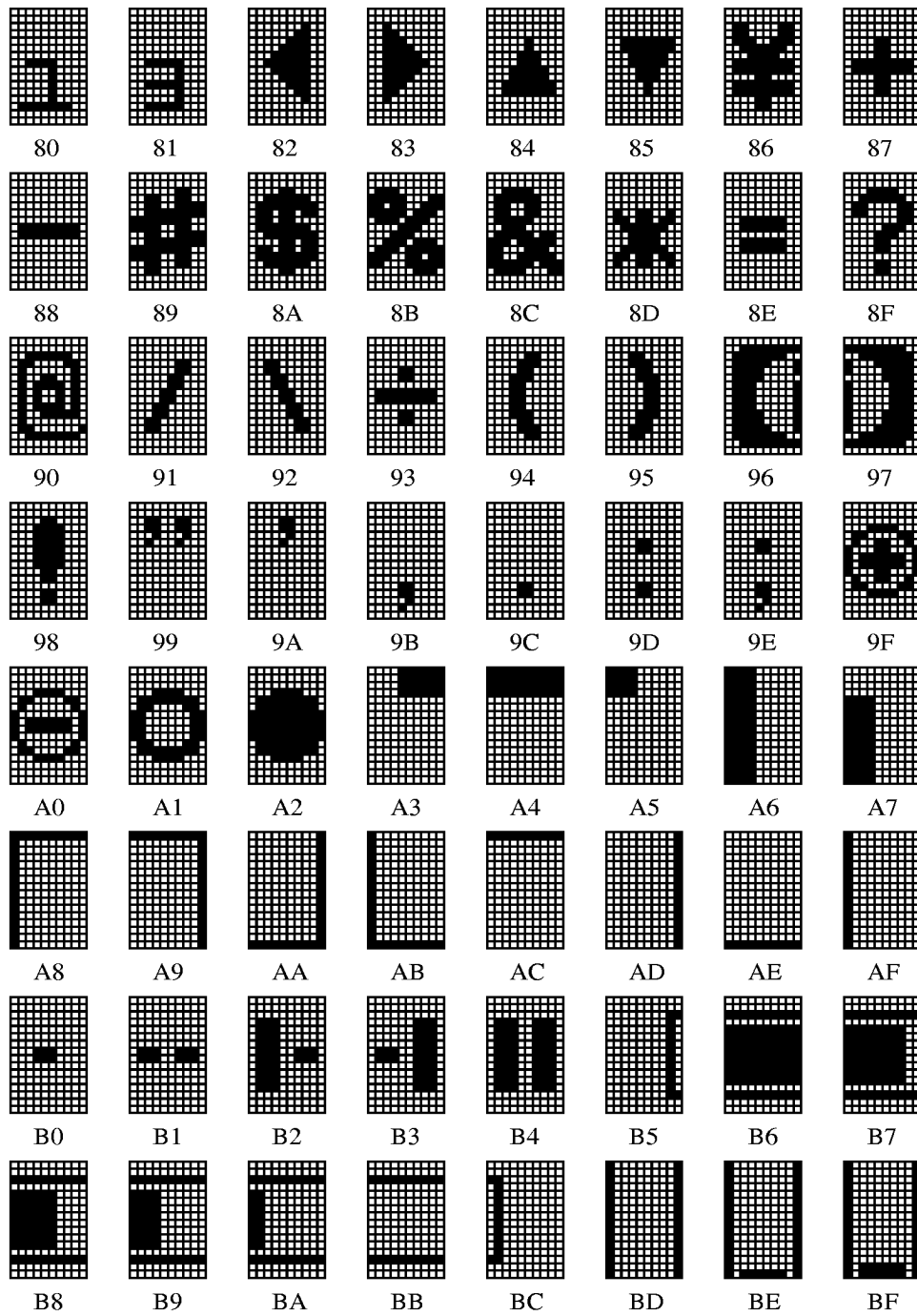

Figure 18. ROM Address (\$80 – \$BF)

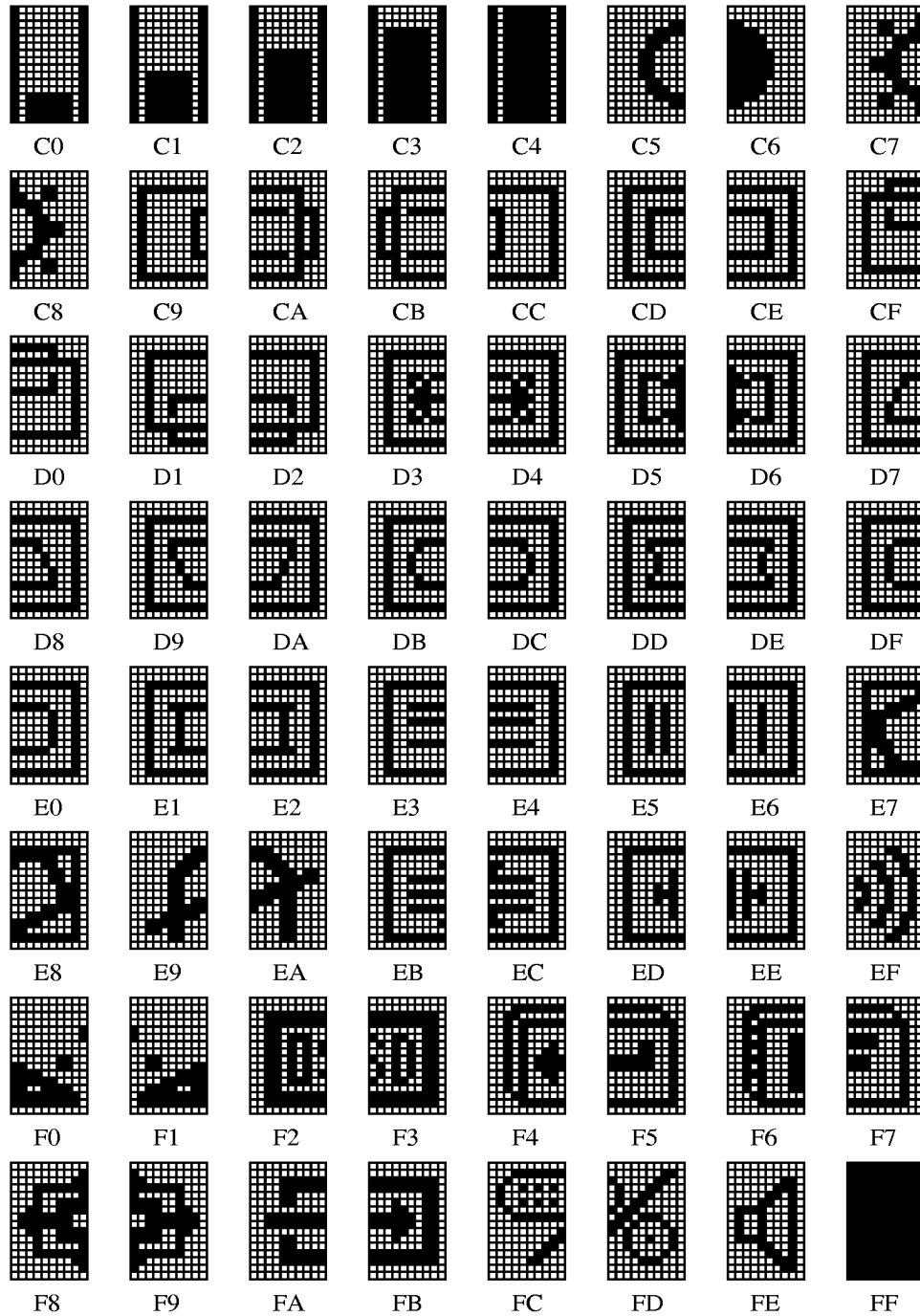

Figure 19. ROM Address (\$C0 – \$FF)

DESIGN CONSIDERATIONS

Distortion

Motorola's MC141549P2 has a built-in PLL for multisystems application. Pin 2 voltage is a dc basing for the internal VCO in the PLL. When the input frequency (HFLB) in Pin 5 becomes higher, the VCO voltage will increase accordingly. The built-in PLL then has a higher locked frequency output. The frequency should be equal to $320 / 640 \times \text{HFLB}$ (depends on resolution). It is the dot-clock in each horizontal line.

Display distortion is caused by noise in Pin 2. Positive noise makes VCO run faster than normal. The corresponding scan line will be shorter accordingly. In contrast, negative noise causes the scan line to be longer. The net result will be distortion on the display, especially on the right hand side with window turn on.

In order to have distortion-free display, the following recommendations should be considered.

- Only analog part grounds (Pin 2 to Pin 4) can be connected to Pin 1 ($V_{SS(A)}$). V_{SS} and other grounds should connect to PCB common ground. Then the $V_{SS(A)}$ and V_{SS} grounds can be connected by a bead core. Please refer to the application diagram (NOTE: $V_{SS(A)}$ and V_{SS} are connected internally.)
- DC supply path for Pin 9 (V_{DD}) should be separated from other switching devices.
- LC filter should be connected between Pin 9 and Pin 4.

- Biasing and filter networks should be connected to Pin 2 and Pin 3. Refer to the recommended networks in the Application Diagram.
- Two small capacitors can be added between Pin1-Pin2 and Pin3-Pin4 to filter VCO noise if necessary. Values should be small enough to avoid picture unlocking caused by temperature variation.

Jittering and unlocking

Most display jittering is caused by $\overline{\text{HFLB}}$ jittering in Pin 5. Care must be taken if the $\overline{\text{HFLB}}$ signal comes from the fly-back transformer. A short path and shielded cable are recommended for a clean signal. A small capacitor can be added between Pin 5 – Pin 24 to smooth the signal. Refer to the value used in the Application Diagram.

Note: The bead core added between $V_{SS(A)}$ and V_{SS} can also enhance the OSD stability in high frequency $\overline{\text{HFLB}}$ operation.

Display Dancing

Most display dancing is caused by interference of the serial bus. It can be avoided by adding resistors in the bus in series.

APPLICATION DIAGRAM

