

KA2S0680B

Fairchild Power Switch(FPS)

Features

- Wide operating frequency range up to 150KHz
- Pulse by pulse over current limiting
- Over load protection
- Over voltage protection (Min. 23V)
- Internal thermal shutdown function
- Under voltage lockout
- Internal high voltage sense FET
- External sync terminal
- Latch up Mode

Description

The Fairchild Power Switch(FPS) product family is specially designed for an off-line SMPS with minimal external components. The Fairchild Power Switch(FPS) consist of high voltage power SenseFETand current mode PWM controller IC. PWM controller features integrated fixed oscillator, under voltage lockout, leading edge blanking, optimized gate turn-on/turn-off driver, thermal shut down protection, over voltage protection, temperature compensated precision current sources for loop compensation and fault protection circuit. compared to discrete MOSFET and controller or RCC switching converter solution, a Fairchild Power Switch(FPS) can reduce total component count, design size, weight and at the same time increase & efficiency, productivity, and system reliability. It has a basic platform well suited for cost effective design in monitor power supply.

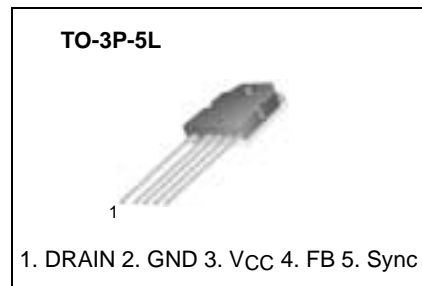

Internal Block Diagram

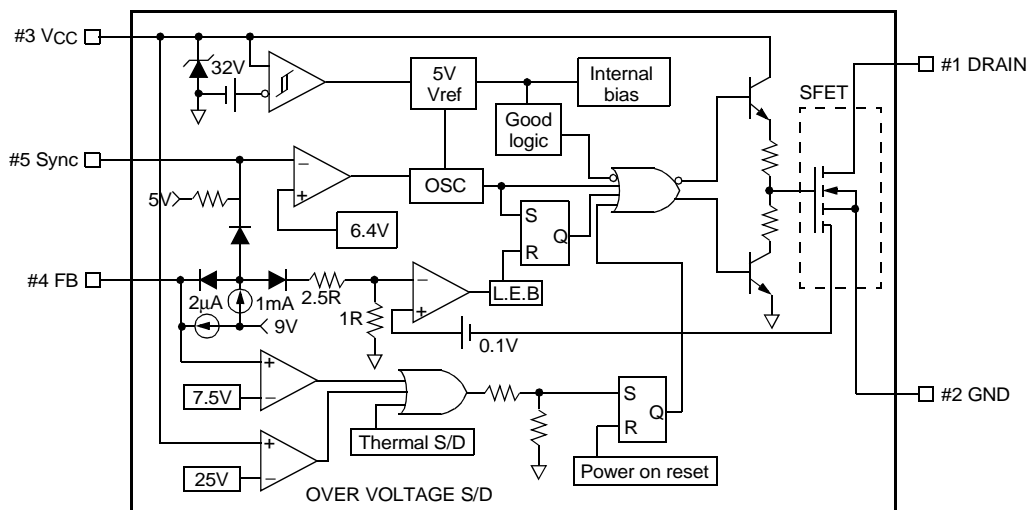

Absolute Maximum Ratings

| Parameter | Symbol | Value | Unit |
|--|---------------------|-------------------------|------|
| Maximum Drain voltage ⁽¹⁾ | V _{D,MAX} | 800 | V |
| Drain Gate voltage (R _{GS} =1MΩ) | V _{DGR} | 800 | V |
| Gate source (GND) voltage | V _{GS} | ±30 | V |
| Drain current pulsed ⁽²⁾ | I _{DM} | 24.0 | ADC |
| Single pulsed avalanche energy ⁽³⁾ | E _{AS} | 455 | mJ |
| Avalanche current ⁽⁴⁾ | I _{AS} | 20 | A |
| Continuous drain current (T _C =25°C) | I _D | 6.0 | ADC |
| Continuous drain current (T _C =100°C) | I _D | 4.0 | ADC |
| Maximum Supply voltage | V _{CC,MAX} | 30 | V |
| Input voltage range | V _{FB} | -0.3 to V _{SD} | V |
| Total power dissipation | P _D | 150 | W |
| | Derating | 1.21 | W/°C |
| Operating ambient temperature | T _A | -25 to +85 | °C |
| Storage temperature | T _{STG} | -55 to +150 | °C |

Notes:

1. T_j=25°C to 150°C
2. Repetitive rating: Pulse width limited by maximum junction temperature
3. L=24mH, V_{DD}=50V, R_G=25Ω, starting T_j=25°C
4. L=13μH, starting T_j=25°C

Electrical Characteristics (SFET part)

(Ta=25°C unless otherwise specified)

| Parameter | Symbol | Condition | Min. | Typ. | Max. | Unit |
|---|---------------------|--|------|------|------|------|
| Drain source breakdown voltage | BV _{DSS} | V _{GS} =0V, I _D =50μA | 800 | - | - | V |
| Zero gate voltage drain current | I _{DSS} | V _{DS} =Max., Rating, V _{GS} =0V | - | - | 50 | μA |
| | | V _{DS} =0.8Max., Rating, V _{GS} =0V, T _C =125°C | - | - | 200 | μA |
| Static drain source on resistance ^(note) | R _{DS(ON)} | V _{GS} =10V, I _D =4.0A | - | 1.6 | 2.0 | Ω |
| Forward transconductance ^(note) | g _{fs} | V _{DS} =15V, I _D =4.0A | 1.5 | 2.5 | - | S |
| Input capacitance | C _{iss} | V _{GS} =0V, V _{DS} =25V, f=1MHz | - | 1600 | - | pF |
| Output capacitance | C _{oss} | | - | 140 | - | |
| Reverse transfer capacitance | C _{rss} | | - | 42 | - | |
| Turn on delay time | t _{d(on)} | V _{DD} =0.5BV _{DSS} , I _D =6.0A (MOSFET switching time are essentially independent of operating temperature) | - | 60 | - | nS |
| Rise time | t _r | | - | 150 | - | |
| Turn off delay time | t _{d(off)} | | - | 300 | - | |
| Fall time | t _f | | - | 130 | - | |
| Total gate charge (gate-source+gate-drain) | Q _g | V _{GS} =10V, I _D =6.0A, V _{DS} =0.5BV _{DSS} (MOSFET switching time are essentially independent of operating temperature) | - | 70 | - | nC |
| Gate source charge | Q _{gs} | | - | 16 | - | |
| Gate drain (Miller) charge | Q _{gd} | | - | 27 | - | |

Note:

Pulse test: Pulse width ≤ 300μS, duty cycle ≤ 2%

$$S = \frac{1}{R}$$

Electrical Characteristics (CONTROL part)

(Ta=25°C unless otherwise specified)

| Parameter | Symbol | Condition | Min. | Typ. | Max. | Unit |
|--|---------------------|-------------------------|------|------|------|-------|
| UVLO SECTION | | | | | | |
| Start threshold voltage | VSTART | - | 14 | 15 | 16 | V |
| Stop threshold voltage | VSTOP | After turn on | 9 | 10 | 11 | V |
| OSCILLATOR SECTION | | | | | | |
| Initial accuracy | FOSC | Ta=25°C | 18 | 20 | 22 | kHz |
| Frequency change with temperature ⁽²⁾ | $\Delta F/\Delta T$ | -25°C ≤ Ta ≤ +85°C | - | ±5 | ±10 | % |
| Maximum duty cycle | Dmax | - | 92 | 95 | 98 | % |
| FEEDBACK SECTION | | | | | | |
| Feedback source current | IFB | Ta=25°C, Vfb=GND | 0.7 | 0.9 | 1.1 | mA |
| Shutdown Feedback voltage | VSD | - | 6.9 | 7.5 | 8.1 | V |
| Shutdown delay current | Idelay | Ta=25°C, 5V ≤ Vfb ≤ VSD | 1.4 | 1.8 | 2.2 | μA |
| SYNC. & SOFT START SECTION | | | | | | |
| Soft start voltage | VSS | VFB=2V | 4.7 | 5.0 | 5.3 | V |
| Soft start current | ISS | Sync & S/S=GND | 0.8 | 1.0 | 1.2 | mA |
| Sync threshold voltage ⁽³⁾ | VSYTH | Vfb=5V | 6.0 | 6.4 | 6.8 | V |
| REFERENCE SECTION | | | | | | |
| Output voltage ⁽¹⁾ | Vref | Ta=25°C | 4.80 | 5.00 | 5.20 | V |
| Temperature Stability ⁽¹⁾⁽²⁾ | Vref/ΔT | -25°C ≤ Ta ≤ +85°C | - | 0.3 | 0.6 | mV/°C |
| CURRENT LIMIT (SELF-PROTECTION) SECTION | | | | | | |
| Peak Current Limit | I _{OVER} | Max. inductor current | 3.52 | 4.00 | 4.48 | A |
| PROTECTION SECTION | | | | | | |
| Thermal shutdown temperature (Tj) ⁽¹⁾ | TSD | - | 140 | 160 | - | °C |
| Over voltage protection voltage | VOVP | - | 23 | 25 | 28 | V |
| TOTAL DEVICE SECTION | | | | | | |
| Start Up current | I _{START} | VCC=14V | 0.1 | 0.3 | 0.55 | mA |
| Operating supply current (control part only) | I _{OP} | Ta=25°C | 6 | 12 | 18 | mA |
| VCC zener voltage | VZ | ICC=20mA | 30 | 32.5 | 35 | V |

Note:

1. These parameters, although guaranteed, are not 100% tested in production
2. These parameters, although guaranteed, are tested in EDS (wafer test) process
3. The amplitude of the sync. pulse is recommended to be between 2V and 3V for stable sync. function.

Typical Performance Characteristics

(These characteristic graphs are normalized at $T_a=25^\circ\text{C}$)

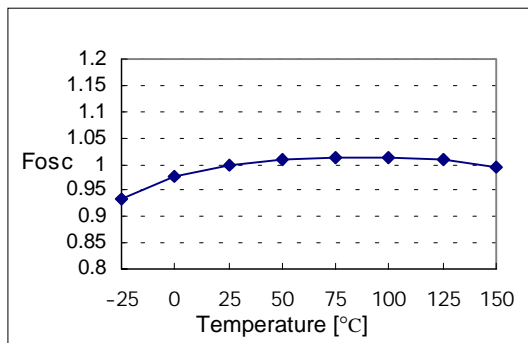

Figure 1. Operating Frequency

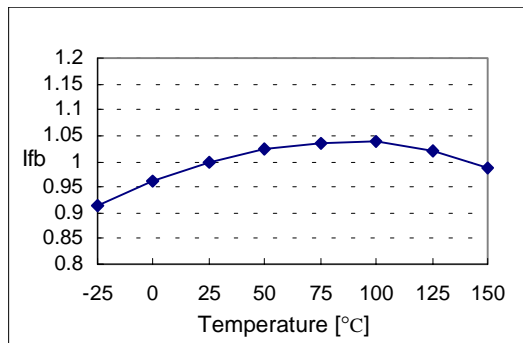

Figure 2. Feedback Source Current

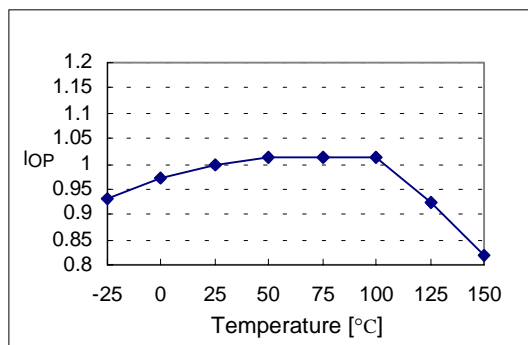

Figure 3. Operating Supply Current

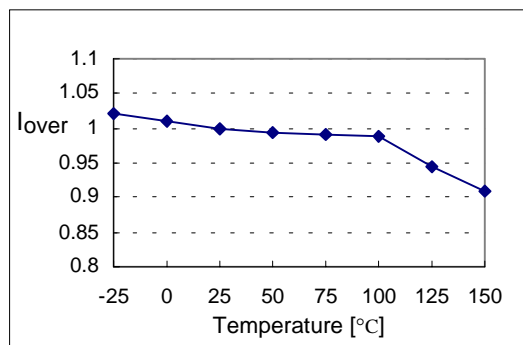

Figure 4. Peak Current Limit

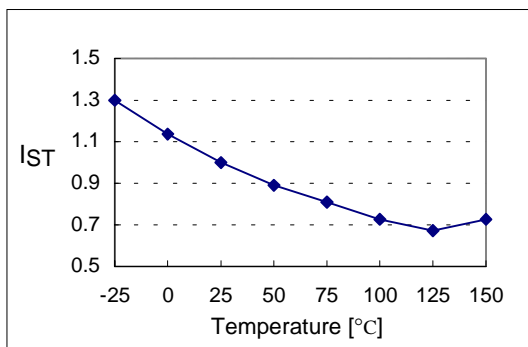

Figure 5. Start up Current

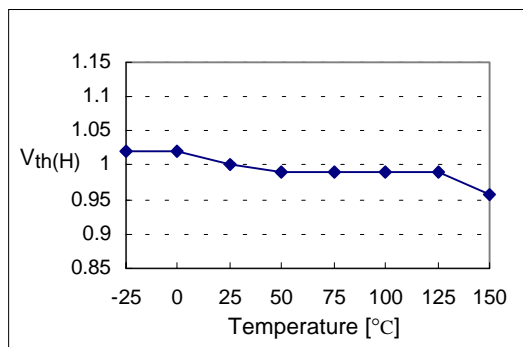

Figure 6. Start Threshold Voltage

Typical Performance Characteristics (Continued)

(These characteristic graphs are normalized at Ta=25°C)

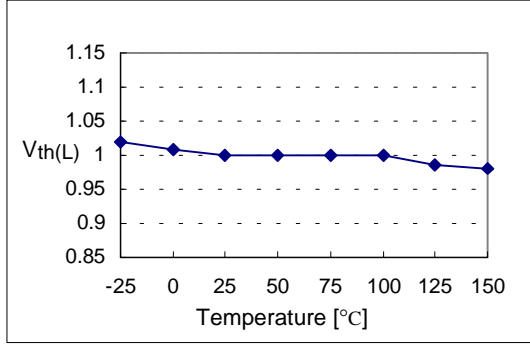

Figure 7. Stop Threshold Voltage

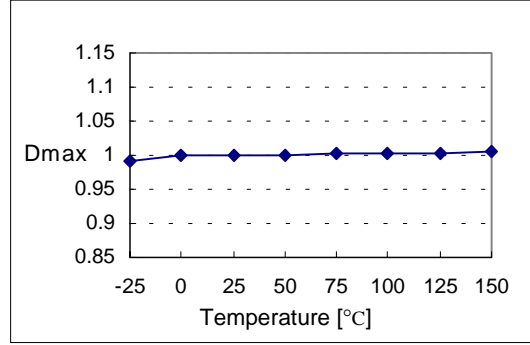

Figure 8. Maximum Duty Cycle

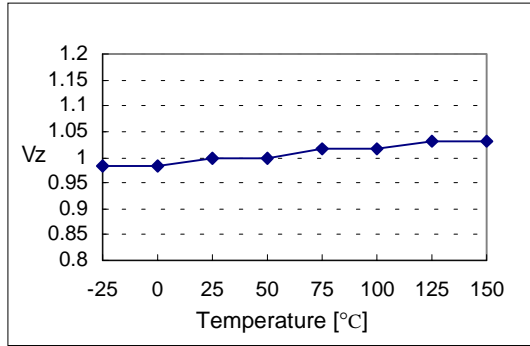

Figure 9. VCC Zener Voltage

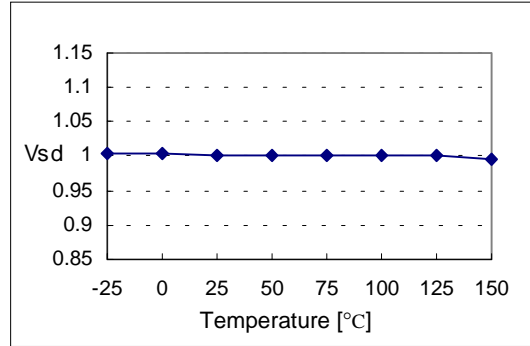

Figure 10. Shutdown Feedback Voltage

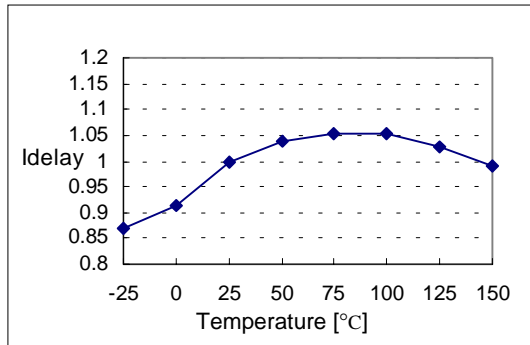

Figure 11. Shutdown Delay Current

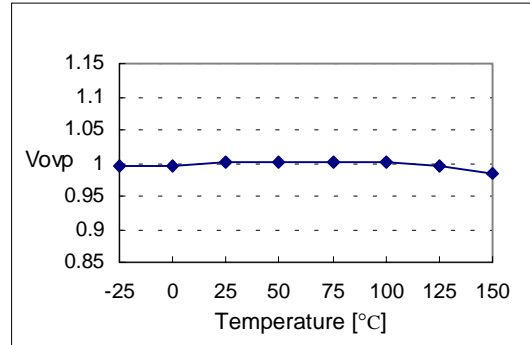

Figure 12. Over Voltage Protection

Typical Performance Characteristics (Continued)

(These characteristic graphs are normalized at $T_a=25^\circ\text{C}$)

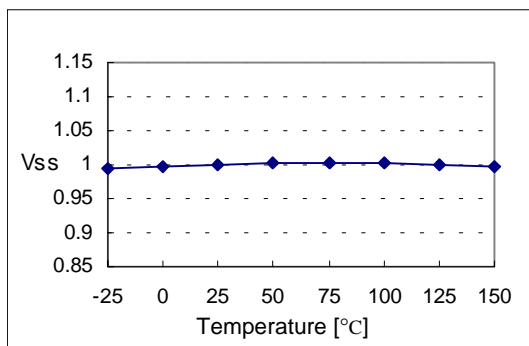

Figure 13. Soft Start Voltage

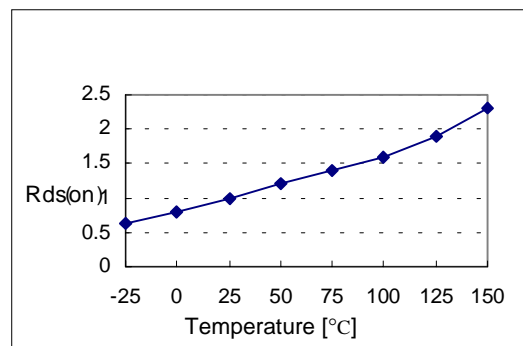
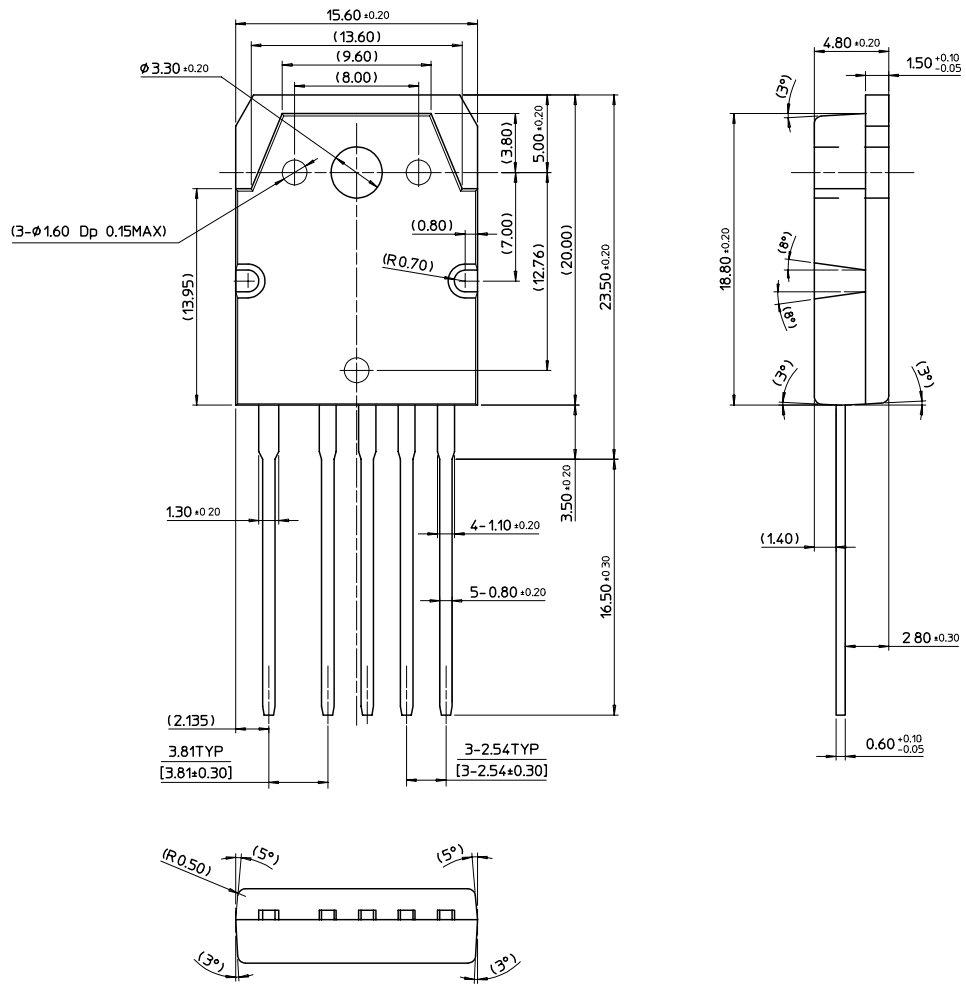

Figure 14. Static Drain-Source on Resistance

Package Dimensions

TO-3P-5L



Ordering Information

| Product Number | Package | Rating | Operating Temperature |
|----------------|-------------------|---------|-----------------------|
| KA2S0680B-TU | TO-3P-5L | 800V,6A | -25°C to +85°C |
| KA2S0680B-YDTU | TO-3P-5L(Forming) | | |

TU : Non Forming Type

YDTU : Forming Type

DISCLAIMER

FAIRCHILD SEMICONDUCTOR RESERVES THE RIGHT TO MAKE CHANGES WITHOUT FURTHER NOTICE TO ANY PRODUCTS HEREIN TO IMPROVE RELIABILITY, FUNCTION OR DESIGN. FAIRCHILD DOES NOT ASSUME ANY LIABILITY ARISING OUT OF THE APPLICATION OR USE OF ANY PRODUCT OR CIRCUIT DESCRIBED HEREIN; NEITHER DOES IT CONVEY ANY LICENSE UNDER ITS PATENT RIGHTS, NOR THE RIGHTS OF OTHERS.

LIFE SUPPORT POLICY

FAIRCHILD'S PRODUCTS ARE NOT AUTHORIZED FOR USE AS CRITICAL COMPONENTS IN LIFE SUPPORT DEVICES OR SYSTEMS WITHOUT THE EXPRESS WRITTEN APPROVAL OF THE PRESIDENT OF FAIRCHILD SEMICONDUCTOR CORPORATION. As used herein:

1. Life support devices or systems are devices or systems which, (a) are intended for surgical implant into the body, or (b) support or sustain life, and (c) whose failure to perform when properly used in accordance with instructions for use provided in the labeling, can be reasonably expected to result in a significant injury of the user.
2. A critical component in any component of a life support device or system whose failure to perform can be reasonably expected to cause the failure of the life support device or system, or to affect its safety or effectiveness.