

# 3280, 3281, AND 3283

## CHOPPER-STABILIZED, PRECISION HALL-EFFECT LATCHES

### Suffix '-LT' & '-UA' Pinning

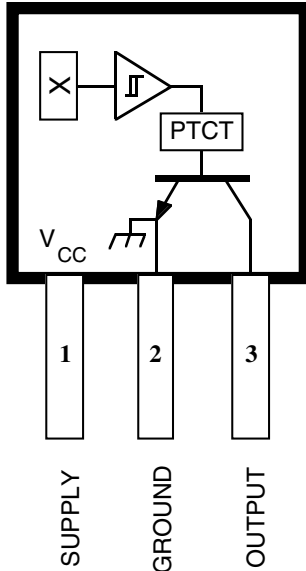

Dwg. PH-003-2

Pinning is shown viewed from branded side.

### ABSOLUTE MAXIMUM RATINGS at $T_A = +25^\circ\text{C}$

Supply Voltage, $V_{CC}$ .....	26.5 V
Reverse Battery Voltage, $V_{RCC}$ .....	-30 V
Magnetic Flux Density, $B$ .....	Unlimited
Output Off Voltage, $V_{OUT}$ .....	26 V
Continuous Output Current, $I_{OUT}$ .....	Internally Limited
Reverse Output Current, $I_{OUT}$ .....	-50 mA
Package Power Dissipation, $P_D$ .....	See Graph
Junction Temperature, $T_J$ .....	+170°C
Operating Temperature Range, $T_A$	
Suffix 'E-' .....	-40°C to +85°C
Suffix 'L-' .....	-40°C to +150°C
Storage Temperature Range, $T_S$ .....	-65°C to +170°C

The A3280--, A3281--, and A3283-- Hall-effect latches are extremely temperature-stable and stress-resistant sensors especially suited for operation over extended temperature ranges to +150°C. Superior high-temperature performance is made possible through dynamic offset cancellation, which reduces the residual offset voltage normally caused by device overmolding, temperature dependencies, and thermal stress. The three devices are identical except for magnetic switch points.

Each device includes on a single silicon chip a voltage regulator, Hall-voltage generator, small-signal amplifier, chopper stabilization, Schmitt trigger, and a short-circuit protected open-collector output to sink up to 25 mA. A south pole of sufficient strength will turn the output on. A north pole is necessary to turn the output off. An on-board regulator permits operation with supply voltages of 4.2 to 24 volts.

The first character of the part number suffix determines the device operating temperature range; suffix 'E-' is for -40°C to +85°C and 'L-' is -40°C to +150°C. Three package styles provide a magnetically optimized package for most applications. Suffix '-LH' is a miniature low-profile surface-mount package, '-LT' is a miniature SOT-89/TO-243AA transistor package for surface-mount applications; while suffix '-UA' is a three-lead ultra-mini-SIP for through-hole mounting.

### FEATURES

- Symmetrical Switch Points
- Resistant to Physical Stress
- Superior Temperature Stability
- Output Short-Circuit Protection
- Operation From Unregulated Supply
- Reverse Battery Protection
- Solid-State Reliability
- Small Size

Always order by complete part number: the prefix 'A' + the basic four-digit part number + a suffix to indicate operating temperature range + a suffix to indicate package style, e.g., **A3281ELH** .

# 3280, 3281, AND 3283 CHOPPER-STABILIZED, PRECISION HALL-EFFECT LATCHES

## FUNCTIONAL BLOCK DIAGRAM

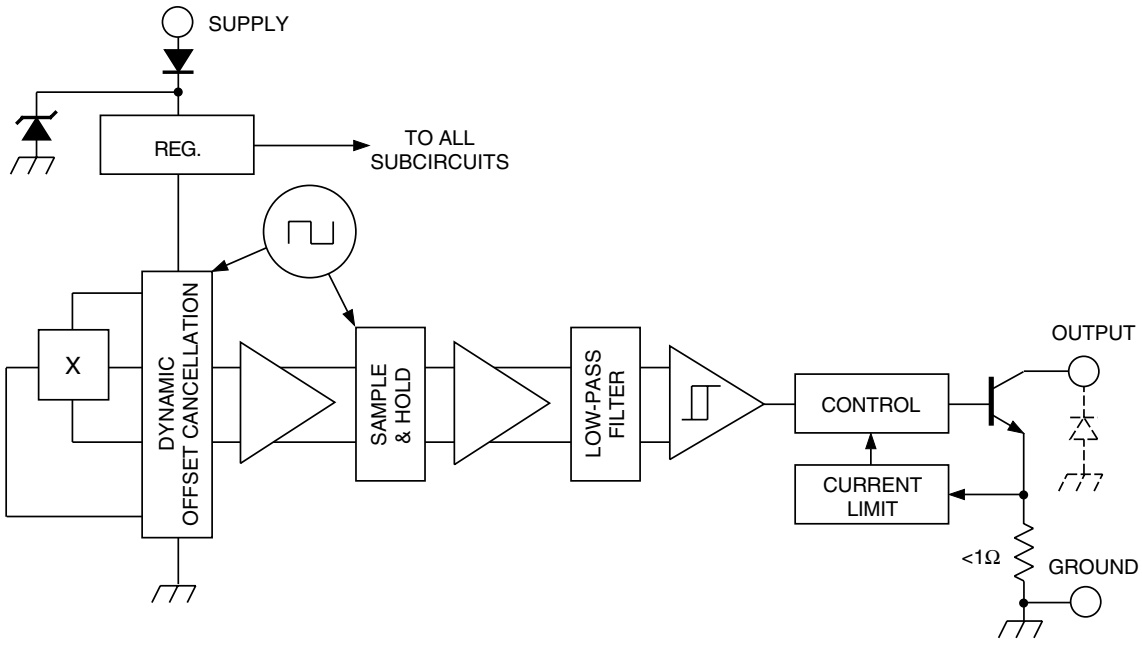

Dwg. FH-020-1

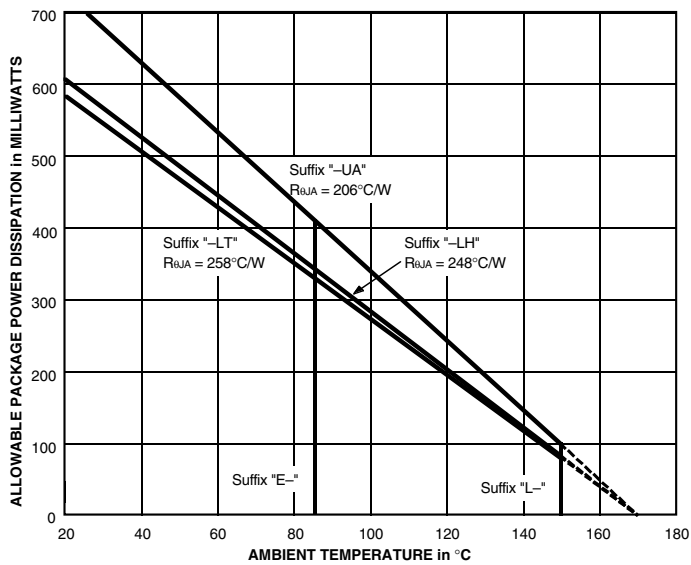

Dwg. GH-046-2C

## Suffix '-LH' Pinning

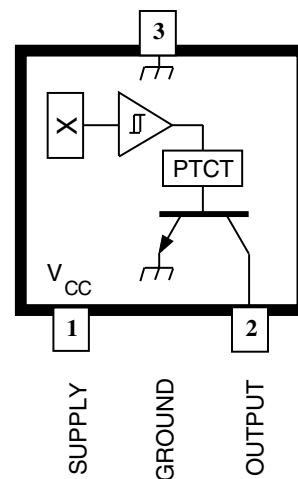

Dwg. PH-003-4

**3280, 3281, AND 3283  
CHOPPER-STABILIZED,  
PRECISION  
HALL-EFFECT LATCHES**

**ELECTRICAL CHARACTERISTICS over operating temperature range.**

Characteristic	Symbol	Test Conditions	Limits			
			Min.	Typ.	Max.	Units
Supply Voltage Range	$V_{CC}$	Operating, $T_J < 170^\circ\text{C}^1$	4.2	–	24	V
Output Leakage Current	$I_{OFF}$	$V_{OUT} = 24\text{ V}$ , $B < B_{RP}$	–	–	10	$\mu\text{A}$
Output Saturation Voltage	$V_{OUT(SAT)}$	$I_{OUT} = 20\text{ mA}$ , $B > B_{OP}$	–	185	500	mV
Output Current Limit	$I_{OM}$	$B > B_{OP}$	30	–	60	mA
Power-On Time	$t_{po}$	$V_{CC} > 4.2\text{ V}$	–	–	50	$\mu\text{s}$
Chopping Frequency	$f_C$		–	340	–	kHz
Output Rise Time	$t_r$	$R_L = 820\ \Omega$ , $C_L = 20\text{ pF}$	–	0.2	2.0	$\mu\text{s}$
Output Fall Time	$t_f$	$R_L = 820\ \Omega$ , $C_L = 20\text{ pF}$	–	0.1	2.0	$\mu\text{s}$
Supply Current	$I_{CC}$	$B < B_{RP}$ , $V_{CC} = 12\text{ V}$	–	3.0	8.0	mA
		$B > B_{OP}$ , $V_{CC} = 12\text{ V}$	–	4.0	8.0	mA
Reverse Battery Current	$I_{CC}$	$V_{RCC} = -30\text{ V}$	–	–	-5.0	mA
Zener Voltage	$V_Z + V_D$	$I_{CC} = 15\text{ mA}$ , $T_A = 25^\circ\text{C}$	28	32	37	V
Zener Impedance	$Z_Z + Z_D$	$I_{CC} = 15\text{ mA}$ , $T_A = 25^\circ\text{C}$	–	50	–	$\Omega$

- NOTES: 1. Maximum voltage must be adjusted for power dissipation and junction temperature.  
 2.  $B_{OP}$  = operate point (output turns on);  $B_{RP}$  = release point (output turns off).  
 3. Typical Data is at  $T_A = +25^\circ\text{C}$  and  $V_{CC} = 12\text{ V}$  and is for design information only.

**MAGNETIC CHARACTERISTICS over operating supply voltage range.**

Characteristic	Test Conditions	Part Numbers <sup>1</sup>									Units
		A3280			A3281			A3283			
		Min.	Typ.	Max.	Min.	Typ.	Max.	Min.	Typ.	Max.	
Operate Point, $B_{OP}$	at $T_A = +25^\circ\text{C}$ and $T_A = \text{max.}$	5.0	22	40	15	50	90	100	150	180	G
	at $T_A = -40^\circ\text{C}$	5.0	–	40	15	–	90	100	–	200	G
Release Point, $B_{RP}$	at $T_A = +25^\circ\text{C}$ and $T_A = \text{max.}$	-40	-23	-5.0	-90	-50	-15	-180	-150	-100	G
	at $T_A = -40^\circ\text{C}$	-40	–	-5.0	-90	–	-15	-200	–	-100	G
Hysteresis, $B_{hys}$ ( $B_{OP} - B_{RP}$ )	at $T_A = +25^\circ\text{C}$ and $T_A = \text{max.}$	10	45	80	30	100	180	–	300	360	G
	at $T_A = -40^\circ\text{C}$	–	–	80	–	–	180	–	–	400	G

- NOTES: 1. Complete part number includes a suffix to identify operating temperature range (E or L) and package type (LH, LT, or UA).  
 2. As used here, negative flux densities are defined as less than zero (algebraic convention) and -50 G is less than +10 G.  
 3. Typical Data is at  $T_A = +25^\circ\text{C}$  and  $V_{CC} = 12\text{ V}$  and is for design information only.

# 3280, 3281, AND 3283 CHOPPER-STABILIZED, PRECISION HALL-EFFECT LATCHES

## TYPICAL OPERATING CHARACTERISTICS as a function of temperature

A3280\* SWITCH POINTS

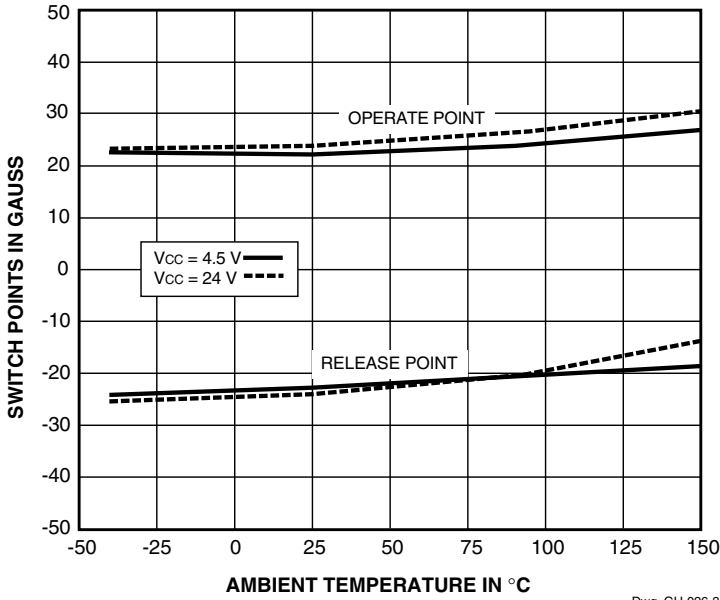

A3281\* SWITCH POINTS

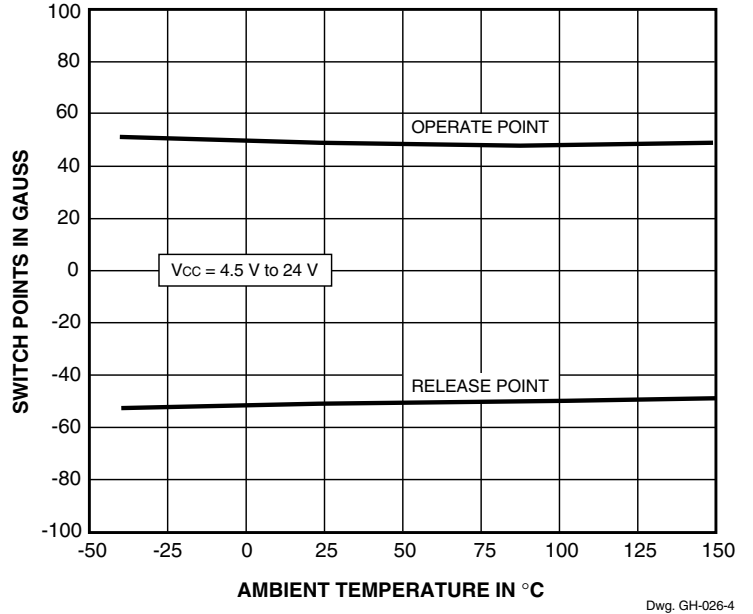

A3283\* SWITCH POINTS

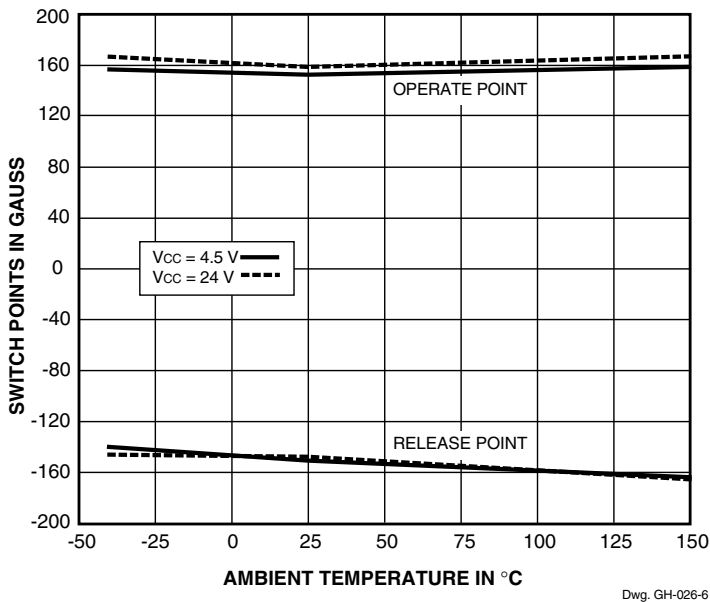

\* Complete part number includes a suffix denoting operating temperature range (E or L) and package type (LH, LT, or UA).

# 3280, 3281, AND 3283 CHOPPER-STABILIZED, PRECISION HALL-EFFECT LATCHES

## TYPICAL OPERATING CHARACTERISTICS as a function of temperature (cont'd)

**OUTPUT SATURATION VOLTAGE**

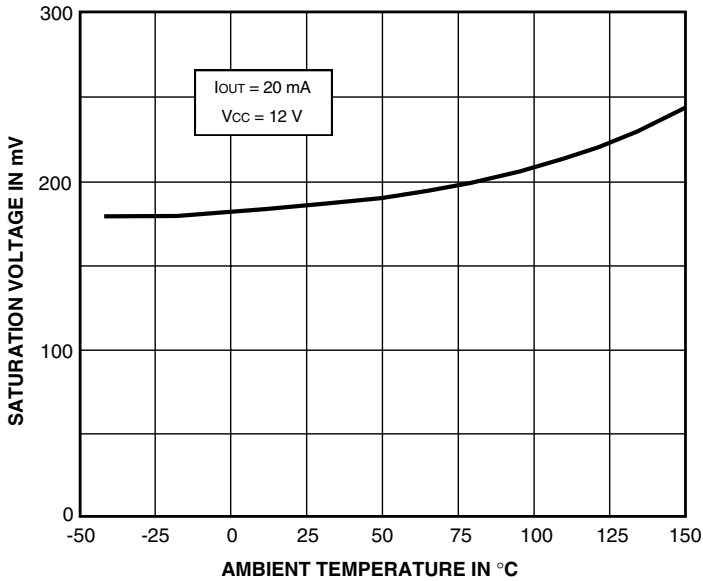

Dwg. GH-029-4

**SUPPLY CURRENT**

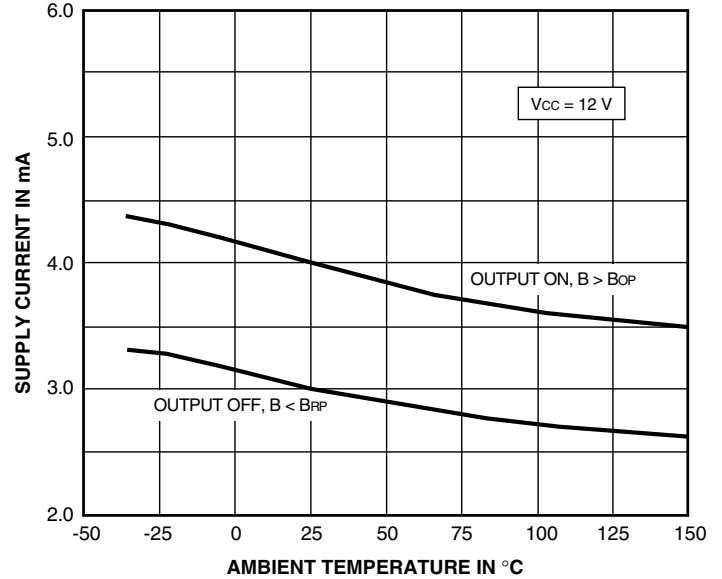

Dwg. GH-028-5

## TYPICAL OPERATING CHARACTERISTICS as a function of supply voltage

**A3280\* SWITCH POINTS**

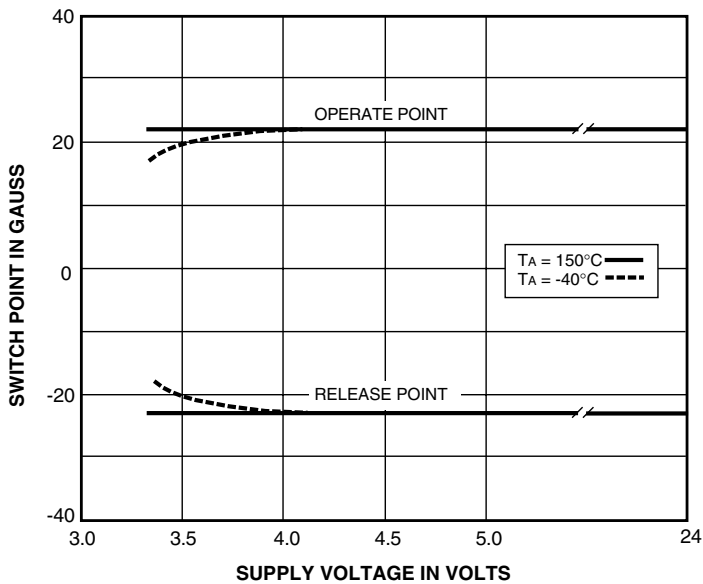

Dwg. GH-021-3

**A3281\* SWITCH POINTS**

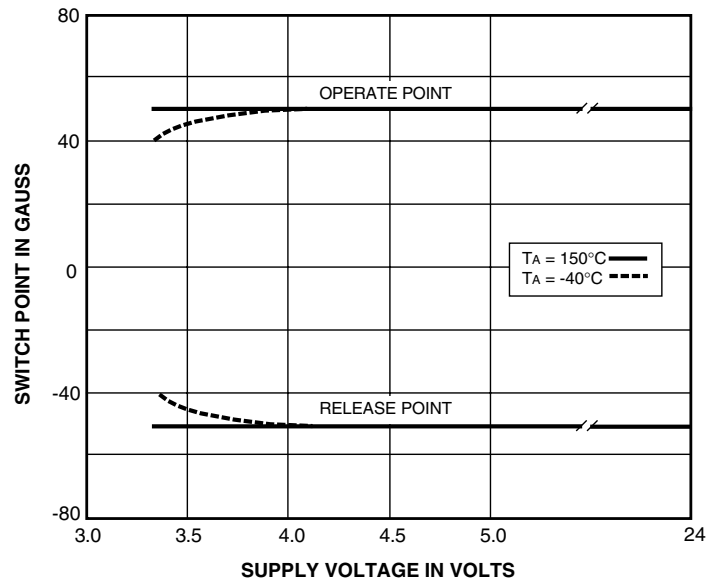

Dwg. GH-021-1

\* Complete part number includes a suffix denoting operating temperature range (E or L) and package type (LH, LT, or UA).

# 3280, 3281, AND 3283 CHOPPER-STABILIZED, PRECISION HALL-EFFECT LATCHES

## SENSOR LOCATIONS ( $\pm 0.005$ " [0.13 mm] die placement)

### Package Designator 'LH'

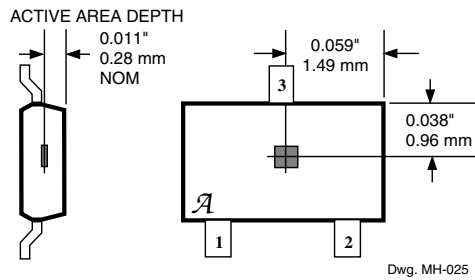

### Package Designator 'LT'

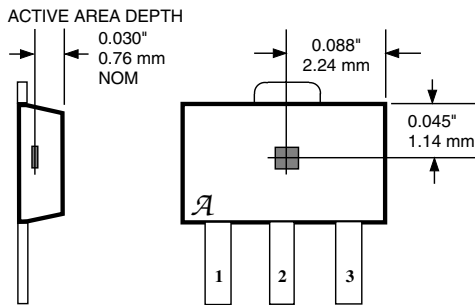

### Package Designators 'UA' and 'UA-TL'

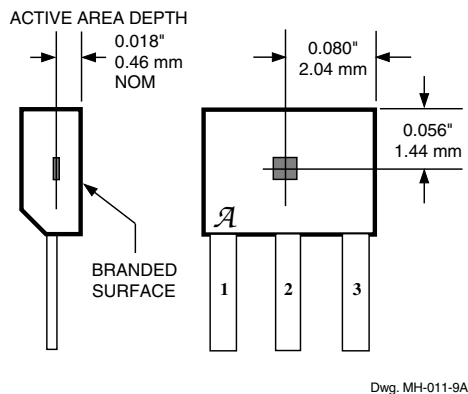

## TYPICAL OPERATING CHARACTERISTICS as a function of supply voltage (cont'd)

### OUTPUT SATURATION VOLTAGE

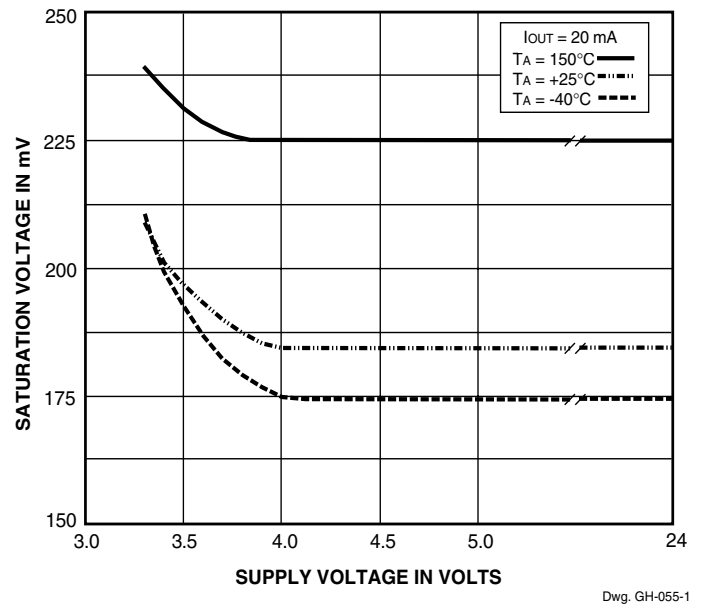

### SUPPLY CURRENT

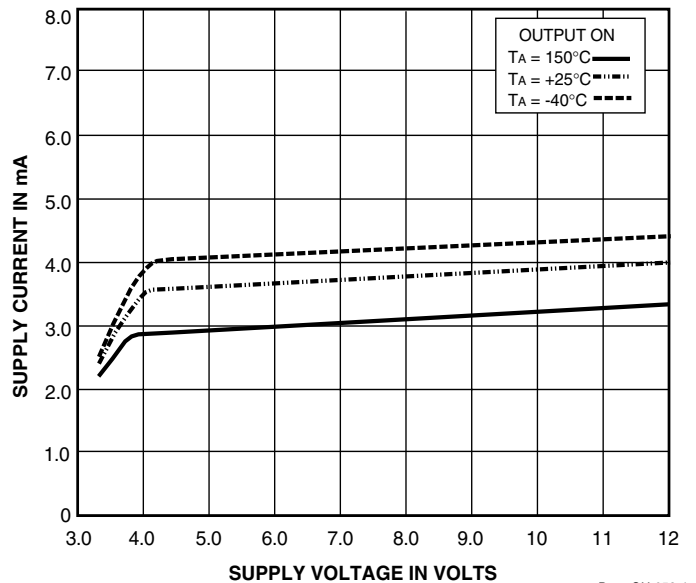

Although sensor location is accurate to three sigma for a particular design, product improvements may result in small changes to sensor location.

**3280, 3281, AND 3283  
CHOPPER-STABILIZED,  
PRECISION  
HALL-EFFECT LATCHES**

**CRITERIA FOR DEVICE QUALIFICATION**

All Allegro sensors are subjected to stringent qualification requirements prior to being released to production. To become qualified, except for the destructive ESD tests, no failures are permitted.

Qualification Test	Test Method and Test Conditions	Test Length	Samples	Comments
Biased Humidity (HAST)	$T_A = 130^{\circ}\text{C}$ , RH = 85%	50 hrs	77	$V_{CC} = V_{OUT} = 5\text{ V}$
High-Temperature Operating Life (HTOL)	JESD22-A108, $T_A = 150^{\circ}\text{C}$ , $T_J \leq 170^{\circ}\text{C}$	408 hrs	77	$V_{CC} = 24\text{ V}$ , $V_{OUT} = 20\text{ V}$
Accelerated HTOL	$T_A = 175^{\circ}\text{C}$ , $T_J \leq 190^{\circ}\text{C}$	504 hrs	77	$V_{CC} = 24\text{ V}$ , $V_{OUT} = 20\text{ V}$
Autoclave, Unbiased	JESD22-A102, Condition C, $T_A = 121^{\circ}\text{C}$ , 15 psig	96 hrs	77	
High-Temperature (Bake) Storage Life	MIL-STD-883, Method 1008, $T_A = 170^{\circ}\text{C}$	1000 hrs	77	
Temperature Cycle	MIL-STD-883, Method 1010, $-65^{\circ}\text{C}$ to $+150^{\circ}\text{C}$	500 cycles	77	
Latch-Up	—	Pre/Post Reading	6	
Electro-Thermally Induced Gate Leakage	—	Pre/Post Reading	6	
ESD, Human Body Model	CDF-AEC-Q100-002	Pre/Post Reading	3 per test	Test to failure, All leads > 1500 V
ESD, Machine Model	JESD22-A115	Pre/Post Reading	3 per test	Test to failure, All leads > 200 V
Electrical Distributions	Per Specification	—	30	

# 3280, 3281, AND 3283 CHOPPER-STABILIZED, PRECISION HALL-EFFECT LATCHES

## FUNCTIONAL DESCRIPTION

**Chopper-Stabilized Technique.** The Hall element can be considered as a resistor array similar to a Wheatstone bridge. A large portion of the offset is a result of the mismatching of these resistors. These devices use a proprietary dynamic offset cancellation technique, with an internal high-frequency clock to reduce the residual offset voltage of the Hall element that is normally caused by device overmolding, temperature dependencies, and thermal stress. The chopper-stabilizing technique cancels the mismatching of the resistor circuit by changing the direction of the current flowing through the Hall plate using CMOS switches and Hall voltage measurement taps, while maintaining the Hall-voltage signal that is induced by the external magnetic flux. The signal is then captured by a sample-and-hold circuit and further processed using low-offset bipolar circuitry. This technique produces devices that have an extremely stable quiescent Hall output voltage, are immune to thermal stress, and have precise recoverability after temperature cycling. This technique will also slightly degrade the device output repeatability. A relatively high sampling frequency is used in order that faster signals can be processed.

More detailed descriptions of the circuit operation can be found in: Technical Paper STP 97-10, *Monolithic Magnetic Hall Sensor Using Dynamic Quadrature Offset Cancellation* and Technical Paper STP 99-1, *Chopper-Stabilized Amplifiers With A Track-and-Hold Signal Demodulator*.

**Operation.** The output of these devices switches low (turns on) when a magnetic field perpendicular to the Hall sensor exceeds the operate point threshold ( $B_{OP}$ ). After turn-on, the output is capable of sinking 25 mA and the output voltage is  $V_{OUT(SAT)}$ . Note that the device latches; that is, a south pole of sufficient strength towards the branded surface of the device will turn the device on; removal of the south pole will leave the device on. When the magnetic field is reduced below the release point ( $B_{RP}$ ), the device output goes high (turns off). The difference in the magnetic operate and release points is the hysteresis ( $B_{hys}$ ) of the device. This built-in hysteresis allows clean switching of the output even in the presence of external mechanical vibration and electrical noise.

**Applications.** It is strongly recommended that an external bypass capacitor be connected (in close proximity to the Hall sensor) between the supply and ground of the device to reduce both external noise and noise generated by the chopper-stabilization technique.

The simplest form of magnet that will operate these devices is a ring magnet. Other methods of operation, such as linear magnets, are possible. Extensive applications information on magnets and Hall-effect sensors is also available in the *Allegro Electronic Data Book AMS-702* or *Application Note 27701*, or [www.allegromicro.com](http://www.allegromicro.com)

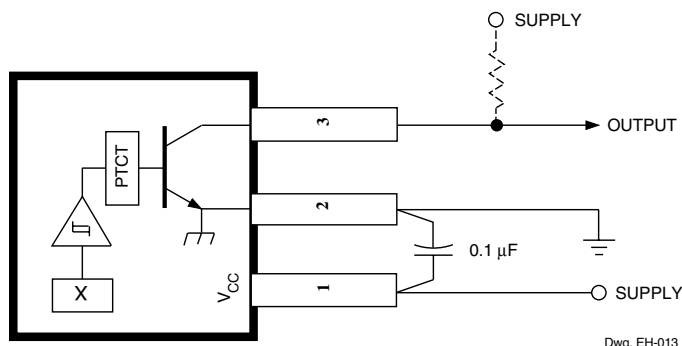
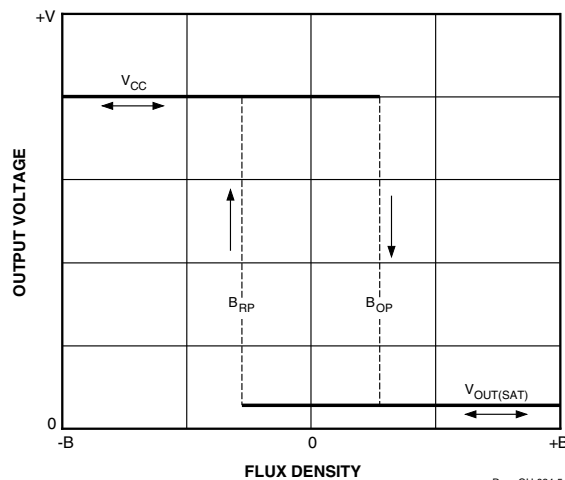
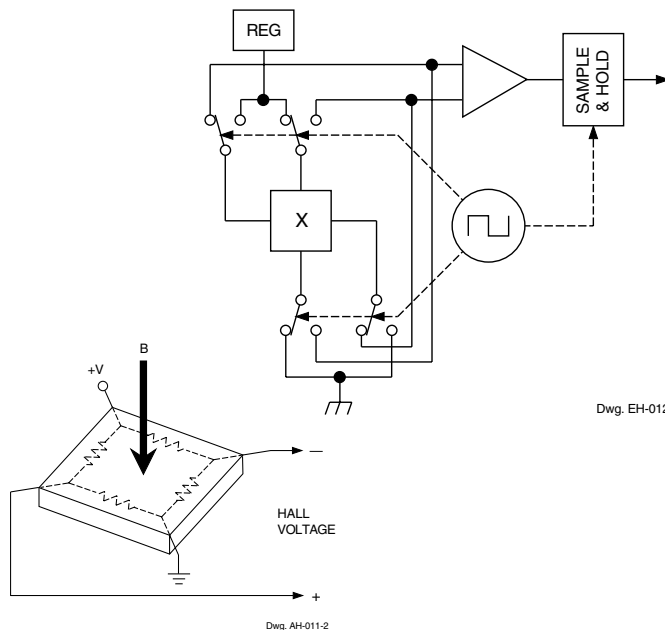



# 3280, 3281, AND 3283 CHOPPER-STABILIZED, PRECISION HALL-EFFECT LATCHES

## PACKAGE DESIGNATOR 'LH'

(fits SC-74A solder-pad layout)

**Dimensions in Inches**  
(for reference only)

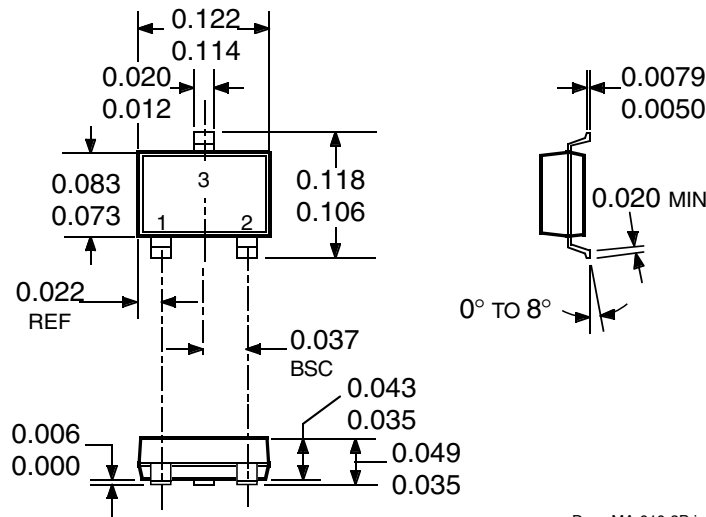

Dwg. MA-010-3B in

**Dimensions in Millimeters**  
(controlling dimensions)

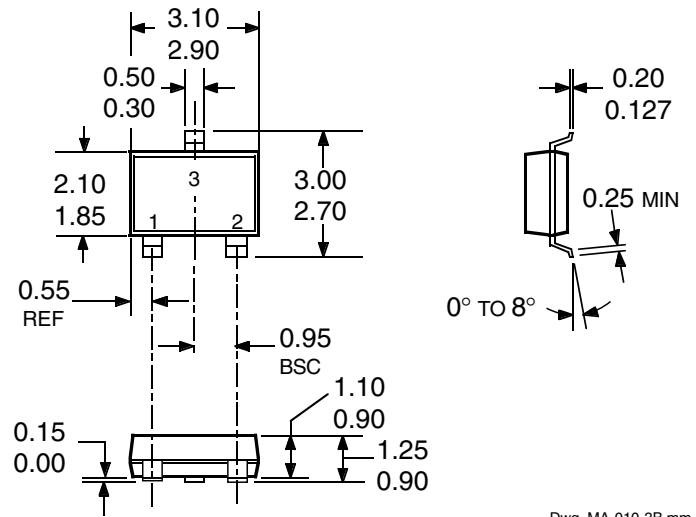

Dwg. MA-010-3B mm

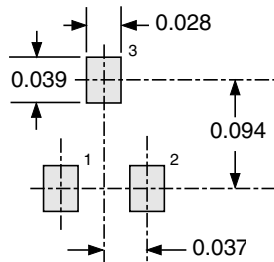

Dwg. MA-011-3 in

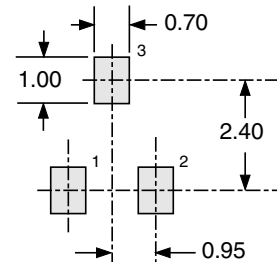

Dwg. MA-011-3 mm

- NOTES:
1. Tolerances on package height and width represent allowable mold offsets. Dimensions given are measured at the widest point (parting line).
  2. Exact body and lead configuration at vendor's option within limits shown.
  3. Height does not include mold gate flash.
  4. Where no tolerance is specified, dimension is nominal.
  5. Add "LT" to part number for tape and reel.

# 3280, 3281, AND 3283 CHOPPER-STABILIZED, PRECISION HALL-EFFECT LATCHES

## PACKAGE DESIGNATOR 'LT' (SOT-89/TO-243AA)

Dimensions in Inches  
(for reference only)

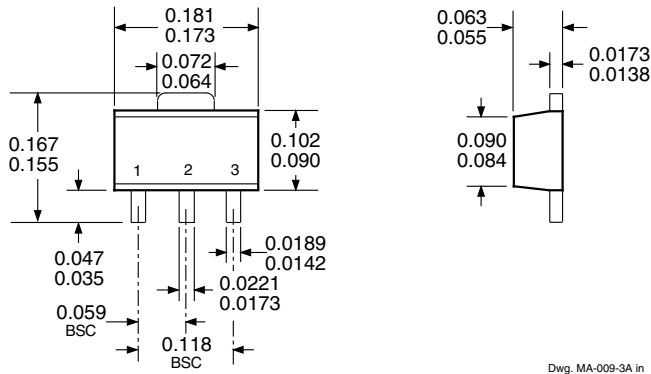

Dimensions in Millimeters  
(controlling dimensions)

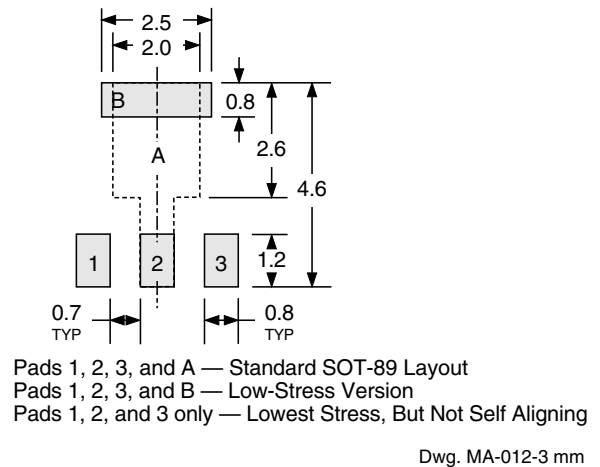
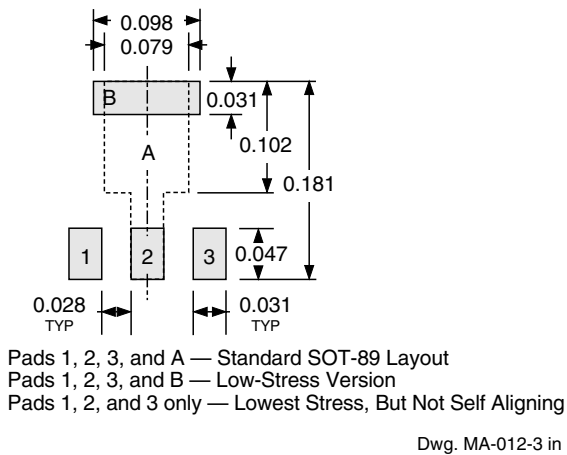
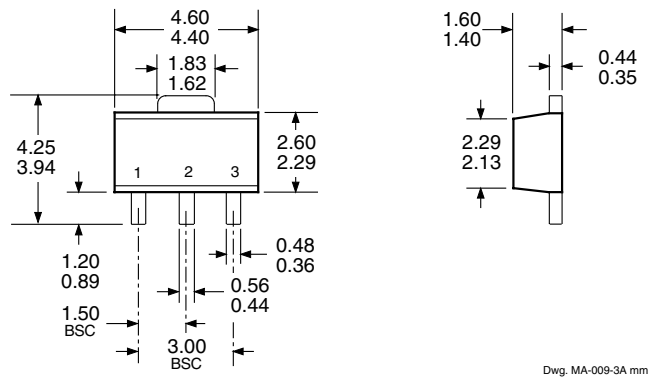

- NOTES: 1. Exact body and lead configuration at vendor's option within limits shown.  
2. Supplied in bulk pack (500 pieces per bag) or add "TR" to part number for tape and reel.

# 3280, 3281, AND 3283 CHOPPER-STABILIZED, PRECISION HALL-EFFECT LATCHES

## PACKAGE DESIGNATOR 'UA'

**Dimensions in Inches**  
(controlling dimensions)

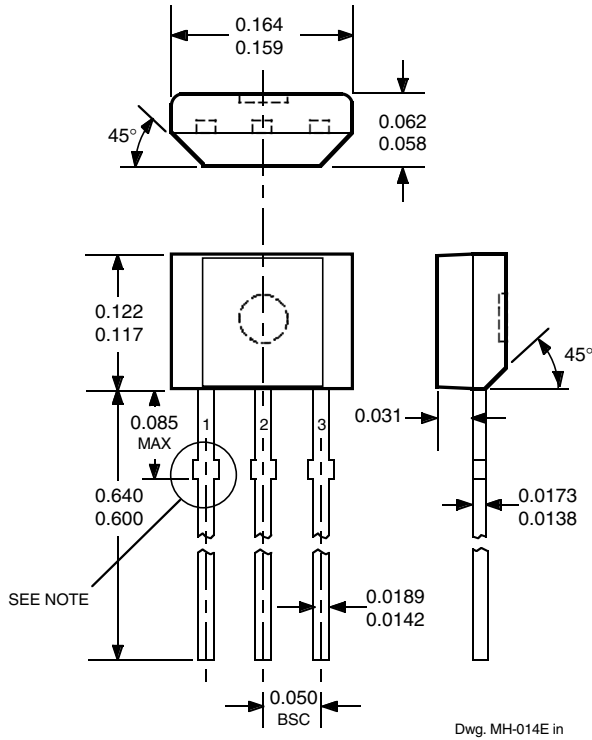

**Dimensions in Millimeters**  
(for reference only)

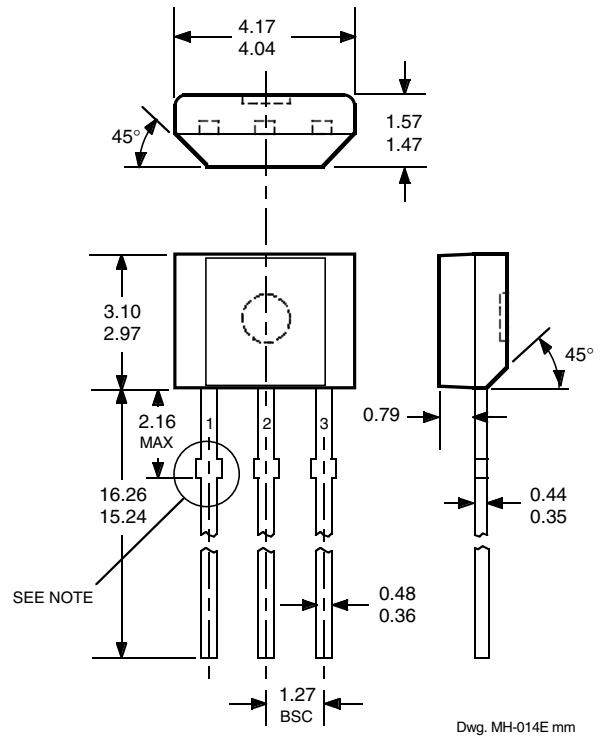

## Surface-Mount Lead Form (order A328xxUA-TL)

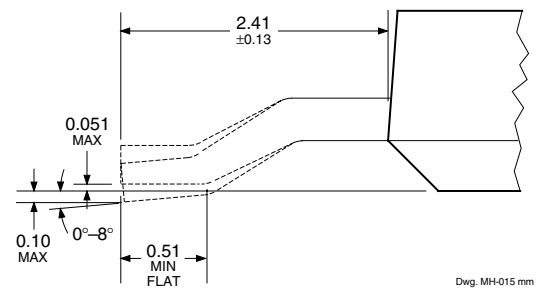
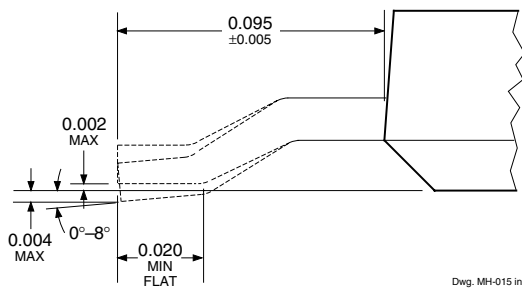

- NOTES:
1. Tolerances on package height and width represent allowable mold offsets. Dimensions given are measured at the widest point (parting line).
  2. Exact body and lead configuration at vendor's option within limits shown.
  3. Height does not include mold gate flash.
  4. Recommended minimum PWB hole diameter to clear transition area is 0.035" (0.89 mm).
  5. Where no tolerance is specified, dimension is nominal.
  6. Supplied in bulk pack (500 pieces per bag).

**3280, 3281, AND 3283  
CHOPPER-STABILIZED,  
PRECISION  
HALL-EFFECT LATCHES**

*The products described herein are manufactured under one or more of the following U.S. patents: 5,045,920; 5,264,783; 5,442,283; 5,389,889; 5,581,179; 5,517,112; 5,619,137; 5,621,319; 5,650,719; 5,686,894; 5,694,038; 5,729,130; 5,917,320; and other patents pending.*

*Allegro MicroSystems, Inc. reserves the right to make, from time to time, such departures from the detail specifications as may be required to permit improvements in the performance, reliability, or manufacturability of its products. Before placing an order, the user is cautioned to verify that the information being relied upon is current.*

*Allegro products are not authorized for use as critical components in life-support appliances, devices, or systems without express written approval.*

*The information included herein is believed to be accurate and reliable. However, Allegro MicroSystems, Inc. assumes no responsibility for its use; nor for any infringements of patents or other rights of third parties that may result from its use.*