



STTA3006CW/CP

TURBOSWITCH™ ULTRA-FAST HIGH VOLTAGE DIODES

MAIN PRODUCT CHARACTERISTICS

| | |
|----------------|---------|
| $I_{F(AV)}$ | 2 x 15A |
| V_{RRM} | 600V |
| t_{rr} (typ) | 35ns |
| V_F (max) | 1.6V |

FEATURES AND BENEFITS

- SPECIFIC TO "FREEWHEEL MODE" OPERATIONS: FREEWHEEL OR BOOSTER DIODE.
- ULTRA-FAST AND SOFT RECOVERY.
- VERY LOW OVERALL POWER LOSSES IN BOTH THE DIODE AND THE COMPANION TRANSISTOR.
- HIGH FREQUENCY OPERATIONS.

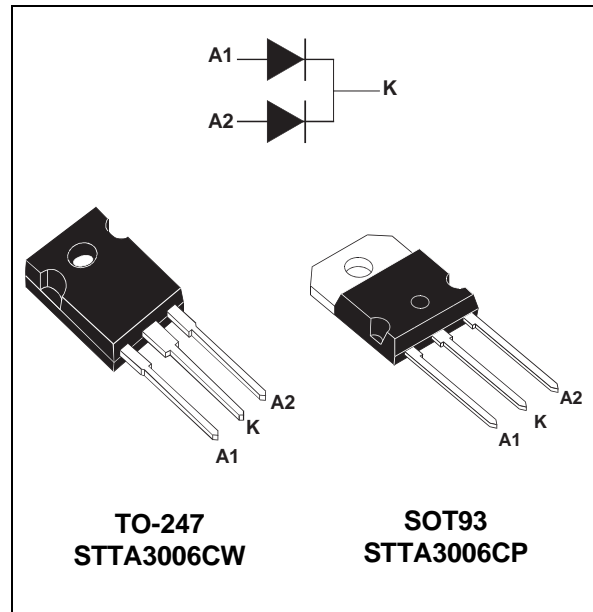

DESCRIPTION

The TURBOSWITCH is a very high performance series of ultra-fast high voltage power diodes from 600V to 1200V.

TURBOSWITCH family, drastically cuts losses in both the diode and the associated switching IGBT or MOSFET in all "freewheel mode" operations and is particularly suitable and efficient in motor

control freewheel applications and in booster diode applications in power factor control circuitries. Packaged either in TO-247 or SOT93, these 600V devices are particularly intended for use on 240V domestic mains.

ABSOLUTE RATINGS (limiting values, per diode)

| Symbol | Parameter | | Value | Unit |
|--------------|--|-----------------------------------|------------|------|
| V_{RRM} | Repetitive peak reverse voltage | | 600 | V |
| V_{RSM} | Non repetitive peak reverse voltage | | 600 | V |
| $I_{F(RMS)}$ | RMS forward current | | 30 | A |
| I_{FRM} | Repetitive peak forward current | $t_p = 5 \mu s$ $F = 5kHz$ square | 200 | A |
| I_{FSM} | Surge non repetitive forward current | $t_p = 10 ms$ sinusoidal | 230 | A |
| T_j | Maximum operating junction temperature | | 150 | °C |
| T_{stg} | Storage temperature range | | -65 to 150 | °C |

TM : TURBOSWITCH is a trademark of STMicroelectronics

STTA3006CW/CP

THERMAL AND POWER DATA

| Symbol | Parameter | Test conditions | Value | Unit |
|---------------|---|--|-------|------|
| $R_{th(j-c)}$ | Junction to case | Per diode | 1.9 | °C/W |
| | | Total | 1.0 | |
| | | Coupling | 0.1 | |
| P_1 | Conduction power dissipation | Per diode $I_{F(AV)} = 30A$ $\delta = 0.5$ $T_C = 110^\circ C$ | 20.5 | W |
| P_{max} | Total power dissipation $P_{max} = P_1 + P_3$ ($P_3 = 10\% P_1$) | Per diode $T_C = 105^\circ C$ | 22.5 | W |

STATIC ELECTRICAL CHARACTERISTICS (per diode)

| Symbol | Parameter | Test conditions | Min | Typ | Max | Unit |
|------------|-------------------------|---|-----|-----|------|------------|
| V_F^* | Forward voltage drop | $I_F = 15A$ $T_j = 25^\circ C$ $T_j = 125^\circ C$ | | | 1.8 | V |
| | | | | 1.3 | 1.6 | V |
| I_R^{**} | Reverse leakage current | $V_R = 0.8 \times V_{RRM}$ $T_j = 25^\circ C$ $T_j = 125^\circ C$ | | | 100 | μA |
| | | | | 2 | 5 | mA |
| V_{to} | Threshold voltage | $I_p < 3 \cdot I_{AV}$ $T_j = 125^\circ C$ | | | 1.06 | V |
| r_d | Dynamic resistance | | | | 177 | m Ω |

Test pulse : * $t_p = 380 \mu s$, $\delta < 2\%$

** $t_p = 5 ms$, $\delta < 2\%$

To evaluate the maximum conduction losses use the following equation :

$$P = V_{to} \times I_{F(AV)} + r_d \times I_F^2(RMS)$$

DYNAMIC ELECTRICAL CHARACTERISTICS (per diode)

TURN-OFF SWITCHING

| Symbol | Parameter | Test conditions | Min | Typ | Max | Unit |
|----------|----------------------------------|--|-----|------|------|------|
| t_{rr} | Reverse recovery time | $T_j = 25^\circ C$ $I_F = 0.5 A$ $I_R = 1A$ $I_{rr} = 0.25A$ $I_F = 1A$ $dl_F/dt = -50A/\mu s$ $V_R = 30V$ | | 35 | 65 | ns |
| I_{RM} | Maximum reverse recovery current | $T_j = 125^\circ C$ $V_R = 400V$ $I_F = 15A$ $dl_F/dt = -120 A/\mu s$ $dl_F/dt = -500 A/\mu s$ | | 17.5 | 12.5 | A |
| S factor | Softness factor | $T_j = 125^\circ C$ $V_R = 400V$ $I_F = 15A$ $dl_F/dt = -500 A/\mu s$ | | 0.5 | | / |

TURN-ON SWITCHING

| Symbol | Parameter | Test conditions | Min | Typ | Max | Unit |
|----------|-----------------------|---|-----|-----|-----|------|
| t_{fr} | Forward recovery time | $T_j = 25^\circ C$ $I_F = 15A$, $dl_F/dt = 120 A/\mu s$ measured at, $1.1 \times V_{Fmax}$ | | | 500 | ns |
| V_{Fp} | Peak forward voltage | $T_j = 25^\circ C$ $I_F = 15A$, $dl_F/dt = 120 A/\mu s$ | | | 9 | V |

Fig. 1: Conduction losses versus average current.

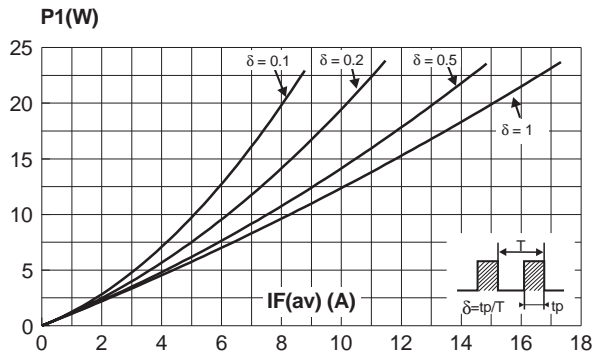

Fig. 2: Forward voltage drop versus forward current (maximum values).

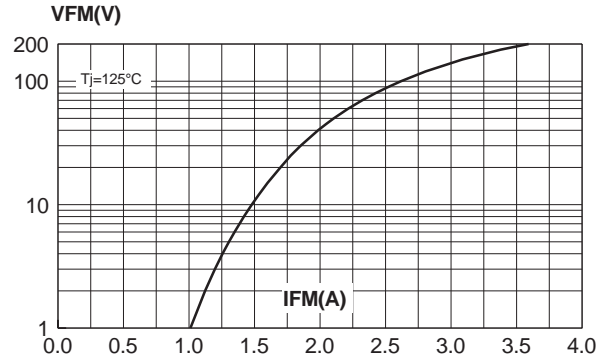

Fig. 3: Relative variation of thermal transient impedance junction to case versus pulse duration.

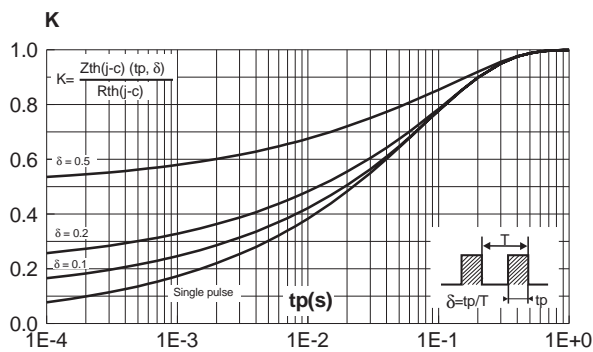

Fig. 4: Peak reverse recovery current versus dIF/dt (90% confidence).

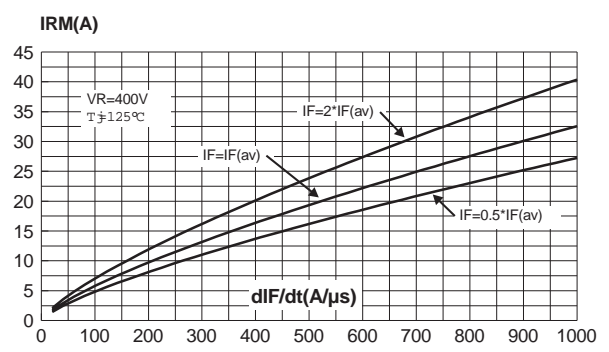

Fig. 5: Reverse recovery time versus dIF/dt (90% confidence).

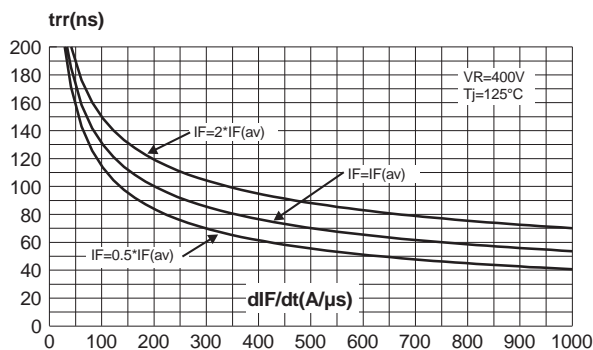

Fig. 6: Softness factor (tb/ta) versus dIF/dt (typical values).

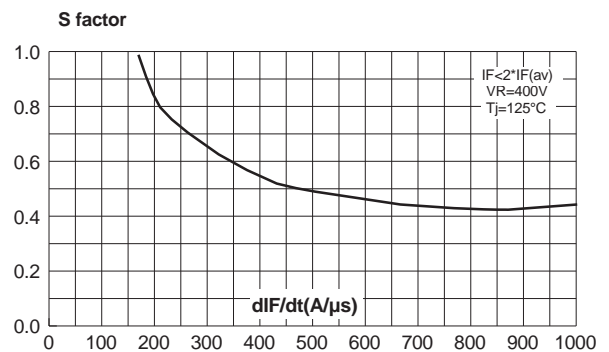

Fig. 7: Relative variation of dynamic parameters versus junction temperature (reference $T_j=125^\circ\text{C}$).

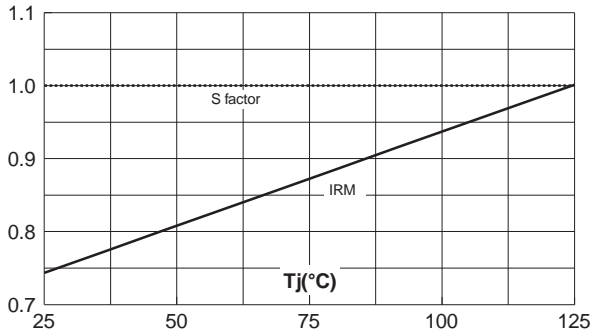

Fig. 8: Transient peak forward voltage versus dI_F/dt (90% confidence).

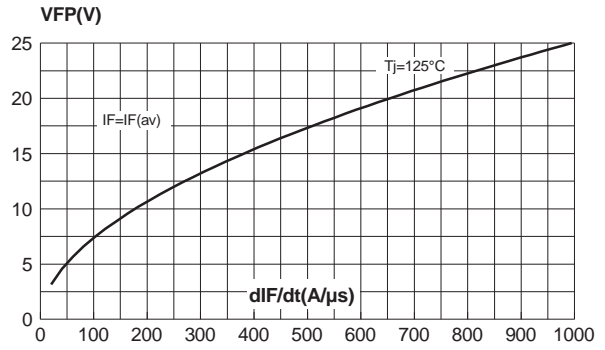
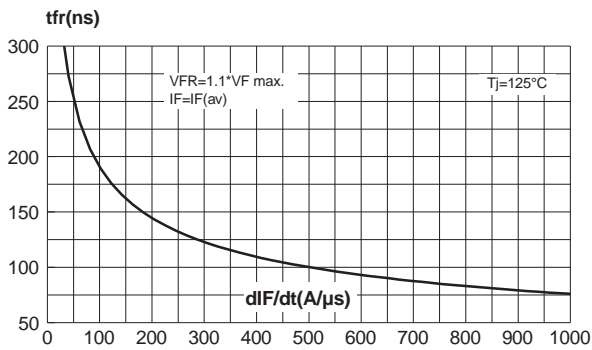

Fig. 9: Forward recovery time versus dI_F/dt (90% confidence).



APPLICATION DATA

The TURBOSWITCH is especially designed to provide the lowest overall power losses in any "FREEWHEEL Mode" application (Fig.A) considering both the diode and the companion

transistor, thus optimizing the overall performance in the end application.

The way of calculating the power losses is given below:

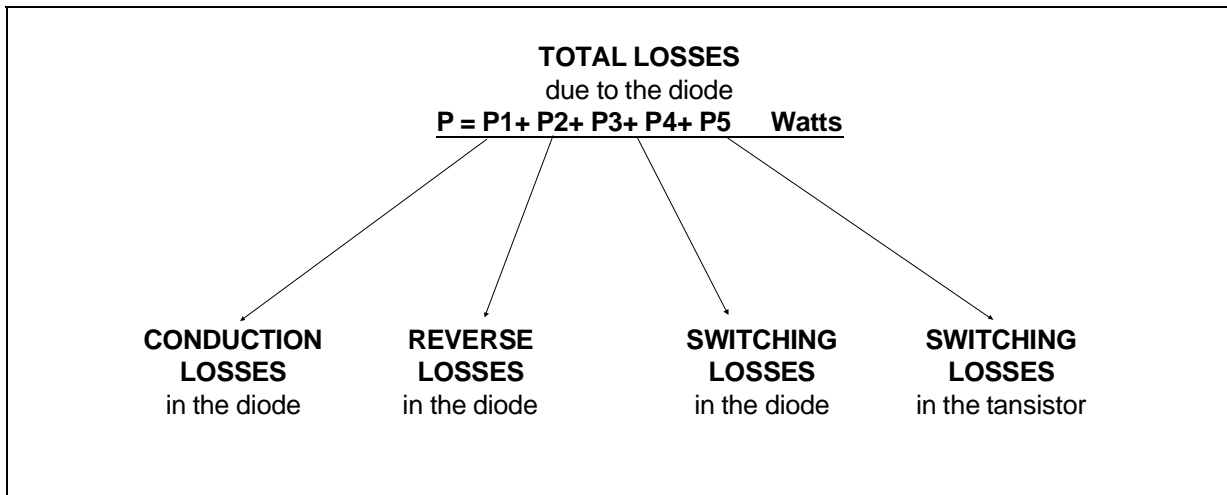
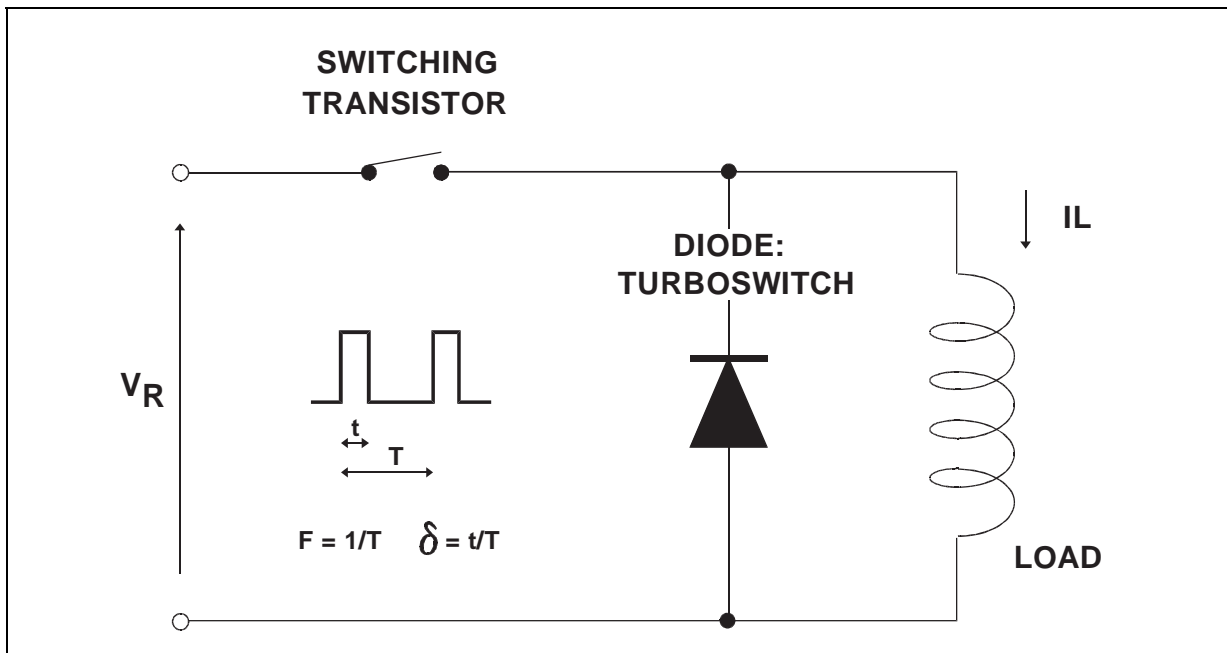
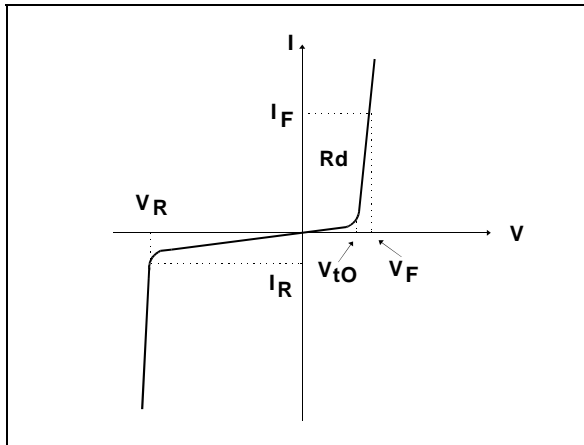

Fig. A : "FREEWHEEL" MODE.



APPLICATION DATA (Cont'd)

Fig. B: STATIC CHARACTERISTICS



Conduction losses :

$$P1 = V_{t0} \cdot I_{F(AV)} + R_d \cdot I_F^2(RMS)$$

Reverse losses :

$$P2 = V_R \cdot I_R \cdot (1 - \delta)$$

Fig. C: TURN-OFF CHARACTERISTICS

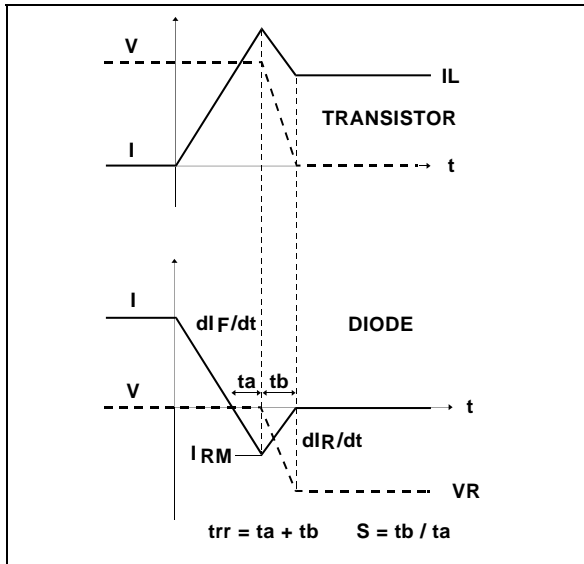

Turn-on losses :

(in the transistor, due to the diode)

$$P5 = \frac{V_R \times I_{RM}^2 \times (3 + 2 \times S) \times F}{6 \times dI_F/dt} + \frac{V_R \times I_{RM} \times I_L \times (S + 2) \times F}{2 \times dI_F/dt}$$

Turn-off losses (in the diode) :

$$P3 = \frac{V_R \times I_{RM}^2 \times S \times F}{6 \times dI_F/dt}$$

P3 and P5 are suitable for power MOSFET and IGBT

Fig. C: TURN-ON CHARACTERISTICS

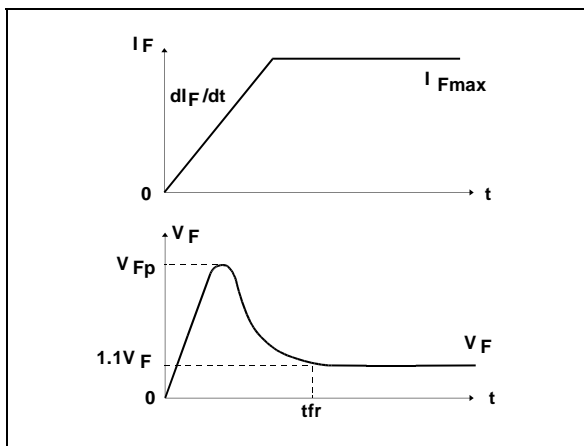

Turn-on losses :

$$P4 = 0.4 (V_{FP} - V_F) \cdot I_{Fmax} \cdot F$$

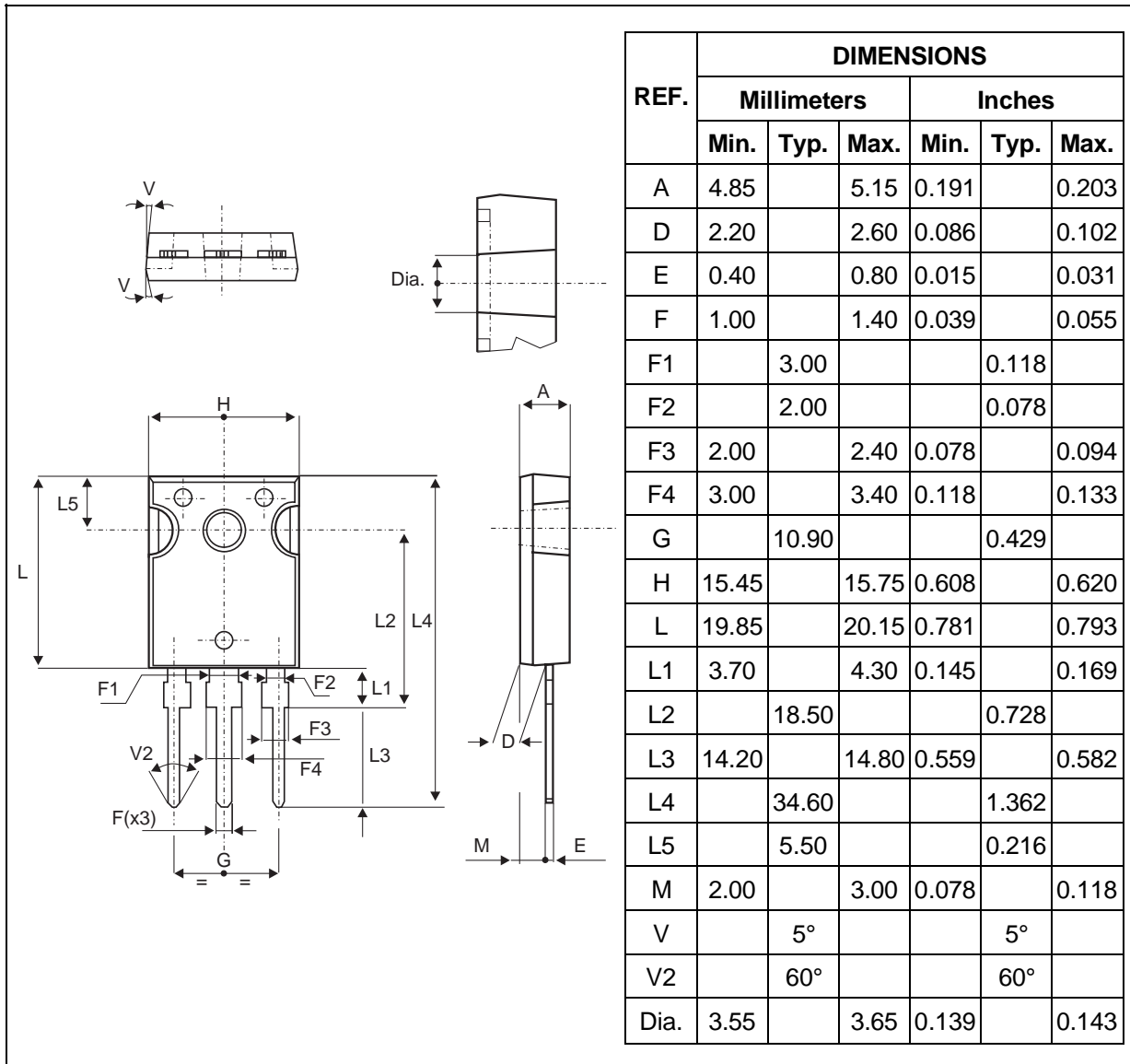
PACKAGE DATA
 TO-247 Plastic

- Cooling method : by conduction (C).
- Recommended torque value : 0.8 m.N
- Maximum torque value : 1 m.N

STTA3006CW/CP

PACKAGE DATA

SOT93 Plastic

| REF. | DIMENSIONS | | | | | |
|------|-------------|-------|-------|--------|-------|-------|
| | Millimeters | | | Inches | | |
| | Min. | Typ. | Max. | Min. | Typ. | Max. |
| A | 4.70 | | 4.90 | 1.185 | | 0.193 |
| C | 1.90 | | 2.10 | 0.075 | | 0.083 |
| D | | 2.50 | | | 0.098 | |
| D1 | | 2.00 | | | 0.078 | |
| E | 0.50 | | 0.78 | 0.020 | | 0.031 |
| F | 1.10 | | 1.30 | 0.043 | | 0.051 |
| F3 | | 1.75 | | | 0.069 | |
| F4 | | 2.10 | | | 0.083 | |
| G | 10.80 | | 11.10 | 0.425 | | 0.437 |
| H | 14.70 | | 15.20 | 0.279 | | 0.598 |
| L | | | 12.20 | | | 0.480 |
| L2 | | | 16.20 | | | 0.638 |
| L3 | | 18.0 | | | 0.709 | |
| L5 | 3.95 | | 4.15 | 0.156 | | 0.163 |
| L6 | | 31.00 | | | 1.220 | |
| O | 4.00 | | 4.10 | 0.157 | | 0.161 |

- Cooling method : by conduction (C).
- Recommended torque value : 0.8 m.N
- Maximum torque value : 1 m.N

| Ordering type | Marking | Package | Weight | Base qty | Delivery mode |
|---------------|------------|---------|--------|----------|---------------|
| STTA3006CW | STTA3006CW | TO247 | 4.36g | 30 | Tube |
| STTA3006CP | STTA3006CP | SOT93 | 3.97g | 30 | Tube |

- Epoxy meets UL94,V0

Information furnished is believed to be accurate and reliable. However, STMicroelectronics assumes no responsibility for the consequences of use of such information nor for any infringement of patents or other rights of third parties which may result from its use. No license is granted by implication or otherwise under any patent or patent rights of STMicroelectronics. Specifications mentioned in this publication are subject to change without notice. This publication supersedes and replaces all information previously supplied. STMicroelectronics products are not authorized for use as critical components in life support devices or systems without express written approval of STMicroelectronics.

The ST logo is a registered trademark of STMicroelectronics

© 1999 STMicroelectronics - Printed in Italy - All rights reserved.

STMicroelectronics GROUP OF COMPANIES

Australia - Brazil - China - Finland - France - Germany - Hong Kong - India - Italy - Japan - Malaysia
Malta - Morocco - Singapore - Spain - Sweden - Switzerland - United Kingdom - U.S.A.

<http://www.st.com>