

FEATURES

- **HIGH GAIN BANDWIDTH PRODUCT:**
 $f_T = 8.5 \text{ GHz TYP}$
- **HIGH SPEED SWITCHING CHARACTERISTICS**
- **NPN COMPLIMENT AVAILABLE:** NE68133
- **HIGH INSERTION POWER GAIN:**
 $|S_{21E}|^2 = 12 \text{ dB at } 1 \text{ GHz}$

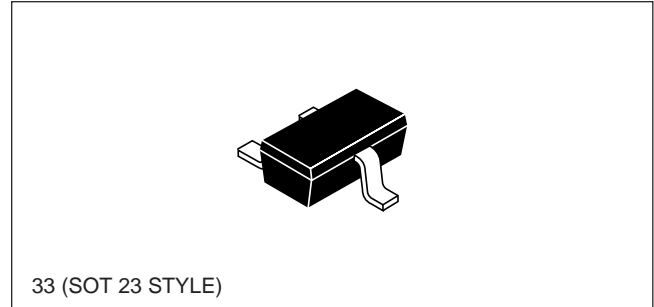

DESCRIPTION

The NE97733 PNP silicon transistor is designed for ultrahigh speed current mode switching applications and microwave amplifiers up to 3.5 GHz. The NE97733 offers excellent performance and reliability at low cost.

ELECTRICAL CHARACTERISTICS ($T_A = 25^\circ\text{C}$)

PART NUMBER EIAJ ¹ REGISTERED NUMBER PACKAGE OUTLINE			NE97733 2SA1977 33		
SYMBOLS	PARAMETERS AND CONDITIONS	UNITS	MIN	TYP	MAX
f_T	Gain Bandwidth Product at $V_{CE} = -8 \text{ V}$, $I_C = -20 \text{ mA}$	GHz	6.0	8.5	
NF	Noise Figure at $V_{CE} = -8 \text{ V}$, $I_C = -3 \text{ mA}$	dB		1.5	3.0
$ S_{21E} ^2$	Insertion Power Gain at $V_{CE} = -8 \text{ V}$, $I_C = -20 \text{ mA}$, $f = 1 \text{ GHz}$	dB	8.0	12.0	
h_{FE}	Forward Current Gain Ratio at $V_{CE} = -8 \text{ V}$, $I_C = -20 \text{ mA}$		20	40	100
I_{CBO}	Collector Cutoff Current at $V_{CB} = -10 \text{ V}$, $I_E = 0$	μA			-0.1
I_{EBO}	Emitter Cutoff Current at $V_{BE} = -1 \text{ V}$, $I_C = 0$	μA			-0.1
C_{RE}^2	Feedback Capacitance at $V_{CB} = -10 \text{ V}$, $I_E = 0 \text{ mA}$, $f = 1 \text{ MHz}$	pF		0.5	0.1
P_T	Total Power Dissipation	mW			200

Notes:

1. Electronic Industrial Association of Japan.
2. Capacitance is measured with emitter and case connected to the guard terminal at the bridge.

ABSOLUTE MAXIMUM RATINGS¹ ($T_A = 25^\circ\text{C}$)

SYMBOLS	PARAMETERS	UNITS	RATINGS
V _{CBO}	Collector to Base Voltage	V	-20
V _{CEO}	Collector to Emitter Voltage	V	-12
V _{EBO}	Emitter to Base Voltage	V	-3
I _C	Collector Current	mA	-50
T _J	Junction Temperature	°C	150
T _{STG}	Storage Temperature	°C	-65 to +200

Note:

1. Operation in excess of any one of these parameters may result in permanent damage.

DC CURRENT GAIN vs. COLLECTOR CURRENT

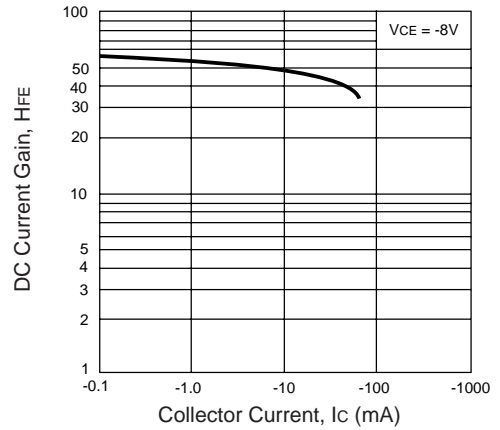

TYPICAL PERFORMANCE CURVES ($T_A = 25^\circ\text{C}$)

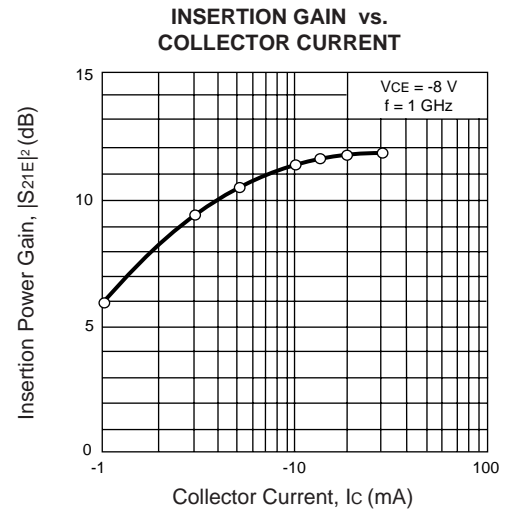
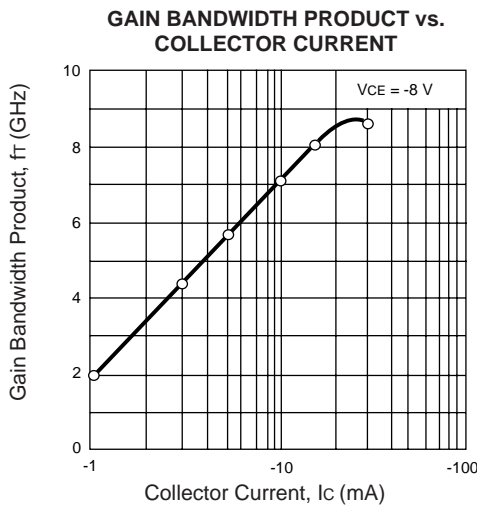
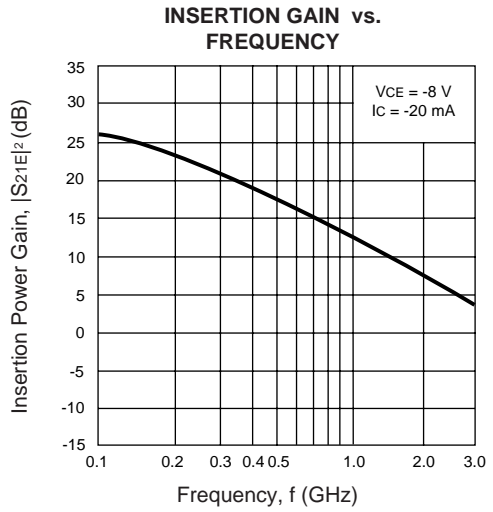
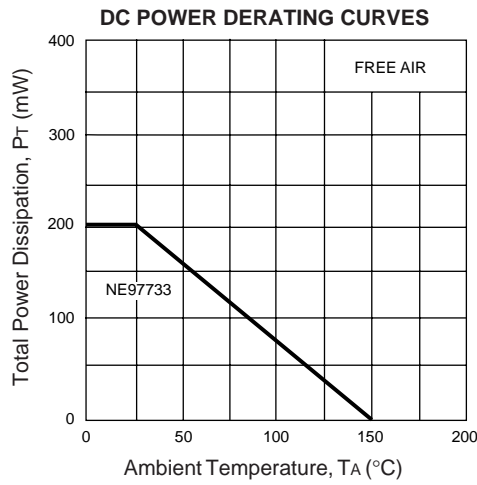

TYPICAL PERFORMANCE CURVES ($T_A = 25^\circ\text{C}$)

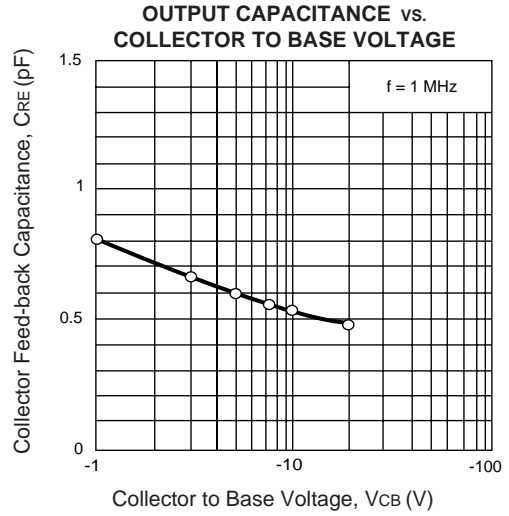
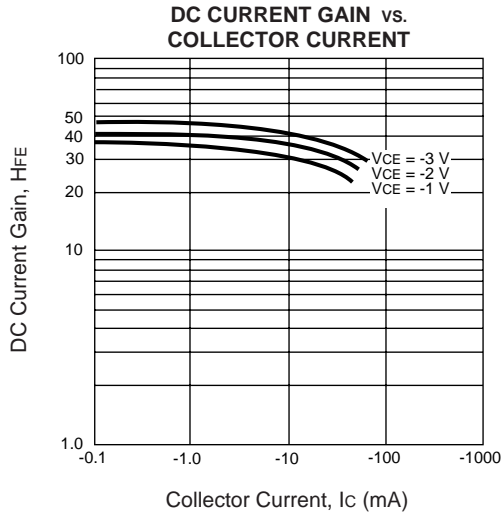

SWITCHING CHARACTERISTICS

Parameter	Symbol	$V_{in} = 1\text{ V}$	Unit
		TYP	
Turn-on Delay Time	t_{ON} (delay)	1.08	ns
Rise Time	t_r	0.66	ns
Turn-off Delay Time	t_{OFF} (delay)	0.32	ns
Fall Time	t_f	0.78	ns

SWITCHING TIME MEASUREMENT CIRCUIT

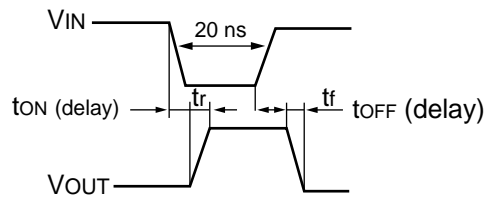
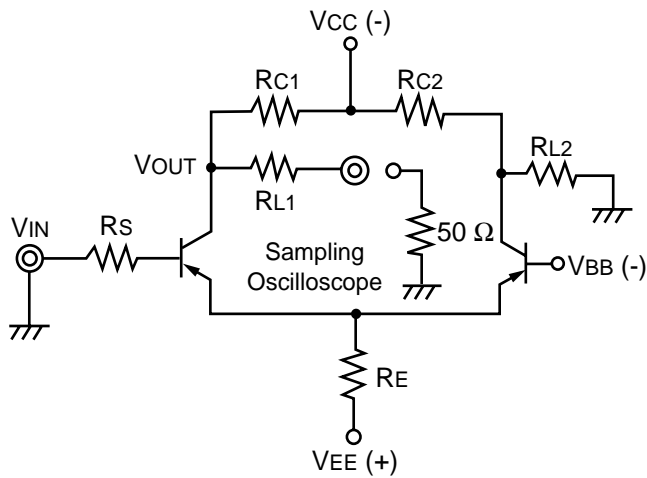

$V_{in} = 1\text{ V}, V_{BB} = -0.5\text{ V}, R_{c1} = R_{c2}$						
R_s (Ω)	R_c (Ω)	R_{L1} (Ω)	R_{L2} (Ω)	R_E (Ω)	V_{EE} (V)	V_{CC} (V)
160	1 K	200	250	2.7 K	27	26.3

TYPICAL SCATTERING PARAMETERS (T_A = 25°C)

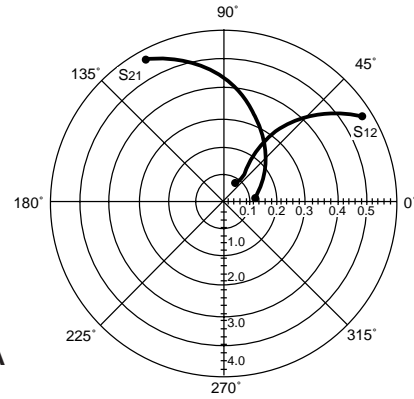
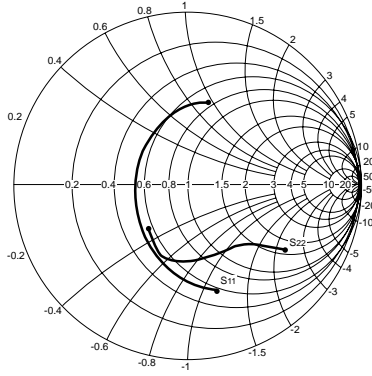

97733
VCE = -8 V, IC = -3 mA

VCE = -1 V, IC = -5 mA

FREQUENCY (GHz)	S11		S21		S12		S22		K	MAG ¹ (dB)
	MAG	ANG	MAG	ANG	MAG	ANG	MAG	ANG		
0.50	0.428	-126.3	4.899	100.7	0.101	52.7	0.417	-54.0	0.77	16.8
0.80	0.382	-160.6	3.398	82.8	0.132	54.1	0.309	-60.2	0.97	14.1
1.00	0.374	-175.9	2.813	74.1	0.154	55.0	0.272	-64.5	1.04	11.5
1.50	0.387	155.1	2.002	56.8	0.213	54.6	0.230	-80.1	1.09	7.9
2.00	0.419	132.6	1.583	42.6	0.274	51.3	0.226	-100.1	1.07	6.0
2.50	0.461	114.5	1.323	30.6	0.336	46.5	0.247	-119.0	1.04	4.8
3.00	0.502	100.2	1.148	21.0	0.393	40.9	0.270	-133.8	1.01	4.1
4.00	0.552	82.6	0.948	7.0	0.501	29.4	0.267	-159.3	0.98	2.8
5.00	0.574	74.2	0.859	-4.4	0.599	16.0	0.218	155.9	0.98	1.6

VCE = -5 V, IC = -10 mA

0.50	0.251	-126.4	7.121	99.1	0.072	67.8	0.426	-38.9	0.91	19.9
0.80	0.213	-159.9	4.739	84.5	0.107	68.2	0.350	-39.9	1.00	16.0
1.00	0.207	-176.4	3.878	77.3	0.131	67.6	0.324	-41.9	1.03	13.7
1.50	0.225	151.5	2.708	62.5	0.191	64.2	0.288	-52.1	1.04	10.3
2.00	0.265	127.7	2.116	49.8	0.252	59.4	0.272	-67.9	1.03	8.2
2.50	0.316	109.8	1.754	38.6	0.310	53.5	0.275	-85.3	1.00	7.2
3.00	0.365	96.8	1.511	28.8	0.364	47.5	0.284	-100.1	0.98	6.2
4.00	0.428	82.3	1.218	13.5	0.467	36.4	0.269	-121.5	0.95	4.2
5.00	0.462	77.7	1.074	0.8	0.566	24.3	0.171	-148.4	0.94	2.8

VCE = -8 V, IC = -3 mA

0.50	0.626	-74.0	4.205	119.4	0.088	54.6	0.673	-32.7	0.56	16.8
0.80	0.447	-111.0	3.520	97.8	0.109	51.8	0.558	-38.2	0.79	15.1
1.00	0.374	-131.4	3.075	87.0	0.122	52.6	0.512	-41.0	0.91	14.0
1.50	0.302	-174.7	2.293	67.2	0.157	56.0	0.451	-49.9	1.05	10.2
2.00	0.310	151.1	1.824	51.9	0.202	57.8	0.427	-62.0	1.06	8.0
2.50	0.355	125.4	1.516	39.0	0.256	56.7	0.425	-76.0	1.01	7.0
3.00	0.407	106.9	1.301	28.4	0.314	53.7	0.433	-89.1	0.96	6.2
4.00	0.428	85.0	1.038	13.9	0.438	44.7	0.425	-110.2	0.90	3.7
5.00	0.503	74.6	0.930	3.7	0.573	32.3	0.328	-133.5	0.91	2.1

VCE = -8 V, IC = -20 mA

0.50	0.151	-140.9	8.095	95.5	0.067	74.7	0.389	-34.1	0.98	20.8
0.80	0.140	-172.1	5.268	83.1	0.105	73.5	0.334	-34.1	1.02	16.2
1.00	0.142	172.1	4.288	76.7	0.129	72.2	0.315	-36.1	1.03	14.1
1.50	0.170	141.7	2.974	63.2	0.191	66.9	0.285	-46.2	1.03	10.9
2.00	0.215	119.7	2.317	51.4	0.252	60.8	0.269	-61.6	1.02	8.9
2.50	0.268	104.0	1.918	40.7	0.309	54.6	0.268	-79.2	1.00	7.9
3.00	0.318	92.5	1.652	31.2	0.362	48.4	0.274	-94.3	0.98	6.6
4.00	0.379	80.9	1.332	15.8	0.459	36.9	0.257	-114.2	0.95	4.6
5.00	0.416	79.2	1.169	2.6	0.552	25.3	0.154	-134.6	0.94	3.3

Note:

1. Gain Calculation:

$$MAG = \frac{|S_{21}|}{|S_{12}|} (K \pm \sqrt{K^2 - 1})$$

When K ≤ 1, MAG is undefined and MSG values are used. $MSG = \frac{|S_{21}|}{|S_{12}|}$, $K = \frac{1 + |\Delta|^2 - |S_{11}|^2 - |S_{22}|^2}{2 |S_{12} S_{21}|}$, $\Delta = S_{11} S_{22} - S_{21} S_{12}$

MAG = Maximum Available Gain

MSG = Maximum Stable Gain

OUTLINE DIMENSIONS (Units in mm)

PACKAGE OUTLINE 33
(SOT-23)

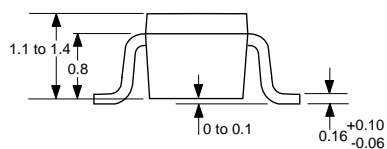
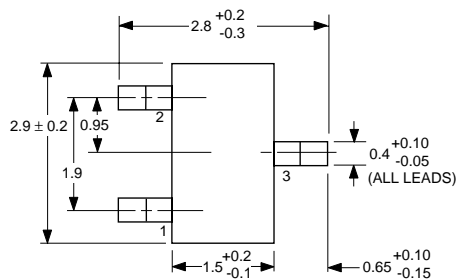

PIN CONNECTIONS
 1. Emitter
 2. Base
 3. Collector

OUTLINE 33
RECOMMENDED P.C.B. LAYOUT

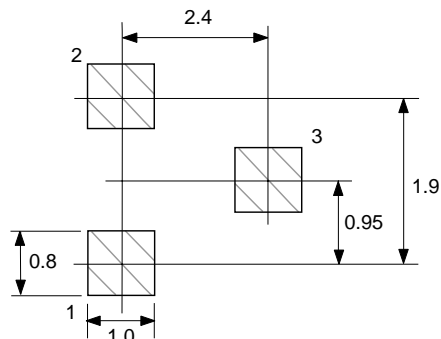

ORDERING INFORMATION

PART NUMBER	QUANTITY	PACKAGING
NE97733-T1	3000	Tape & Reel

EXCLUSIVE NORTH AMERICAN AGENT FOR **NEC** RF, MICROWAVE & OPTOELECTRONIC SEMICONDUCTORS

CEL CALIFORNIA EASTERN LABORATORIES • Headquarters • 4590 Patrick Henry Drive • Santa Clara, CA 95054-1817 • (408) 988-3500 • Telex 34-6393 • FAX (408) 988-0279
 24-Hour Fax-On-Demand: 800-390-3232 (U.S. and Canada only) • Internet: <http://WWW.CEL.COM>

DATA SUBJECT TO CHANGE WITHOUT NOTICE

PRINTED IN USA ON RECYCLED PAPER -7/98