MSM6882-3/6882-5

2400/1200 bps Single Chip MSK Modem

GENERAL DESCRIPTION

The MSM6882-3/6882-5 is a single chip MSK (Minimum Shift Keying) modem which is fabricated by Oki's low power consumption CMOS silicon gate technology.

The demodulator receives the data to be transmitted (SD) synchronized with the transmit timing clock (ST) generated by the on-chip clock generator. The signal, which is modulated by MSK method, is output.

The demodulator converts the received MSK signal to the received data (RD) by means of a delay detection technique after limiting the band of the received MSK signal. This signal is input to the digital PLL and the re-generated timing clock (RT) is output from the demodulator, synchronized with the RD.

FEATURES

- Signal power supply: +3.6 V (MSM6882-3)
+5 V (MSM6882-5)
- On-chip SCF (Switched Capacitor Filter)
- The transmit filter can be also used as voice splatter filter.
- The receive timing re-generator has two different lock-in time performance options to be chosen from.
- Bit rate 2400/1200 bps
- CCIR Rec. 623
- The modulation method can be selected from COS-FFSK and SIN-FFSK.
- Built-in crystal oscillation circuit.
- Package options:

22-pin plastic DIP	(DIP22-P-400-2.54)	(Product name: MSM6882-3RS)
		(Product name: MSM6882-5RS)
24-pin plastic SOP	(SOP24-P-430-1.27-K)	(Product name: MSM6882-3GS-K)
		(Product name: MSM6882-5GS-K)

BLOCK DIAGRAM

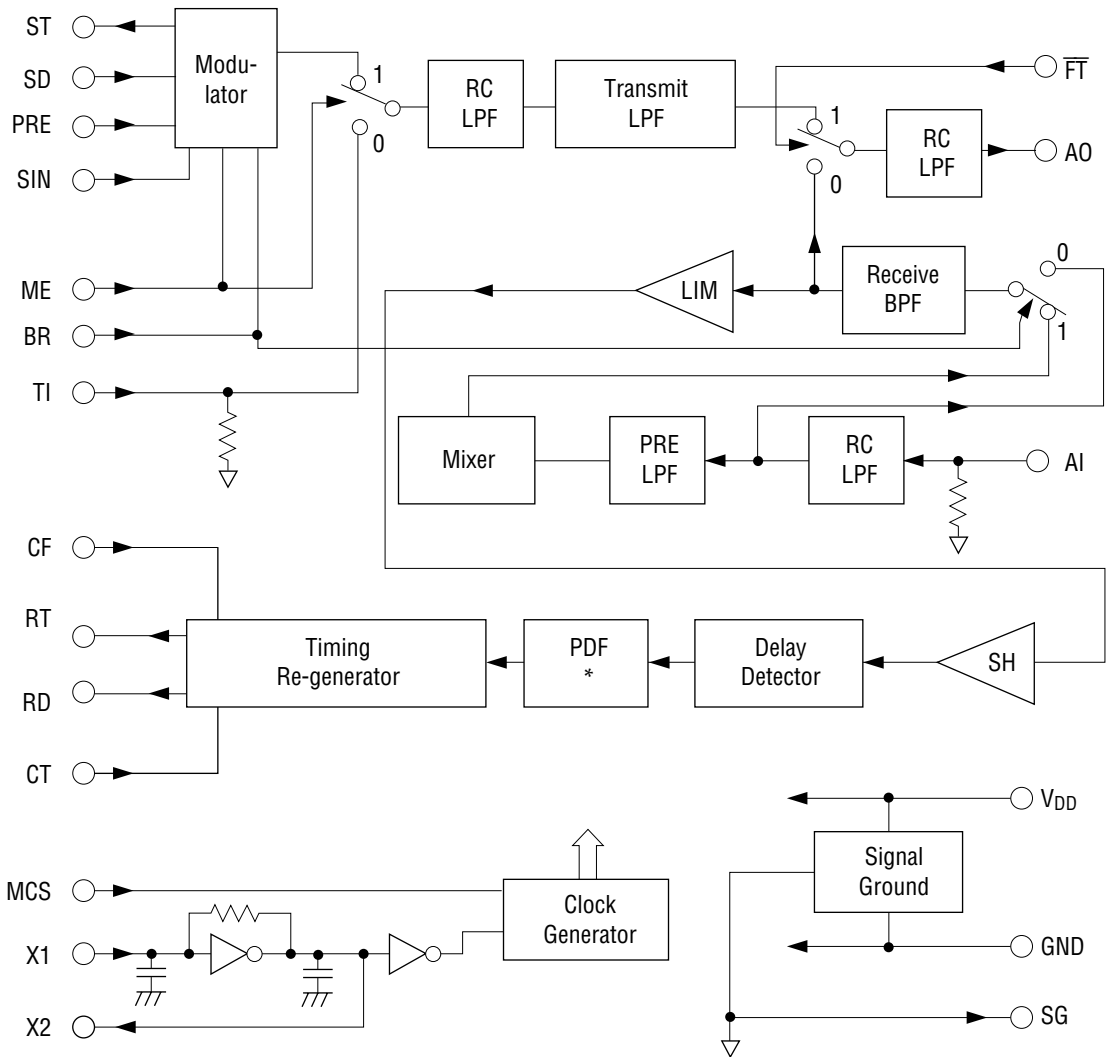

* Post Detection Filter

PIN CONFIGURATION (TOP VIEW)

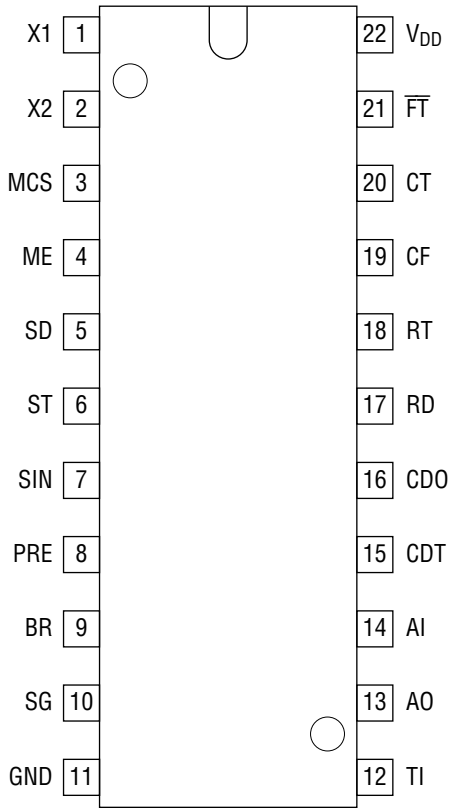



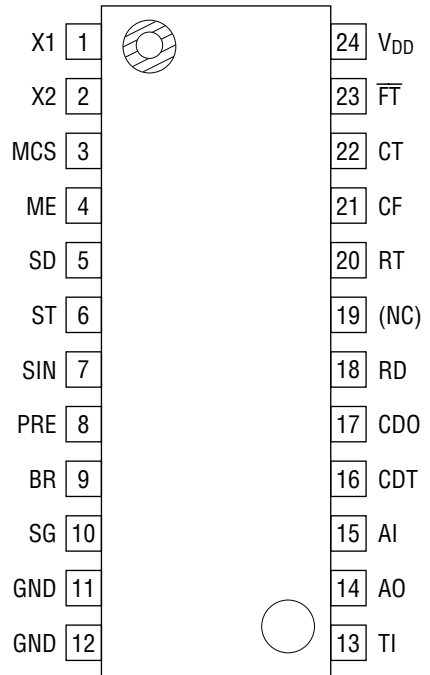







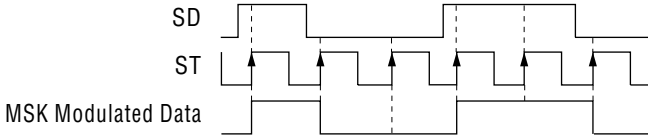

























22-Pin Plastic DIP



24-Pin Plastic SOP

NC : No connect pin

PIN DESCRIPTION

Name	Description													
X1	Crystal connection pins. A 3.6864 MHz or 7.3728 MHz crystal shall be connected.													
X2	When an external clock is applied for MSM6882's oscillation source, it has to be input to X2. In this case, X2 has to be AC-coupled by the capacitor of 200 pF. X1 shall be left open.													
MCS	Master clock selection.													
	<table border="1" data-bbox="347 450 684 484"> <tr> <td>MCS</td> <td>Crystal or External Clock</td> </tr> </table>	MCS	Crystal or External Clock											
	MCS	Crystal or External Clock												
	<table border="1" data-bbox="347 484 684 527"> <tr> <td>0</td> <td>3.6864 MHz</td> </tr> </table>	0	3.6864 MHz											
0	3.6864 MHz													
<table border="1" data-bbox="347 527 684 569"> <tr> <td>1</td> <td>7.3728 MHz</td> </tr> </table>	1	7.3728 MHz												
1	7.3728 MHz													
ME	Modulator enable. When a "high" is input on this pin, MSK modulator output is connected to the input of transmit LPF. When a "low" is input on this pin, TI is connected to the input of transmit LPF.													
SD	Send data input. The data on this pin is synchronized with the rising edge of ST and input to MSK modulator as an actual transmit data. 													
ST	This timing signal is used to latch serial input data on the SD pin. The frequency of ST coincides with the transmission bit rate.													
SIN	Modulation method selection. Data put on this pin selects either SINE FAST FSK or COSINE FAST FSK.													
	<table border="1" data-bbox="326 1108 1230 1180"> <tr> <td>Data (2400 bps)</td> <td>0</td> <td>1</td> <td>0</td> <td>0</td> <td>1</td> <td>1</td> </tr> </table>	Data (2400 bps)	0	1	0	0	1	1						
	Data (2400 bps)	0	1	0	0	1	1							
<table border="1" data-bbox="326 1180 1230 1325"> <tr> <td>Sine Fast FSK</td> <td></td> <td></td> <td></td> <td></td> <td></td> <td></td> </tr> <tr> <td>Cosine Fast FSK</td> <td></td> <td></td> <td></td> <td></td> <td></td> <td></td> </tr> </table>	Sine Fast FSK							Cosine Fast FSK						
Sine Fast FSK														
Cosine Fast FSK														
PRE	Preamble or data transmission selection. When a "low" is input on this pin, the data put on the SD pin is output on the AO pin. When a "high" is input on this pin, the data put on the SD pin is neglected and preamble data is output. Data put on PRE is latched on the rising edge of ST. Preamble means to modulate as 010101...pattern.													

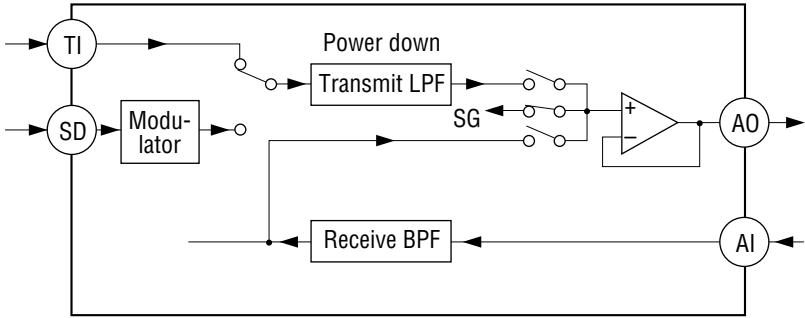
Name	Description																																				
BR	<p>Baud rate selection.</p> <table border="1" data-bbox="367 324 1090 587"> <thead> <tr> <th rowspan="2">Master Clock (MHz)</th> <th rowspan="2">MCS</th> <th rowspan="2">BR</th> <th rowspan="2">Bit Rate (bps)</th> <th colspan="2">Carrier Freq. (Hz)</th> </tr> <tr> <th>Mark</th> <th>Space</th> </tr> </thead> <tbody> <tr> <td rowspan="2">7.3728</td> <td>1</td> <td>1</td> <td>2400</td> <td>1200</td> <td>2400</td> </tr> <tr> <td>1</td> <td>0</td> <td>1200</td> <td>1200</td> <td>1800</td> </tr> <tr> <td>3.6864</td> <td>0</td> <td>0</td> <td>1200</td> <td>1200</td> <td>1800</td> </tr> <tr> <td rowspan="2">3.6864</td> <td>1</td> <td>1</td> <td>1200</td> <td>600</td> <td>1200</td> </tr> <tr> <td>1</td> <td>0</td> <td>600</td> <td>600</td> <td>900</td> </tr> </tbody> </table>	Master Clock (MHz)	MCS	BR	Bit Rate (bps)	Carrier Freq. (Hz)		Mark	Space	7.3728	1	1	2400	1200	2400	1	0	1200	1200	1800	3.6864	0	0	1200	1200	1800	3.6864	1	1	1200	600	1200	1	0	600	600	900
Master Clock (MHz)	MCS					BR	Bit Rate (bps)	Carrier Freq. (Hz)																													
		Mark	Space																																		
7.3728	1	1	2400	1200	2400																																
	1	0	1200	1200	1800																																
3.6864	0	0	1200	1200	1800																																
3.6864	1	1	1200	600	1200																																
	1	0	600	600	900																																
SG	<p>Built-in analog signal ground. The DC voltage is approximately half of V_{DD}, so the analog interfaces signals of AI, AO, and TI with peripheral circuits which must be implemented by AC-coupling. To make this voltage source impedance lower and ensure the device performance of this device, more than 0.1 μF bypass capacitors should be connected from SG to GND and from SG to V_{DD}.</p>																																				
GND	<p>Ground. (0 V)</p>																																				
TI	<p>Voice signal input. The signal input to this pin can be sent out to AO through the transmit LPF, the characteristics of which, gives the splatter filter for voice band signal. When this function is used, digital "0" must be input to ME. TI is biased to SG through internal resistor.</p>																																				
AO	<p>Transmit analog signal output. The data put on ME and \overline{FT} can set the status of AO as follows.</p> <table border="1" data-bbox="353 1062 1123 1251"> <thead> <tr> <th>\overline{FT}</th> <th>ME</th> <th>Transmit LPF</th> <th>State of AO</th> </tr> </thead> <tbody> <tr> <td>"1"</td> <td>"1"</td> <td rowspan="2">Power On</td> <td>MSK Signal</td> </tr> <tr> <td>"1"</td> <td>"0"</td> <td>Voice Signal</td> </tr> <tr> <td>"0"</td> <td>"1"</td> <td rowspan="2">Power Down</td> <td>The Output of Receive BPF</td> </tr> <tr> <td>"0"</td> <td>"0"</td> <td>No-signal (SG level)</td> </tr> </tbody> </table>  <p>The state when \overline{FT} and ME = "0" is shown above. When the input digital data on \overline{FT} changes to "1" from "0", AO remains to be connected to SG during about 2 ms and after that, and AO is switched to transmit LPF. This delay time prevents AO from outputting meaningless signal during transient time from power down to on of LPF.</p>	\overline{FT}	ME	Transmit LPF	State of AO	"1"	"1"	Power On	MSK Signal	"1"	"0"	Voice Signal	"0"	"1"	Power Down	The Output of Receive BPF	"0"	"0"	No-signal (SG level)																		
\overline{FT}	ME	Transmit LPF	State of AO																																		
"1"	"1"	Power On	MSK Signal																																		
"1"	"0"		Voice Signal																																		
"0"	"1"	Power Down	The Output of Receive BPF																																		
"0"	"0"		No-signal (SG level)																																		

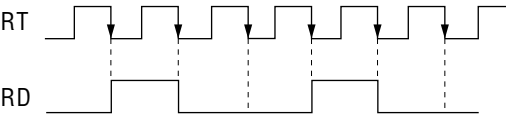
Name	Description																	
AI	Receive analog signal input. AI is biased internally to SG with about 100 kΩ same as TI.																	
CDT	Device test. This pin should be connected to GND.																	
CDO	Device test. This pin should be opened.																	
RD	Demodulated serial data output. This data is synchronized with the re-generated timing clock RT.																	
RT	<p>Receive data timing clock output. This signal is re-generated by internal digital PLL. Synchronizing to negative edge of RT, RD is output.</p> 																	
CF	<p>Receive data timing clock is re-generated by digital PLL of which phase correcting speed can be selected with CF. When a digital "1" is put on CF and phase difference between receive data timing and RT is more than 22.5 degree, phase correcting speed is high. In this case, as the phase difference enters within 22.5 degrees, that speed changes to low immediately. When digital "0" is input to CF, phase correcting speed of PLL remains low regardless of the phase difference. Usually, CF is connected to digital "1".</p>																	
CT	<p>PLL's lock-in characteristics can be selected with CT. When digital "1" is put on CT, PLL requires max. 50 bit alternative data pattern. On the other hand, when digital "0" is input to CT, PLL can be locked in below 18-bit data.</p> <table border="1" data-bbox="355 1174 911 1288"> <thead> <tr> <th>CF</th> <th>CT</th> <th>MIN</th> <th>TYP</th> <th>MAX</th> <th>UNIT</th> </tr> </thead> <tbody> <tr> <td>1</td> <td>0</td> <td>—</td> <td>—</td> <td>18</td> <td rowspan="2">bit</td> </tr> <tr> <td>1</td> <td>1</td> <td>—</td> <td>—</td> <td>50</td> </tr> </tbody> </table>	CF	CT	MIN	TYP	MAX	UNIT	1	0	—	—	18	bit	1	1	—	—	50
CF	CT	MIN	TYP	MAX	UNIT													
1	0	—	—	18	bit													
1	1	—	—	50														
\overline{FT}	<p>Control signal for the internal connection of AO. Refer to column AO. When digital "0" is input to this pin, transmit LPF enters in power down mode, but the output buffer operational amplifier remains active. In this case, AO is at SG level.</p>																	
V_{DD}	<p>Power supply. MSM6882-3: 3.6 V MSM6882-5: 5 V This device is sensitive to supply noise as switched capacitor techniques are utilized. A bypass capacitor of more than 2.2 μF between V_{DD} and GND is indispensable to ensure the performance.</p>																	

ABSOLUTE MAXIMUM RATINGS

Parameter	Symbol	Condition	Rating	Unit
Power Supply Voltage	V _{DD}	T _a = 25°C With respect to GND	-0.3 to 7.0	V
Input Voltage *1	V _I		-0.3 to V _{DD} + 0.3	
Operating Temperature	T _{op}	—	-25 to 70	°C
Storage Temperature	T _{STG}	—	-55 to 150	

*1 MCS, ME, SD, SIN, PRE, BR, TI, AI, CDT, CF, CT, FT

RECOMMENDED OPERATING CONDITIONS

Parameter	Symbol	Condition	Min.	Typ.	Max.	Unit	
Power Supply Voltage	V _{DD}	With respect to GND	*1 3.0	3.6	4.0	V	
			*2 4.5	5	5.5		
	GND	—	—	0	—		
Operating Temperature	T _{op}	—	-25	25	70	°C	
Crystal Resonant Frequency	f _{X TAL}	MCS = "1"	7.3721	7.3728	7.3735	MHz	
		MCS = "0"	3.6860	3.6864	3.6868		
Data Speed	T _S	MCS = "1", BR = "1"	—	2400	—	bit/sec	
		BR = "0"	—	1200	—		
C1	—	—	—	2.2	—	μF	
C2	—	—	—	0.1	—		
C3	—	—	—	0.047	—		
C4	—	R _{LX} ≥ 40 kΩ	—	0.047	—		
C5	—	—	—	0.047	—		
C6	—	—	—	0.1	—		
Crystal	Oscillation Frequency	—	—	7.3728	—	MHz	
	Frequency Deviation	—	25 ±5°C	-100	—	+100	ppm
	Temperature Characteristics	—	At -30°C to +70°C	-100	—	+100	
	Equivalent Series Resistance	—	—	—	—	50	
	Load Capacitance	—	—	—	16	—	pF
Crystal	Oscillation Frequency	—	—	3.6864	—	MHz	
	Frequency Deviation	—	25 ±5°C	-100	—	+100	ppm
	Temperature Characteristics	—	At -30°C to +70°C	-100	—	+100	
	Equivalent Series Resistance	—	—	—	—	100	
	Load Capacitance	—	—	—	16	—	pF

*1 MSM6882-3

*2 MSM6882-5

ELECTRICAL CHARACTERISTICS

DC Characteristics

(MSM6882-3: $V_{DD} = 3\text{ V to }4\text{ V}$, $T_a = -25^\circ\text{C to }70^\circ\text{C}$)
 (MSM6882-5: $V_{DD} = 5\text{ V} \pm 0.5\text{ V}$, $T_a = -25^\circ\text{C to }70^\circ\text{C}$)

Parameter	Symbol	Condition	Min.	Typ.	Max.	Unit
Power Supply Current *1	I_{DD}	Normal Operating Mode $\overline{FT} = "1"$	—	4	8	mA
			—	5.5	11	
	I_{DDS}	Power Down Mode $\overline{FT} = "0"$	—	3.5	7	
			—	5.0	10	
Input Leakage Current *2	I_{IL}	$V_{IN} = 0\text{ V}$	-10	—	10	μA
	I_{IH}	$V_{IN} = V_{DD}$	-10	—	10	
Input Voltage *2	V_{IL}	*1	0	—	0.6	V
			0.8			
	V_{IH}	*1	1.8	—	V_{DD}	
			2.2			
Output Voltage *1 *3	V_{OL1}	$I_{OL} = 10\ \mu\text{A}/1.6\ \text{mA}$	0	—	0.3	
					0.4	
	V_{OH1}	$I_{OH} = 10\ \mu\text{A}/400\ \mu\text{A}$	$0.8V_{DD}$	—	V_{DD}	

*1 Upper is specified for the MSM6882-3, lower for the MSM6882-5

*2 MCS, ME, SD, SIN, PRE, BR, CF, CT, \overline{FT}

*3 ST, RD, RT

Digital Interface Characteristics

Parameter	Symbol	Condition	Min.	Typ.	Max.	Unit
Input Data Set-up Time	t_S	See Fig.1	300	—	—	ns
Input Data Hold Time	t_H		300	—	—	ns
Output Data Delay Time	t_D	See Fig.2	-300	—	300	ns

Analog Interface Characteristics

Transmit signal output (AO)

(MSM6882-3: $V_{DD} = 3\text{ V to }4\text{ V}$, $T_a = -25^\circ\text{C to }70^\circ\text{C}$)
 (MSM6882-5: $V_{DD} = 5\text{ V} \pm 0.5\text{ V}$, $T_a = -25^\circ\text{C to }70^\circ\text{C}$)

Parameter	Symbol	Condition			Min.	Typ.	Max.	Unit	
Carrier Frequency	1200 bps	f_{M1}	$\overline{FT} = "1"$	BR = "0"	SD = "1"	1199	1200	1201	Hz
		f_{S1}			SD = "0"	1799	1800	1801	
	2400 bps	f_{M2}	ME = "1"	BR = "1"	SD = "1"	1199	1200	1201	
		f_{S2}			SD = "0"	2399	2400	2401	
Carrier Level	*1 V_{OX}	$R_L \geq 40\text{ k}\Omega$			$\overline{FT} = "1"$	-7	-3	-1	dBm
					ME = "1"	-3	0	2	
Output Amplitude	*1 V_{OPP}	$C_L \leq 40\text{ pF}$			$\overline{FT} = "1"$	1.4	2.0	—	V_{p-p}
					ME = "0"	2.2	3.0	—	
Output Resistance	R_{OX}	—			—	50	—	Ω	
Output Load Resistance	R_{LX}	—			40	—	—	k Ω	
Output Load Capacitance	C_{LX}	—			—	—	40	pF	
Output DC Voltage	V_{OSX}	—			$0.48V_{DD}$	$0.50V_{DD}$	$0.52V_{DD}$	V	

Voice signal input (TI)

Parameter	Symbol	Condition		Min.	Typ.	Max.	Unit
Voltage Gain	GT	V_{AO}/V_{TI}	$\overline{FT} = "1"$ ME = "0"	-2	0	+2	dB
Input Signal Level	*1 V_{TI}	—		—	—	-4	
						0	*2
Input Resistance	R_{TI}	$f_{TI} \leq 4\text{ kHz}$		40	100	300	k Ω

Built-in signal ground (SG)

Parameter	Symbol	Condition	Min.	Typ.	Max.	Unit
DC Voltage	V_{SG}	Without DC Load	$0.48V_{DD}$	$0.50V_{DD}$	$0.52V_{DD}$	V

Receive signal input (AI)

Parameter	Symbol	Condition		Min.	Typ.	Max.	Unit	
Input Resistance	R_{AI}	$f_{AI} \leq 4\text{ kHz}$		40	100	300	k Ω	
Receive Signal Level	V_{IR1}	—	BR = "0"	-30	—	0	dBm	
	V_{IR2}		BR = "1"	-24	—	0		
Bit Error Rate	1200 bps	BER	S/N at AI SIN = "1"	S/N	7 dB	—	2×10^{-3}	—
					11 dB	—	2×10^{-5}	—
	2400 bps				10 dB	—	2×10^{-3}	—
					14 dB	—	2×10^{-5}	—

*1 Upper is specified for the MSM6882-3, lower for the MSM6882-5

*2 0 dBm = 0.775 Vrms

Re-generated receive data timing clock output (RT)

Parameter	Symbol	Condition			Min.	Typ.	Max.	Unit
Data Bit Number for PLL ' Lock-in	N _{PLL1}	CF = "1"	CT = "0"	*3	—	—	18	bit
	N _{PLL2}		CT = "1"		—	—	50	

*3 Data bit number to lock-in within 22.5 degree

TIMING DIAGRAM

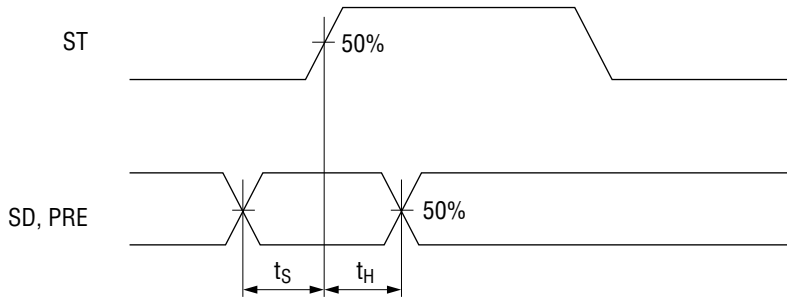

Figure 1 Input Data Timing

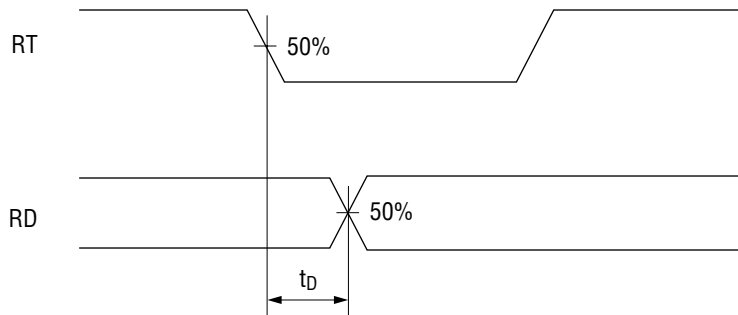
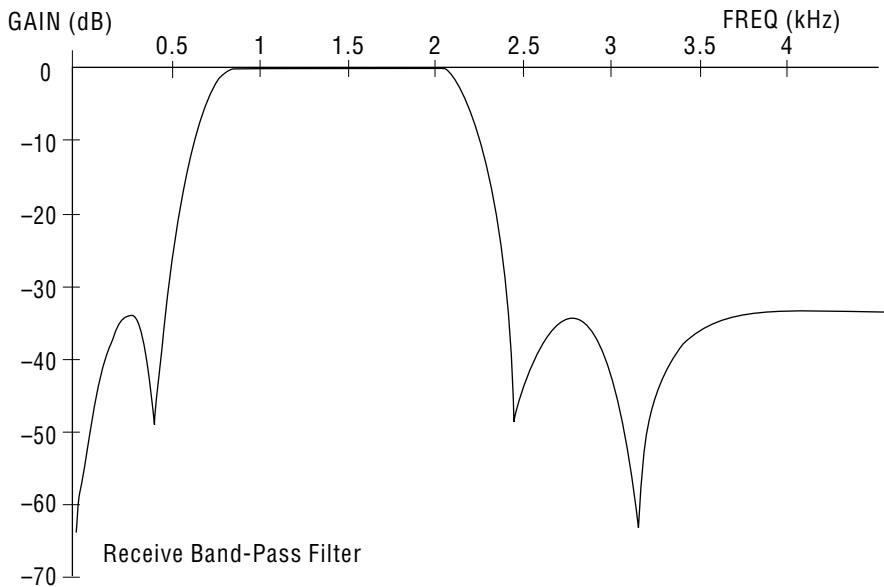
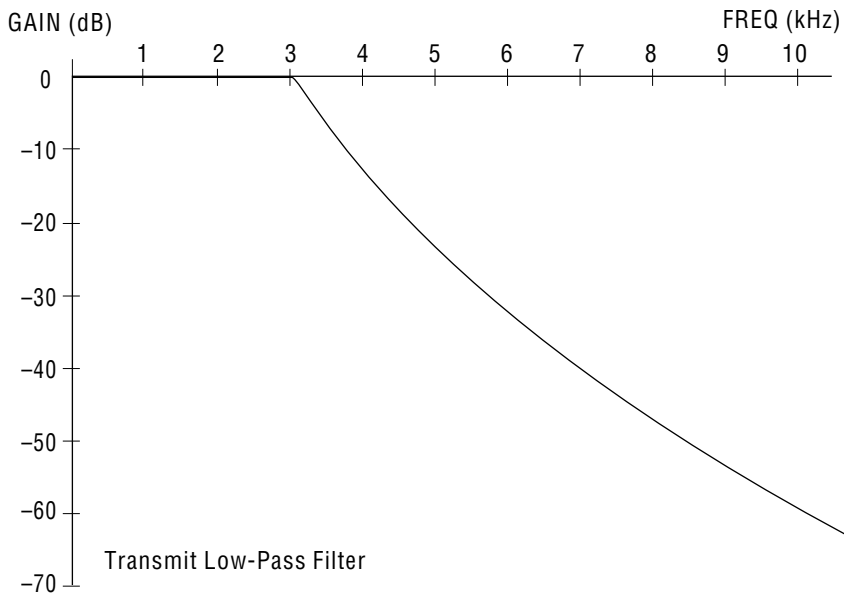

Figure 2 Output Data Timing

BUILT-IN FILTER FREQUENCY CHARACTERISTICS



Note: When BR = "1", frequency converter circuit (MIXER) is prepared before the receive BPF. Therefore, 1200 Hz input signal is converted to 3600 Hz at BPF output for example.

APPLICATION CIRCUIT

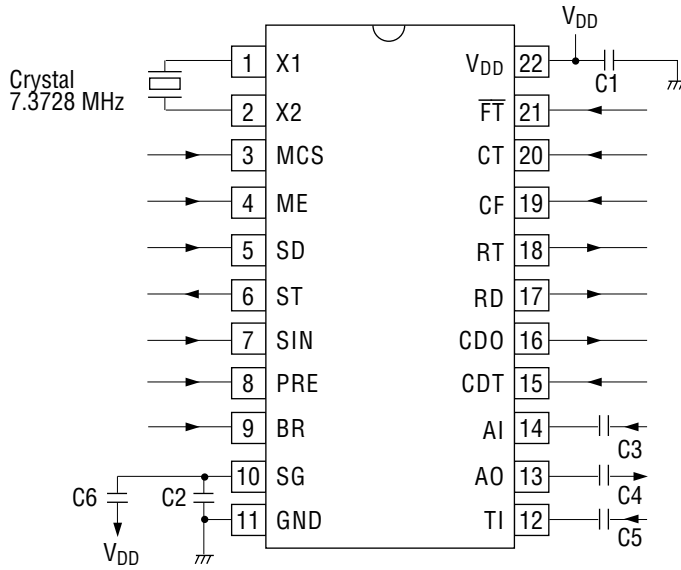

PACKAGE DIMENSIONS

(Unit : mm)

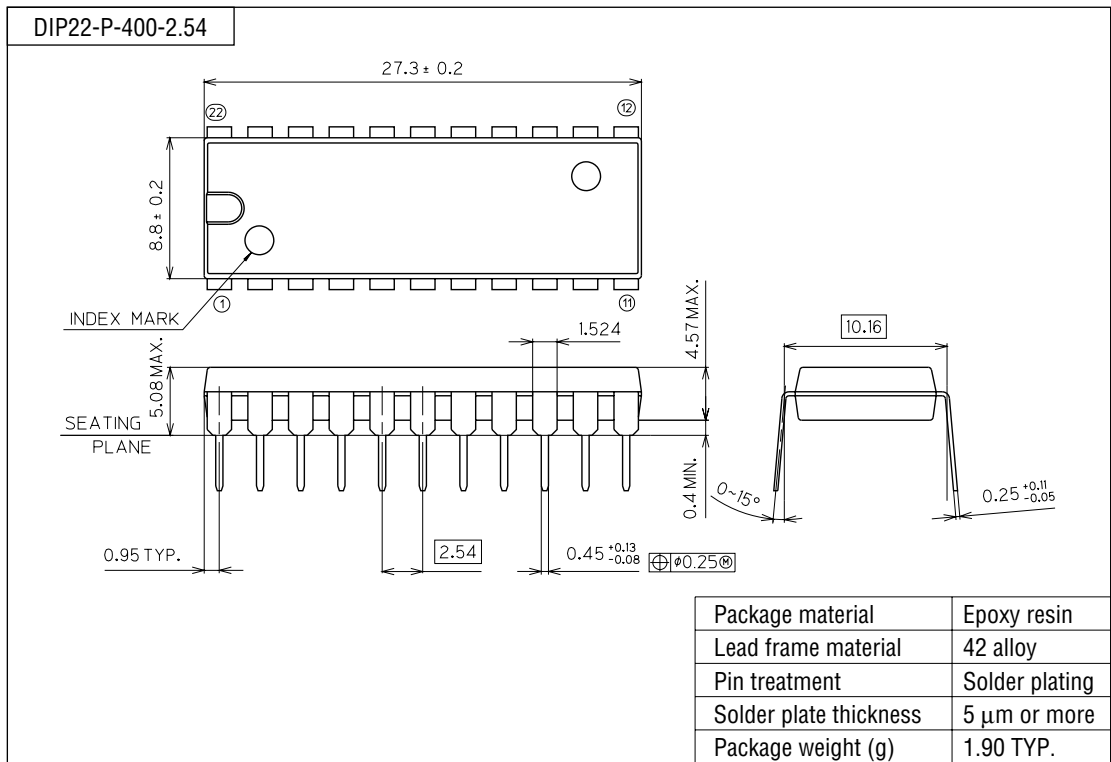

(Unit : mm)

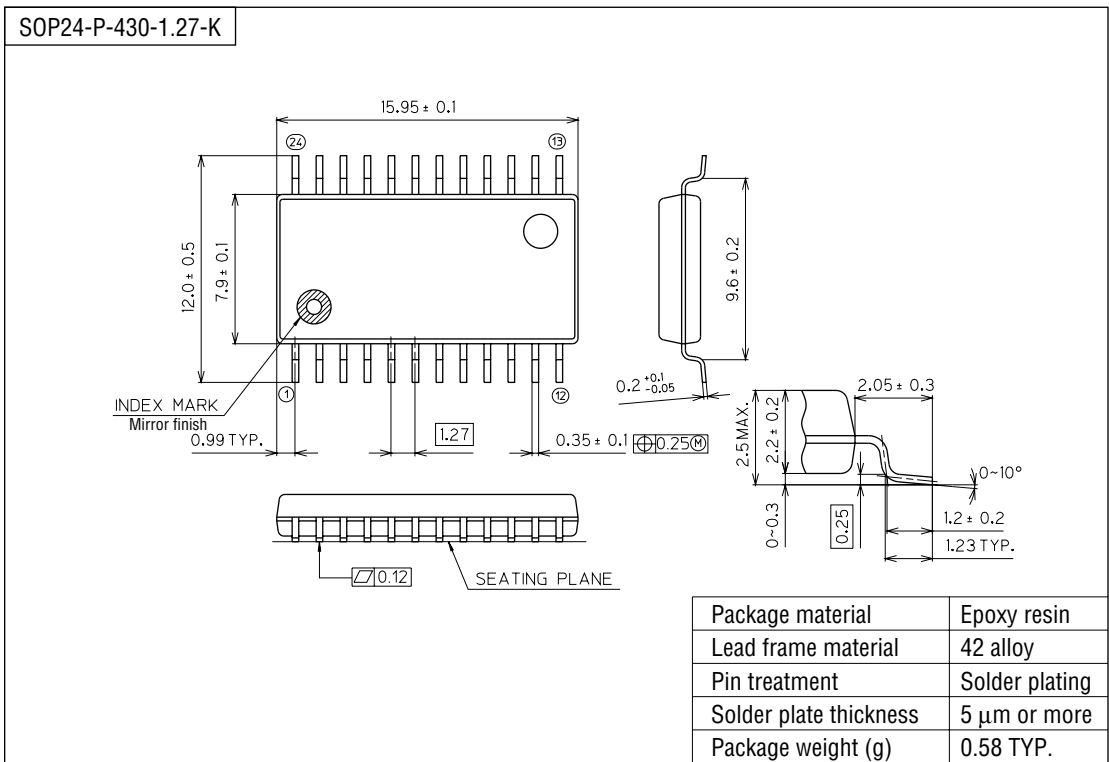

Notes for Mounting the Surface Mount Type Package

The SOP, QFP, TSOP, SOJ, QFJ (PLCC), SHP and BGA are surface mount type packages, which are very susceptible to heat in reflow mounting and humidity absorbed in storage. Therefore, before you perform reflow mounting, contact Oki's responsible sales person for the product name, package name, pin number, package code and desired mounting conditions (reflow method, temperature and times).