



MOTOROLA

Octal Transceiver/Register With 3-State Outputs (Non-Inverting)

The MC74AC/ACT652 consists of registered bus transceiver circuits, with outputs, D-type flip-flops and control circuitry providing multiplexed transmission of data directly from the input bus or from the internal storage registers. Data on the A or B bus will be loaded into the respective registers on the LOW-to-HIGH transition of the appropriate clock pin (CAB or CBA). The four fundamental data handling functions available are illustrated in Figures 1 to 4.

- Independent Registers for A and B Buses
- Multiplexed Real-Time and Stored Data Transfers
- Choice of True and Inverting Data Paths
- 3-State Outputs
- 300 mil Slim Dual-in-Line Package
- Outputs Source/Sink 24 mA
- 'ACT652 Has TTL Compatible Inputs

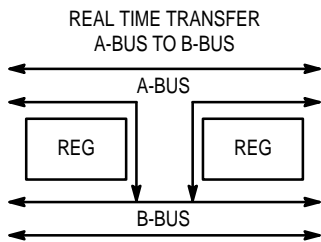

Figure 1

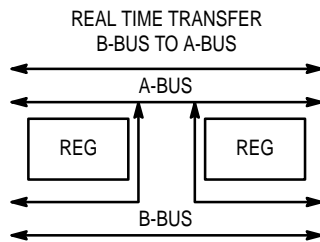

Figure 2

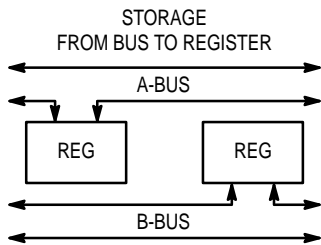

Figure 3

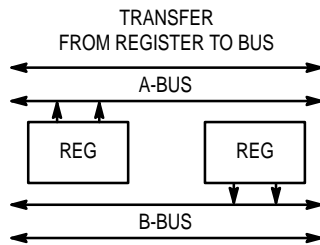
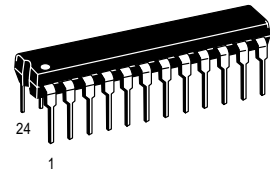

Figure 4

**MC74AC652
MC74ACT652**

**OCTAL TRANSCEIVER/
REGISTER WITH 3-STATE
OUTPUTS (NON-INVERTING)**



**N SUFFIX
CASE 724-03
PLASTIC PACKAGE**

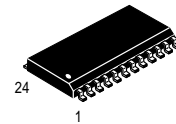

**DW SUFFIX
CASE 751E-04
SOIC PACKAGE**

PIN NAMES

- A₀ – A₇ Data Register A Inputs
- Data Register A Outputs
- B₀ – B₇ Data Register B Inputs
- Data Register B Outputs
- CAB, CBA Clock Pulse Inputs
- SAB, SBA Transmit/Receive Inputs
- GAB, GBA Output Enable Inputs

MAXIMUM RATINGS*

Symbol	Parameter	Value	Unit
V _{CC}	DC Supply Voltage (Referenced to GND)	-0.5 to +7.0	V
V _{in}	DC Input Voltage (Referenced to GND)	-0.5 to V _{CC} + 0.5	V
V _{out}	DC Output Voltage (Referenced to GND)	-0.5 to V _{CC} + 0.5	V
I _{in}	DC Input Current, per Pin	± 20	mA
I _{out}	DC Output Sink/Source Current, per Pin	± 50	mA
I _{CC}	DC V _{CC} or GND Current per Output Pin	± 50	mA
T _{stg}	Storage Temperature	-65 to +150	°C

* Maximum Ratings are those values beyond which damage to the device may occur. Functional operation should be restricted to the Recommended Operating Conditions.

MC74AC652 MC74ACT652

Pinout: 24-Lead Plastic Package (Top View)

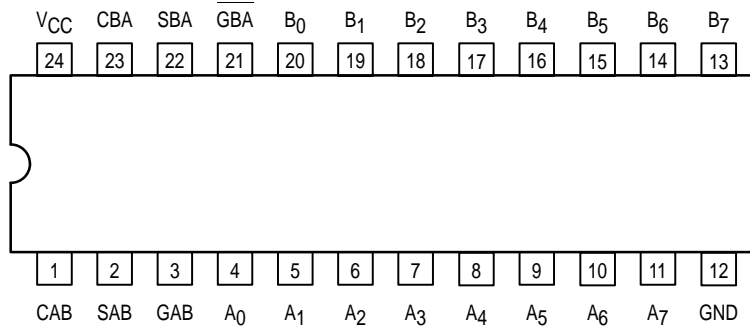

LOGIC SYMBOL

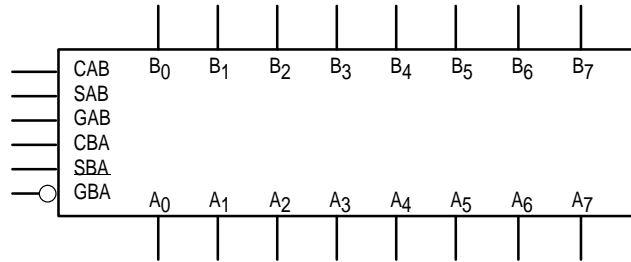

LOGIC DIAGRAM

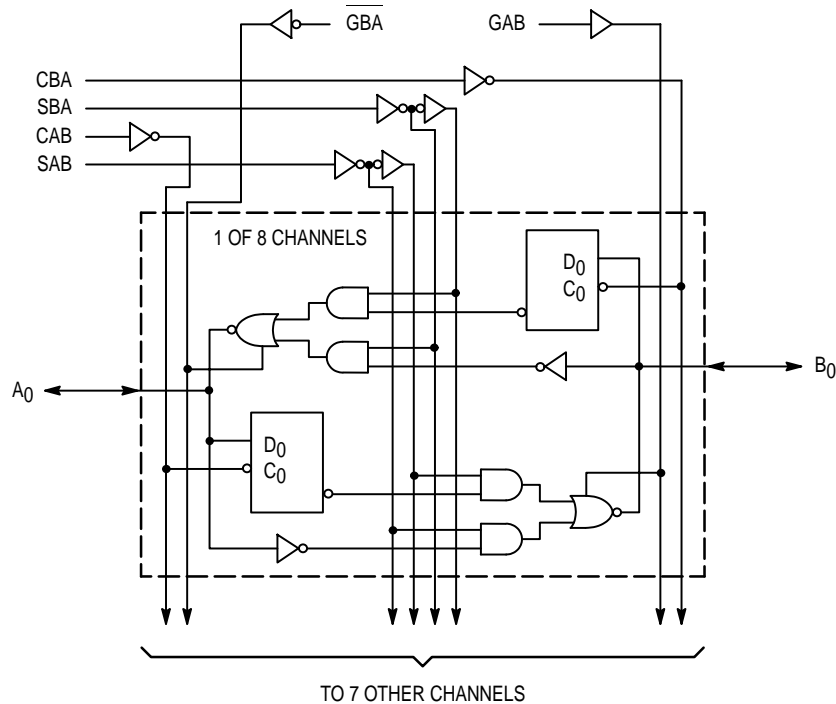

Please note that this diagram is provided only for the understanding of logic operations and should not be used to estimate propagation delays.

MC74AC652 MC74ACT652

FUNCTION TABLE

Inputs						Data I/O*		Operation or Function
GAB	GBA	CAB	CBA	SAB	SBA	A ₀ – A ₇	B ₀ – B ₇	
L L	H H	H or L ↑	H or L ↑	X X	X X	Input	Input	Isolation Store A and B Data
X H	H H	↑ ↑	H or L ↑	X X**	X X	Input Input	Unspecified* Output	Store A, Hold B Store A in Both Registers
L L	X L	H or L ↑	↑ ↑	X X	X X**	Unspecified* Output	Input Input	Hold A, Store B Store B in Both Registers
L L	L L	X X	X H or L	X X	L H	Output	Input	Real-Time B Data to A Bus Stored B Data to A Bus
H H	H H	X H or L	X X	L H	X X	Input	Output	Real-Time A Data to B Bus Stored A Data to B Bus
H	L	H or L	H or L	H	H	Output	Output	Stored A Data to B Bus and Stored B Data to A Bus

* The data output functions may be enabled or disabled by various signals at the GBA and GAB inputs. Data input functions are always enabled; i.e., data at the bus pins will be stored on every LOW-to-HIGH transition of the appropriate clock inputs.

** Select control = L: clocks can occur simultaneously.

H = HIGH Voltage Level; L = LOW Voltage Level; X = Immaterial; ↑ = LOW-to-HIGH Transition

RECOMMENDED OPERATING CONDITIONS

Symbol	Parameter	Min	Typ	Min	Unit	
V _{CC}	Supply Voltage	'AC	2.0	5.0	6.0	V
		'ACT	4.5	5.0	5.5	
V _{in} , V _{out}	DC Input Voltage, Output Voltage (Ref. to GND)	0		V _{CC}	V	
t _r , t _f	Input Rise and Fall Time (Note 1) 'AC Devices except Schmitt Inputs	V _{CC} @ 3.0 V		150	ns/V	
		V _{CC} @ 4.5 V		40		
		V _{CC} @ 5.5 V		25		
t _r , t _f	Input Rise and Fall Time (Note 2) 'ACT Devices except Schmitt Inputs	V _{CC} @ 4.5 V		10	ns/V	
		V _{CC} @ 5.5 V		8.0		
T _J	Junction Temperature (PDIP)			140	°C	
T _A	Operating Ambient Temperature Range	-40	25	85	°C	
I _{OH}	Output Current — HIGH			-24	mA	
I _{OL}	Output Current — LOW			24	mA	

1. V_{in} from 30% to 70% V_{CC}; see individual Data Sheets for devices that differ from the typical input rise and fall times.

2. V_{in} from 0.8 V to 2.0 V; see individual Data Sheets for devices that differ from the typical input rise and fall times.

MC74AC652 MC74ACT652

DC CHARACTERISTICS

Symbol	Parameter	V _{CC} (V)	74AC		74AC		Unit	Conditions
			T _A = +25°C		T _A = -40°C to +85°C			
			Typ	Guaranteed Limits				
V _{IH}	Minimum High Level Input Voltage	3.0	1.5	2.1	2.1	V	V _{OUT} = 0.1 V or V _{CC} - 0.1 V	
		4.5	2.25	3.15	3.15			
		5.5	2.75	3.85	3.85			
V _{IL}	Maximum Low Level Input Voltage	3.0	1.5	0.9	0.9	V	V _{OUT} = 0.1 V or V _{CC} - 0.1 V	
		4.5	2.25	1.35	1.35			
		5.5	2.75	1.65	1.65			
V _{OH}	Minimum High Level Output Voltage	3.0	2.99	2.9	2.9	V	I _{OUT} = - 50 μA	
		4.5	4.49	4.4	4.4			
		5.5	5.49	5.4	5.4			
		3.0		2.56	2.46	V	*V _{IN} = V _{IL} or V _{IH} - 12 mA I _{OH} - 24 mA - 24 mA	
		4.5		3.86	3.76			
		5.5		4.86	4.76			
V _{OL}	Minimum Low Level Output Voltage	3.0	0.002	0.1	0.1	V	I _{OUT} = 50 μA	
		4.5	0.001	0.1	0.1			
		5.5	0.001	0.1	0.1			
		3.0		0.36	0.44	V	*V _{IN} = V _{IL} or V _{IH} 12 mA I _{OL} 24 mA 24 mA	
		4.5		0.36	0.44			
		5.5		0.36	0.44			
I _{IN}	Maximum Input Leakage Current	5.5		±0.1	±1.0	μA	V _I = V _{CC} , GND	
I _{OZT}	Maximum 3-State Current	5.5		±0.6	±6.0	μA	V _I (OE) = V _{IL} , V _{IH} V _I = V _{CC} , GND V _O = V _{CC} , GND	
I _{OLD}	†Minimum Dynamic Output Current	5.5			75	mA	V _{OLD} = 1.65 V Max	
I _{OHD}		5.5			-75	mA	V _{OHD} = 3.85 V Min	
I _{CC}	Maximum Quiescent Supply Current	5.5		8.0	80	μA	V _{IN} = V _{CC} or GND	

* All outputs loaded; thresholds on input associated with output under test.

† Maximum test duration 2.0 ms, one input loaded at a time.

Note: I_{IN} and I_{CC} @ 3.0 V are guaranteed to be less than or equal to the respective limit @ 5.5 V.

MC74AC652 MC74ACT652

AC CHARACTERISTICS

Symbol	Parameter	V _{CC} * (V)	74AC		74AC		Unit
			T _A = +25°C C _L = 50 pF		T _A = -40°C to +85°C C _L = 50 pF		
			Min	Max	Min	Max	
t _{PLH}	Propagation Delay CPBA or CPAB to A _n or B _n	3.0	4.0	17.0	3.0	19.0	ns
		5.0	2.5	12.0	2.0	14.0	
t _{PHL}	Propagation Delay CPBA or CPAB to A _n or B _n	3.0	3.0	14.5	2.5	16.5	ns
		5.0	2.0	10.5	1.5	12.0	
t _{PLH}	Propagation Delay A or B to B _n or A _n	3.0	3.0	14.0	2.5	16.0	ns
		5.0	2.0	9.5	1.5	11.0	
t _{PHL}	Propagation Delay A or B to B _n or A _n	3.0	2.5	13.0	2.0	15.0	ns
		5.0	1.5	9.0	1.0	10.5	
t _{PLH}	Propagation Delay SBA or SAB to A _n or B _n	3.0	3.0	14.0	2.5	16.0	ns
		5.0	2.5	10.0	2.0	11.5	
t _{PHL}	Propagation Delay SBA or SAB to A _n or B _n	3.0	2.5	13.5	2.0	15.5	ns
		5.0	2.0	10.0	1.5	11.5	
t _{PZH}	Output Enable Time OEBA to A _n	3.0	2.5	12.0	2.0	13.5	ns
		5.0	1.5	9.0	1.0	10.0	
t _{PZL}	Output Enable Time OEBA to A _n	3.0	2.5	12.0	2.0	14.0	ns
		5.0	1.5	9.0	1.0	10.5	
t _{PHZ}	Output Disable Time OEBA to A _n	3.0	3.0	13.0	2.5	14.0	ns
		5.0	2.0	11.0	1.5	12.0	
t _{PLZ}	Output Disable Time OEBA to A _n	3.0	2.5	12.5	2.0	14.0	ns
		5.0	2.0	10.5	1.5	12.0	

* Voltage Range 3.3 V is 3.3 V ±0.3 V.
Voltage Range 5.0 V is 5.0 V ±0.5 V.

MC74AC652 MC74ACT652

DC CHARACTERISTICS

Symbol	Parameter	V _{CC} (V)	74ACT		74ACT		Unit	Conditions
			T _A = +25°C		T _A = -40°C to +85°C			
			Typ	Guaranteed Limits				
V _{IH}	Minimum High Level Input Voltage	4.5	1.5	2.0	2.0	V	V _{OUT} = 0.1 V or V _{CC} - 0.1 V	
		5.5	1.5	2.0	2.0			
V _{IL}	Maximum Low Level Input Voltage	4.5	1.5	0.8	0.8	V	V _{OUT} = 0.1 V or V _{CC} - 0.1 V	
		5.5	1.5	0.8	0.8			
V _{OH}	Minimum High Level Output Voltage	4.5	4.49	4.4	4.4	V	I _{OUT} = - 50 μA	
		5.5	5.49	5.4	5.4			
		4.5		3.86	3.76	V	*V _{IN} = V _{IL} or V _{IH} - 24 mA I _{OH} - 24 mA	
5.5		4.86	4.76					
V _{OL}	Minimum Low Level Output Voltage	4.5	0.001	0.1	0.1	V	I _{OUT} = - 50 μA	
		5.5	0.001	0.1	0.1			
		4.5		0.36	0.44	V	*V _{IN} = V _{IL} or V _{IH} - 24 mA I _{OH} - 24 mA	
5.5		0.36	0.44					
I _{IN}	Maximum Input Leakage Current	5.5		±0.1	±1.0	μA	V _I = V _{CC} , GND	
ΔI _{CCT}	Additional Max. I _{CC} /Input	5.5	0.6		1.5	mA	V _I = V _{CC} - 2.1 V	
I _{OZT}	Maximum 3-State Current	5.5		±0.6	±6.0	μA	V _I (OE) = V _{IL} , V _{IH} V _I = V _{CC} , GND V _O = V _{CC} , GND	
I _{OLD}	†Minimum Dynamic Output Current	5.5			75	mA	V _{OLD} = 1.65 V Max	
I _{OHD}		5.5			-75	mA	V _{OHD} = 3.85 V Min	
I _{CC}	Maximum Quiescent Supply Current	5.5		8.0	80	μA	V _{IN} = V _{CC} or GND	

* All outputs loaded; thresholds on input associated with output under test.

† Maximum test duration 2.0 ms, one input loaded at a time.

MC74AC652 MC74ACT652

AC CHARACTERISTICS

Symbol	Parameter	V _{CC} * (V)	74ACT		74ACT		Unit
			T _A = +25°C C _L = 50 pF		T _A = -40°C to +85°C C _L = 50 pF		
			Min	Max	Min	Max	
t _{PLH}	Propagation Delay CPBA or CPAB to A _n or B _n	5.0	4.0	14.5	3.5	16.5	ns
t _{PHL}	Propagation Delay CPBA or CPAB to A _n or B _n	5.0	3.5	14.5	3.0	16.5	ns
t _{PLH}	Propagation Delay A or B to B _n or A _n	5.0	2.5	11.5	2.0	13.0	ns
t _{PHL}	Propagation Delay A or B to B _n or A _n	5.0	2.5	11.5	2.0	13.0	ns
t _{PLH}	Propagation Delay SBA or SAB to A _n or B _n	5.0	2.5	12.0	2.0	13.5	ns
t _{PHL}	Propagation Delay SBA or SAB to A _n or B _n	5.0	3.0	12.0	2.5	13.5	ns
t _{PZH}	Output Enable Time OEBA to A _n	5.0	2.0	11.5	1.5	13.0	ns
t _{PZL}	Output Enable Time OEBA to A _n	5.0	2.5	11.5	2.0	13.0	ns
t _{PHZ}	Output Disable Time OEBA to A _n	5.0	3.0	13.0	2.5	14.0	ns
t _{PLZ}	Output Disable Time OEBA to A _n	5.0	2.5	12.5	2.0	14.0	ns
t _{PZH}	Output Enable time OEAB to B _n	5.0	2.5	12.0	2.0	13.5	ns
t _{PZL}	Output Enable Time OEAB to B _n	5.0	2.5	12.0	2.0	13.5	ns
t _{PHZ}	Output Enable Time OEAB to B _n	5.0	3.5	13.5	3.0	14.5	ns
t _{PLZ}	Output Enable Time OEAB to B _n	5.0	3.0	13.5	2.5	15.0	ns
t _s	Setup Time, HIGH or LOW A _n or B _n to CPBA or CPAB	5.0	7.0		8.0		ns
t _h	Hold Time, HIGH or LOW A _n or B _n to CPBA or CPAB	5.0	2.5		2.5		ns
t _w	CPAB, CPBA Pulse Width HIGH or LOW	5.0	6.0		7.0		ns

* Voltage Range 3.3 V is 3.3 V ±0.3 V.
Voltage Range 5.0 V is 5.0 V ±0.5 V.

CAPACITANCE

Symbol	Parameter	74ACT Typ	Unit	Test Conditions
C _{IN}	Input Capacitance	4.5	pF	V _{CC} = 5.0 V
C _{I/O}	Input/Output Capacitance	15	pF	V _{CC} = 5.0 V
C _{PD}	Power Dissipation Capacitance	60.0	pF	V _{CC} = 5.0 V

MC74AC652 MC74ACT652

OUTLINE DIMENSIONS

N SUFFIX PLASTIC DIP PACKAGE CASE 724-03 ISSUE D

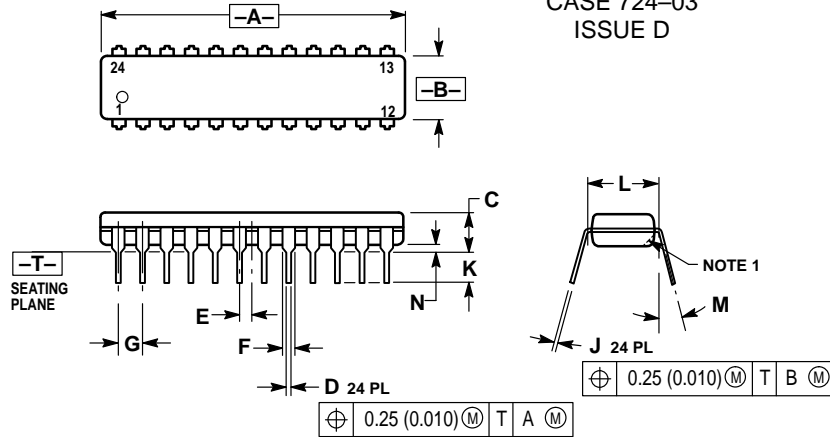

- NOTES:
1. CHAMFERED CONTOUR OPTIONAL.
 2. DIMENSION L TO CENTER OF LEADS WHEN FORMED PARALLEL.
 3. DIMENSIONING AND TOLERANCING PER ANSI Y14.5M, 1982.
 4. CONTROLLING DIMENSION: INCH.

DIM	INCHES		MILLIMETERS	
	MIN	MAX	MIN	MAX
A	1.230	1.285	31.25	32.13
B	0.250	0.270	6.35	6.85
C	0.145	0.175	3.69	4.44
D	0.015	0.020	0.38	0.51
E	0.050 BSC		1.27 BSC	
F	0.040	0.060	1.02	1.52
G	0.100 BSC		2.54 BSC	
J	0.007	0.012	0.18	0.30
K	0.110	0.140	2.80	3.55
L	0.300 BSC		7.62 BSC	
M	0°	15°	0°	15°
N	0.020	0.040	0.51	1.01

DW SUFFIX PLASTIC SOIC PACKAGE CASE 751E-04 ISSUE E

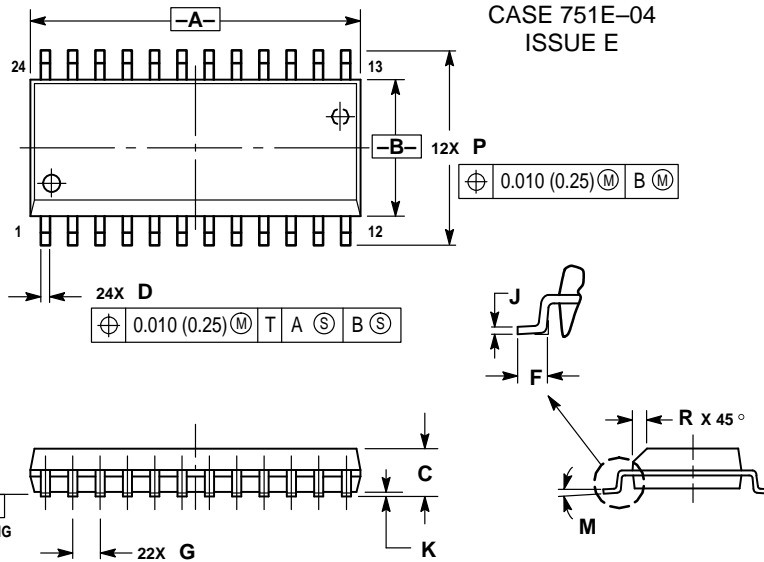

- NOTES:
1. DIMENSIONING AND TOLERANCING PER ANSI Y14.5M, 1982.
 2. CONTROLLING DIMENSION: MILLIMETER.
 3. DIMENSIONS A AND B DO NOT INCLUDE MOLD PROTRUSION.
 4. MAXIMUM MOLD PROTRUSION 0.15 (0.006) PER SIDE.
 5. DIMENSION D DOES NOT INCLUDE DAMBAR PROTRUSION. ALLOWABLE DAMBAR PROTRUSION SHALL BE 0.13 (0.005) TOTAL IN EXCESS OF D DIMENSION AT MAXIMUM MATERIAL CONDITION.

DIM	MILLIMETERS		INCHES	
	MIN	MAX	MIN	MAX
A	15.25	15.54	0.601	0.612
B	7.40	7.60	0.292	0.299
C	2.35	2.65	0.093	0.104
D	0.35	0.49	0.014	0.019
F	0.41	0.90	0.016	0.035
G	1.27 BSC		0.050 BSC	
J	0.23	0.32	0.009	0.013
K	0.13	0.29	0.005	0.011
M	0°	8°	0°	8°
P	10.05	10.55	0.395	0.415
R	0.25	0.75	0.010	0.029

Motorola reserves the right to make changes without further notice to any products herein. Motorola makes no warranty, representation or guarantee regarding the suitability of its products for any particular purpose, nor does Motorola assume any liability arising out of the application or use of any product or circuit, and specifically disclaims any and all liability, including without limitation consequential or incidental damages. "Typical" parameters can and do vary in different applications. All operating parameters, including "Typicals" must be validated for each customer application by customer's technical experts. Motorola does not convey any license under its patent rights nor the rights of others. Motorola products are not designed, intended, or authorized for use as components in systems intended for surgical implant into the body, or other applications intended to support or sustain life, or for any other application in which the failure of the Motorola product could create a situation where personal injury or death may occur. Should Buyer purchase or use Motorola products for any such unintended or unauthorized application, Buyer shall indemnify and hold Motorola and its officers, employees, subsidiaries, affiliates, and distributors harmless against all claims, costs, damages, and expenses, and reasonable attorney fees arising out of, directly or indirectly, any claim of personal injury or death associated with such unintended or unauthorized use, even if such claim alleges that Motorola was negligent regarding the design or manufacture of the part. Motorola and  are registered trademarks of Motorola, Inc. Motorola, Inc. is an Equal Opportunity/Affirmative Action Employer.

How to reach us:

USA/EUROPE: Motorola Literature Distribution;
P.O. Box 20912; Phoenix, Arizona 85036. 1-800-441-2447

JAPAN: Nippon Motorola Ltd.; Tatsumi-SPD-JLDC, Toshikatsu Otsuka,
6F Seibu-Butsuryu-Center, 3-14-2 Tatsumi Koto-Ku, Tokyo 135, Japan. 03-3521-8315

MFAX: RMFAX0@email.sps.mot.com -TOUCHTONE (602) 244-6609
INTERNET: <http://Design-NET.com>

HONG KONG: Motorola Semiconductors H.K. Ltd.; 8B Tai Ping Industrial Park,
51 Ting Kok Road, Tai Po, N.T., Hong Kong. 852-26629298



MC74AC652/D

