

## RADIATION HARDENED POWER MOSFET THRU-HOLE (TO-204AA/AE)

## IRH7250SE 200V, N-CHANNEL RAD Hard™ HEXFET® TECHNOLOGY

### Product Summary

| Part Number | Radiation Level | RDS(on) | ID  |
|-------------|-----------------|---------|-----|
| IRH7250SE   | 100K Rads (Si)  | 0.10Ω   | 26A |



International Rectifier's RADHard™ HEXFET® MOSFET technology provides high performance power MOSFETs for space applications. This technology has over a decade of proven performance and reliability in satellite applications. These devices have been characterized for both Total Dose and Single Event Effects (SEE). The combination of low RDS(on) and low gate charge reduces the power losses in switching applications such as DC to DC converters and motor control. These devices retain all of the well established advantages of MOSFETs such as voltage control, fast switching, ease of paralleling and temperature stability of electrical parameters.

### Features:

- Single Event Effect (SEE) Hardened
- Ultra Low RDS(on)
- Low Total Gate Charge
- Proton Tolerant
- Simple Drive Requirements
- Ease of Paralleling
- Hermetically Sealed
- Light Weight

### Absolute Maximum Ratings

### Pre-Irradiation

|                            | Parameter                       |   | Units |
|----------------------------|---------------------------------|---|-------|
| ID @ VGS = 12V, TC = 25°C  | Continuous Drain Current        | 26  | A     |
| ID @ VGS = 12V, TC = 100°C | Continuous Drain Current        | 16  |       |
| IDM                        | Pulsed Drain Current ①          | 104   |       |
| PD @ TC = 25°C             | Max. Power Dissipation          | 150   | W     |
|                            | Linear Derating Factor          | 1.2   | W/°C  |
| VGS                        | Gate-to-Source Voltage          | ±20   | V     |
| EAS                        | Single Pulse Avalanche Energy ② | 500   | mJ    |
| IAR                        | Avalanche Current ①             | 26  | A     |
| EAR                        | Repetitive Avalanche Energy ①   | 15  | mJ    |
| dv/dt                      | Peak Diode Recovery dv/dt ③     | 5.9   | V/ns  |
| TJ                         | Operating Junction              | -55 to 150                                    | °C    |
| TSTG                       | Storage Temperature Range       |   |       |
|                            | Lead Temperature                | 300 (0.063 in. (1.6mm) from case for 10 sec.) |       |
|                            | Weight                          | 11.5 (Typical)                                | g     |

For footnotes refer to the last page

**Electrical Characteristics @ T<sub>j</sub> = 25°C (Unless Otherwise Specified)**

|                        | Parameter                                    | Min | Typ  | Max   | Units | Test Conditions  |
|------------------------|--|-----|------|-------|-------|--|
| BVDSS                  | Drain-to-Source Breakdown Voltage            | 200 | —    | —     | V     | V <sub>GS</sub> = 0V, I <sub>D</sub> = 1.0mA   |
| ΔBVDSS/ΔT <sub>J</sub> | Temperature Coefficient of Breakdown Voltage | —   | 0.26 | —     | V/°C  | Reference to 25°C, I <sub>D</sub> = 1.0mA  |
| RDS(on)                | Static Drain-to-Source On-State Resistance   | —   | —    | 0.10  | Ω     | V <sub>GS</sub> = 12V, I <sub>D</sub> = 16A ④  |
|                        |  | —   | —    | 0.105 |       | V <sub>GS</sub> = 12V, I <sub>D</sub> = 26A  |
| VGS(th)                | Gate Threshold Voltage                       | 2.5 | —    | 4.5   | V     | V <sub>DS</sub> = V <sub>GS</sub> , I <sub>D</sub> = 1.0mA                                     |
| gfs                    | Forward Transconductance                     | 7.5 | —    | —     | S (τ) | V <sub>DS</sub> > 15V, I <sub>DS</sub> = 16A ④   |
| IDSS                   | Zero Gate Voltage Drain Current              | —   | —    | 25    | μA    | V <sub>DS</sub> = 160V, V <sub>GS</sub> = 0V   |
|                        |  | —   | —    | 250   |       | V <sub>DS</sub> = 160V, V <sub>GS</sub> = 0V, T <sub>J</sub> = 125°C                           |
| IGSS                   | Gate-to-Source Leakage Forward               | —   | —    | 100   | nA    | V <sub>GS</sub> = 20V  |
| IGSS                   | Gate-to-Source Leakage Reverse               | —   | —    | -100  |       | V <sub>GS</sub> = -20V   |
| Qg                     | Total Gate Charge                            | —   | —    | 180   | nC    | V <sub>GS</sub> = 12V, I <sub>D</sub> = 26A<br>V <sub>DS</sub> = 100V                          |
| Qgs                    | Gate-to-Source Charge                        | —   | —    | 35    |       |  |
| Qgd                    | Gate-to-Drain ('Miller') Charge              | —   | —    | 83    |       |  |
| td(on)                 | Turn-On Delay Time                           | —   | —    | 33    | ns    | V <sub>DD</sub> = 100V, I <sub>D</sub> = 26A,<br>V <sub>GS</sub> = 12V, R <sub>G</sub> = 2.35Ω |
| tr                     | Rise Time                                    | —   | —    | 140   |       |  |
| td(off)                | Turn-Off Delay Time                          | —   | —    | 140   |       |  |
| tf                     | Fall Time                                    | —   | —    | 140   |       |  |
| LS + LD                | Total Inductance                             | —   | 10   | —     | nH    | Measured from drain lead (6mm/0.25in. from package) to source lead (6mm/0.25in. from package)  |
| Ciss                   | Input Capacitance                            | —   | 3100 | —     | pF    | V <sub>GS</sub> = 0V, V <sub>DS</sub> = 25V<br>f = 1.0MHz                                      |
| Coss                   | Output Capacitance                           | —   | 990  | —     |       |  |
| Crss                   | Reverse Transfer Capacitance                 | —   | 380  | —     |       |  |

**Source-Drain Diode Ratings and Characteristics**

|     | Parameter                              | Min   | Typ | Max | Units | Test Conditions   |
|-----|--|---|-----|-----|-------|---|
| IS  | Continuous Source Current (Body Diode) | —   | —   | 26  | A     |   |
| ISM | Pulse Source Current (Body Diode) ①    | —   | —   | 104 |       |   |
| VSD | Diode Forward Voltage                  | —   | —   | 1.9 | V     | T <sub>J</sub> = 25°C, I <sub>S</sub> = 26A, V <sub>GS</sub> = 0V ④ |
| trr | Reverse Recovery Time                  | —   | —   | 550 | nS    | T <sub>J</sub> = 25°C, I <sub>F</sub> = 26A, di/dt ≤ 100A/μs        |
| QRR | Reverse Recovery Charge                | —   | —   | 8.8 | μC    | V <sub>DD</sub> ≤ 50V ④   |
| ton | Forward Turn-On Time                   | Intrinsic turn-on time is negligible. Turn-on speed is substantially controlled by LS + LD. |     |     |       |   |

**Thermal Resistance**

|       | Parameter           | Min | Typ  | Max  | Units | Test Conditions      |
|-------|---------------------|-----|------|------|-------|----------------------|
| RthJC | Junction-to-Case    | —   | —    | 0.83 | °C/W  | Typical socket mount |
| RthCS | Case-to-Sink        | —   | 0.12 | —    |       |                      |
| RthJA | Junction-to-Ambient | —   | —    | 30   |       |                      |

**Note:** Corresponding Spice and Saber models are available on the G&S Website.

For footnotes refer to the last page

International Rectifier Radiation Hardened MOSFETs are tested to verify their radiation hardness capability. The hardness assurance program at International Rectifier is comprised of two radiation environments. Every manufacturing lot is tested for total ionizing dose (per notes 5 and 6) using the TO-3 package. Both pre- and post-irradiation performance are tested and specified using the same drive circuitry and test conditions in order to provide a direct comparison.

**Table 1. Electrical Characteristics @ Tj = 25°C, Post Total Dose Irradiation ⑤⑥**

|                     | Parameter                                       | 100K Rads (Si) |      | Units | Test Conditions ⑧  |
|---------------------|---|----------------|------|-------|--|
|                     |   | Min            | Max  |       |  |
| BV <sub>DSS</sub>   | Drain-to-Source Breakdown Voltage               | 200            | —    | V     | V <sub>GS</sub> = 0V, I <sub>D</sub> = 1.0mA               |
| V <sub>GS(th)</sub> | Gate Threshold Voltage                          | 2.0            | 4.5  |       | V <sub>GS</sub> = V <sub>DS</sub> , I <sub>D</sub> = 1.0mA |
| I <sub>GSS</sub>    | Gate-to-Source Leakage Forward                  | —              | 100  | nA    | V <sub>GS</sub> = 20V                                      |
| I <sub>GSS</sub>    | Gate-to-Source Leakage Reverse                  | —              | -100 |       | V <sub>GS</sub> = -20V                                     |
| I <sub>DSS</sub>    | Zero Gate Voltage Drain Current                 | —              | 50   | μA    | V <sub>DS</sub> = 160V, V <sub>GS</sub> = 0V               |
| R <sub>DS(on)</sub> | Static Drain-to-Source ④<br>On-State Resistance | —              | 0.10 | Ω     | V <sub>GS</sub> = 12V, I <sub>D</sub> = 16A                |
| V <sub>SD</sub>     | Diode Forward Voltage ④                         | —              | 1.9  | V     | V <sub>GS</sub> = 0V, I <sub>D</sub> = 26A                 |

International Rectifier radiation hardened MOSFETs have been characterized in heavy ion environment for Single Event Effects (SEE). Single Event Effects characterization is illustrated in Fig. a and Table 2.

**Table 2. Single Event Effect Safe Operating Area**

| Ion | LET<br>MeV/(mg/cm <sup>2</sup> ) | Energy<br>(MeV) | Range<br>(μm) | V <sub>DS</sub> (V)  |                       |                        |                        |                        |
|-----|----------------------------------|-----------------|---------------|----------------------|-----------------------|------------------------|------------------------|------------------------|
|     |                                  |                 |               | @V <sub>GS</sub> =0V | @V <sub>GS</sub> =-5V | @V <sub>GS</sub> =-10V | @V <sub>GS</sub> =-15V | @V <sub>GS</sub> =-20V |
| Cu  | 28                               | 285             | 43            | 200                  | 200                   | 200                    | 200                    | 200                    |
| Br  | 36.8                             | 305             | 39            | 200                  | 200                   | 200                    | 180                    | 140                    |

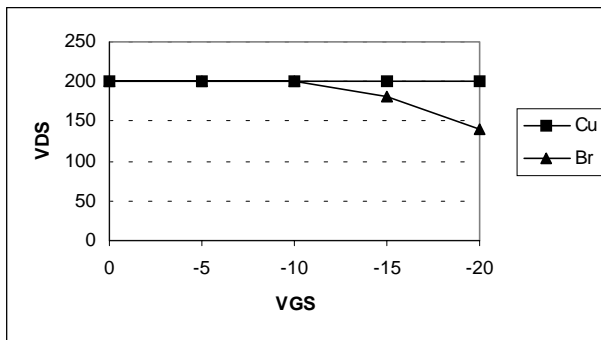

**Fig a. Single Event Effect, Safe Operating Area**

For footnotes refer to the last page

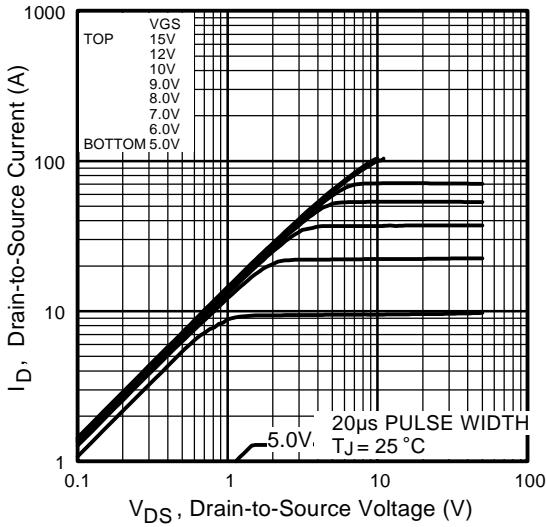

Fig 1. Typical Output Characteristics

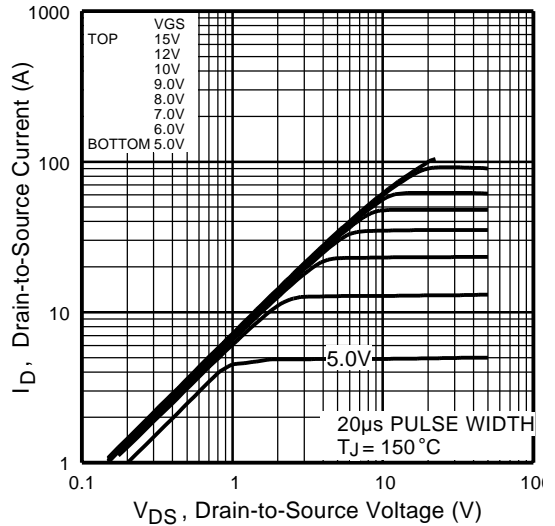

Fig 2. Typical Output Characteristics

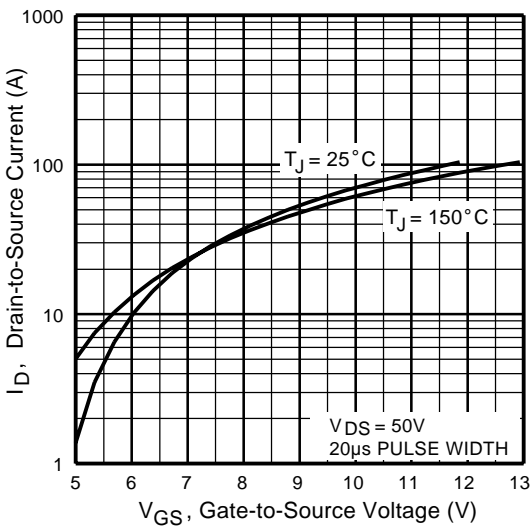

Fig 3. Typical Transfer Characteristics

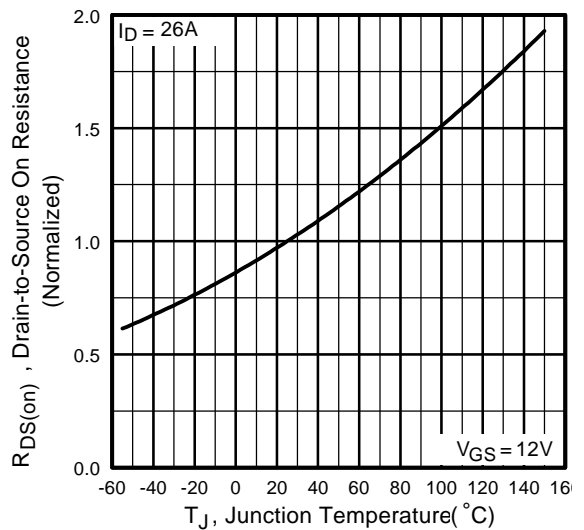
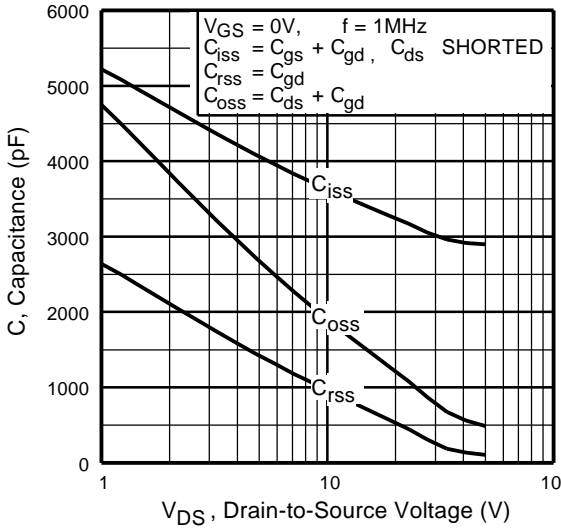
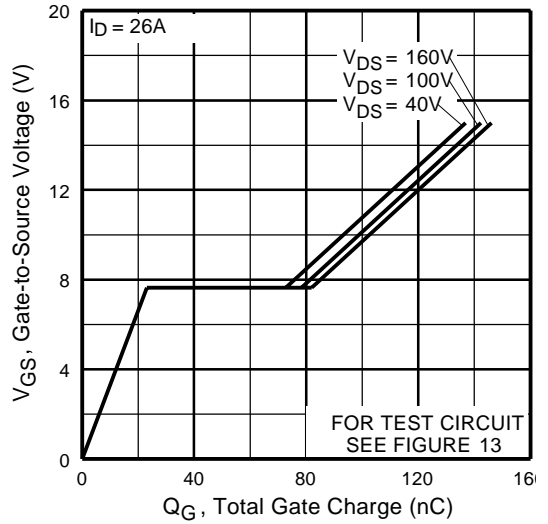

Fig 4. Normalized On-Resistance Vs. Temperature



**Fig 5.** Typical Capacitance Vs. Drain-to-Source Voltage



**Fig 6.** Typical Gate Charge Vs. Gate-to-Source Voltage

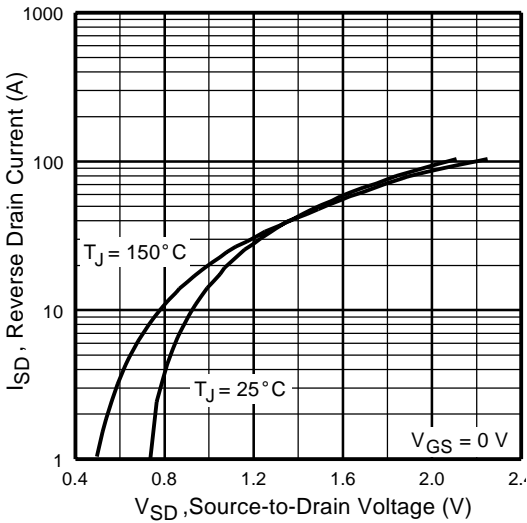

**Fig 7.** Typical Source-Drain Diode Forward Voltage

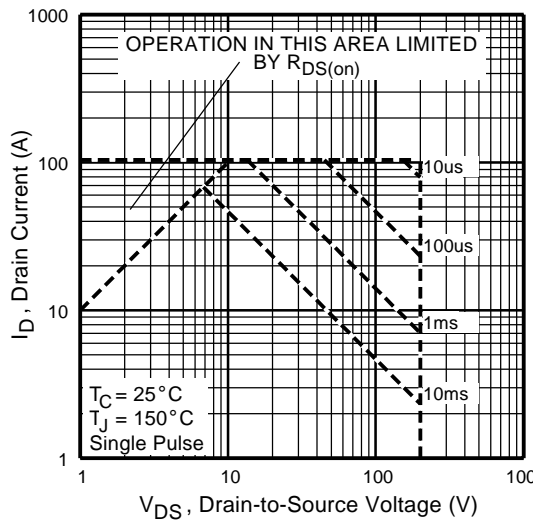

**Fig 8.** Maximum Safe Operating Area

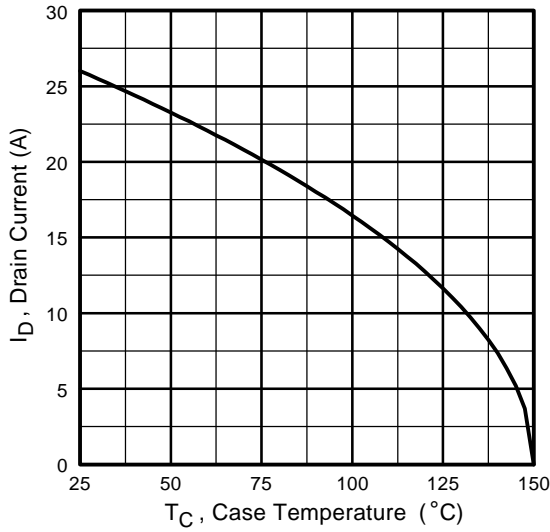

**Fig 9.** Maximum Drain Current Vs. Case Temperature

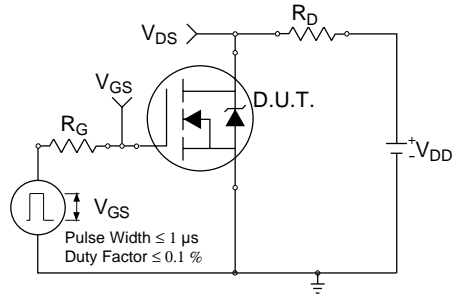

**Fig 10a.** Switching Time Test Circuit

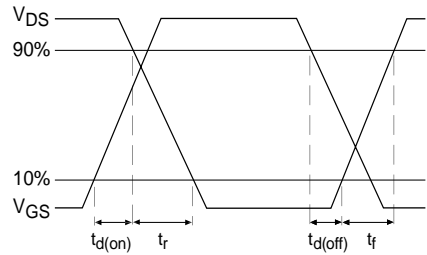

**Fig 10b.** Switching Time Waveforms

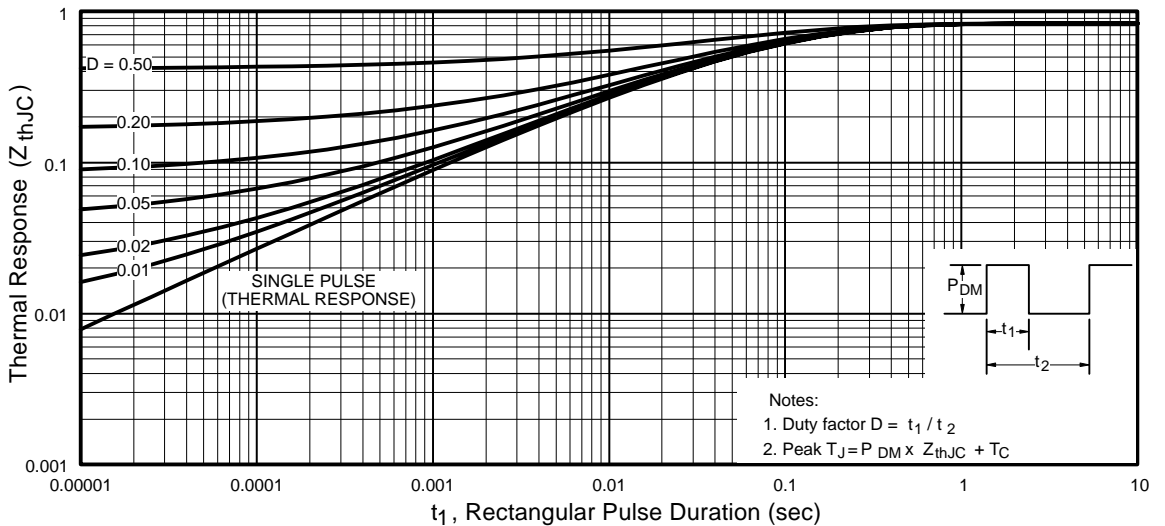

**Fig 11.** Maximum Effective Transient Thermal Impedance, Junction-to-Case

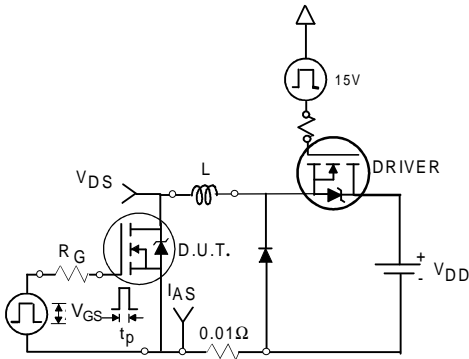

Fig 12a. Unclamped Inductive Test Circuit

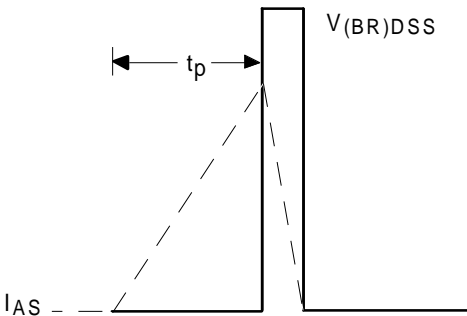

Fig 12b. Unclamped Inductive Waveforms

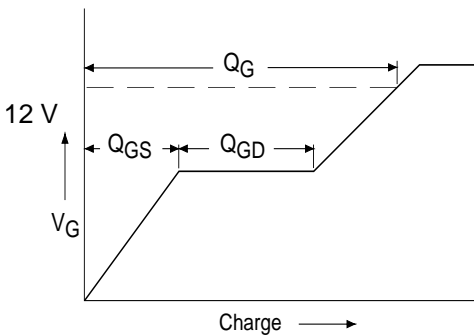

Fig 13a. Basic Gate Charge Waveform

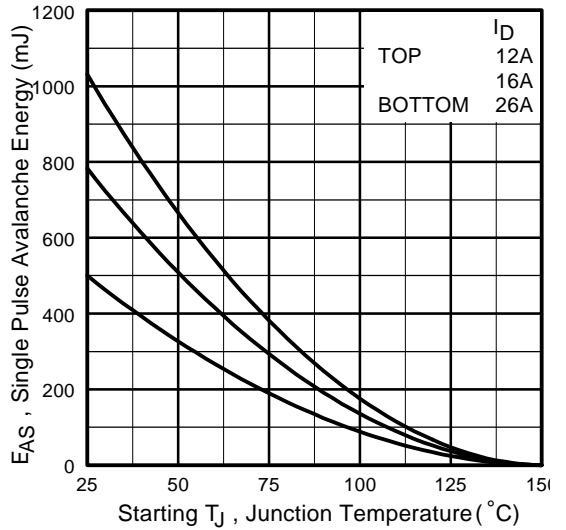

Fig 12c. Maximum Avalanche Energy Vs. Drain Current

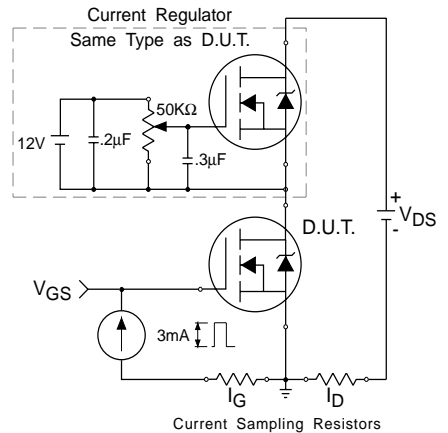
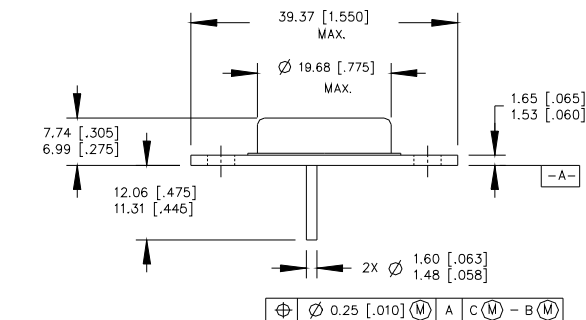

Fig 13b. Gate Charge Test Circuit

**Footnotes:**

- ① Repetitive Rating; Pulse width limited by maximum junction temperature.
- ②  $V_{DD} = 50V$ , starting  $T_J = 25^{\circ}C$ ,  $L = 1.5\text{ mH}$   
Peak  $I_L = 26A$ ,  $V_{GS} = 12V$
- ③  $I_{SD} \leq 26A$ ,  $di/dt \leq 400A/\mu s$ ,  
 $V_{DD} \leq 200V$ ,  $T_J \leq 150^{\circ}C$
- ④ Pulse width  $\leq 300\ \mu s$ ; Duty Cycle  $\leq 2\%$
- ⑤ **Total Dose Irradiation with  $V_{GS}$  Bias.**  
12 volt  $V_{GS}$  applied and  $V_{DS} = 0$  during irradiation per MIL-STD-750, method 1019, condition A.
- ⑥ **Total Dose Irradiation with  $V_{DS}$  Bias.**  
160volt  $V_{DS}$  applied and  $V_{GS} = 0$  during irradiation per MIL-STD-750, method 1019, condition A.

**Case Outline and Dimensions —TO-204AE (Modified TO-3)**



PIN ASSIGNMENTS

- 1 - SOURCE
- 2 - GATE
- 3 - DRAIN (CASE)

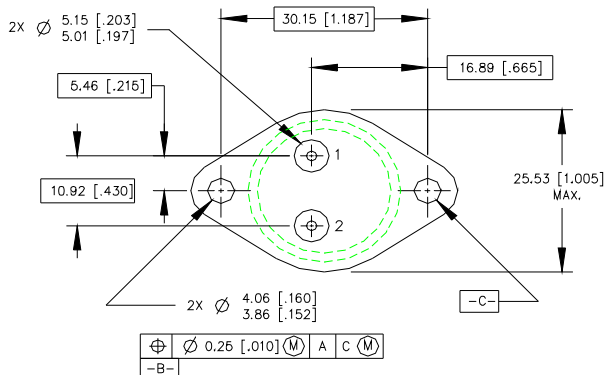

NOTES:

1. DIMENSIONING & TOLERANCING PER ANSI Y14.6M-1982.
2. CONTROLLING DIMENSION: INCH.
3. DIMENSIONS ARE SHOWN IN MILLIMETERS [INCHES].
4. OUTLINE CONFORMS TO JEDEC OUTLINE TO-204AE.

International  
**IR** Rectifier

IR WORLD HEADQUARTERS: 233 Kansas St., El Segundo, California 90245, USA Tel: (310) 252-7105  
TAC Fax: (310) 252-7903

Visit us at [www.irf.com](http://www.irf.com) for sales contact information.  
Data and specifications subject to change without notice. 05/01