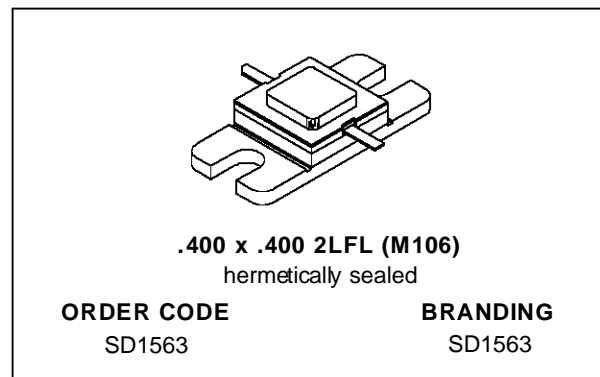
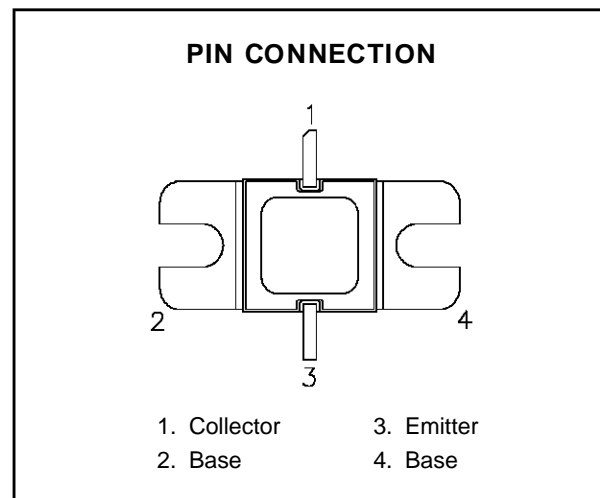

**RF & MICROWAVE TRANSISTORS
UHF PULSED APPLICATIONS**

- 350 WATTS @ 10 μ SEC PULSE WIDTH, 10% DUTY CYCLE
- 300 WATTS @ 250 μ SEC PULSE WIDTH, 10% DUTY CYCLE
- 9.5 dB MIN. GAIN
- REFRACTORY GOLD METALLIZATION
- EMITTER BALLASTING AND LOW THERMAL RESISTANCE FOR RELIABILITY AND RUGGEDNESS
- INFINITE VSWR CAPABILITY AT SPECIFIED OPERATING CONDITIONS

DESCRIPTION

The SD1563 is a gold metallized silicon NPN pulse power transistor. The SD1563 is designed for applications requiring high peak power and low duty cycles within the frequency range of 400 - 500 MHz.

ABSOLUTE MAXIMUM RATINGS ($T_{case} = 25^{\circ}C$)

Symbol	Parameter	Value	Unit
V_{CBO}	Collector-Base Voltage	65	V
V_{CES}	Collector-Emitter Voltage	65	V
V_{EBO}	Emitter-Base Voltage	3.5	V
I_C	Device Current	21.6	A
P_{DISS}	Power Dissipation	875	W
T_J	Junction Temperature	+200	$^{\circ}C$
T_{STG}	Storage Temperature	- 65 to +150	$^{\circ}C$

THERMAL DATA

$R_{TH(j-c)}$	Junction-Case Thermal Resistance	0.2	$^{\circ}C/W$
---------------	----------------------------------	-----	---------------

SD1563

ELECTRICAL SPECIFICATIONS ($T_{\text{case}} = 25^{\circ}\text{C}$)

STATIC

Symbol	Test Conditions		Value			Unit
			Min.	Typ.	Max.	
BV_{CBO}	$I_{\text{C}} = 50 \text{ mA}$	$I_{\text{E}} = 0 \text{ mA}$	65	—	—	V
BV_{CES}	$I_{\text{C}} = 50 \text{ mA}$	$V_{\text{BE}} = 0 \text{ V}$	65	—	—	V
BV_{CEO}	$I_{\text{C}} = 50 \text{ mA}$	$I_{\text{B}} = 0 \text{ mA}$	28	—	—	V
BV_{EBO}	$I_{\text{E}} = 10 \text{ mA}$	$I_{\text{C}} = 0 \text{ mA}$	3.5	—	—	V
I_{CES}	$V_{\text{CE}} = 30 \text{ V}$	$I_{\text{E}} = 0 \text{ mA}$	—	—	7.5	mA
h_{FE}	$V_{\text{CE}} = 5 \text{ V}$	$I_{\text{C}} = 5 \text{ A}$	10	—	100	—

DYNAMIC

Symbol	Test Conditions			Value			Unit
				Min.	Typ.	Max.	
P_{OUT}	$f = 425 \text{ MHz}$	$P_{\text{IN}} = 33.5 \text{ W}$	$V_{\text{CE}} = 40 \text{ V}$	300	—	—	W
P_{G}	$f = 425 \text{ MHz}$	$P_{\text{OUT}} = 300 \text{ W}$	$V_{\text{CE}} = 40 \text{ V}$	9.5	—	—	dB
η_{C}	$f = 425 \text{ MHz}$	$P_{\text{IN}} = 25 \text{ W}$	$V_{\text{CE}} = 40 \text{ V}$	55	—	—	%

Note: Pulse Width = 250 μ Sec, Duty Cycle = 10%

TYPICAL PERFORMANCE

P_{OUT} (W)	P.W. (μ Sec)	D.C. (%)	T_{J} ($^{\circ}\text{C}$ max.)	V_{CC}
360	10	10	150	40
350	20	10	150	40
325	100	10	150	40
310	500	10	150	40
300	1000	10	150	40

TYPICAL PERFORMANCE (P.W. = 120 μ Sec)

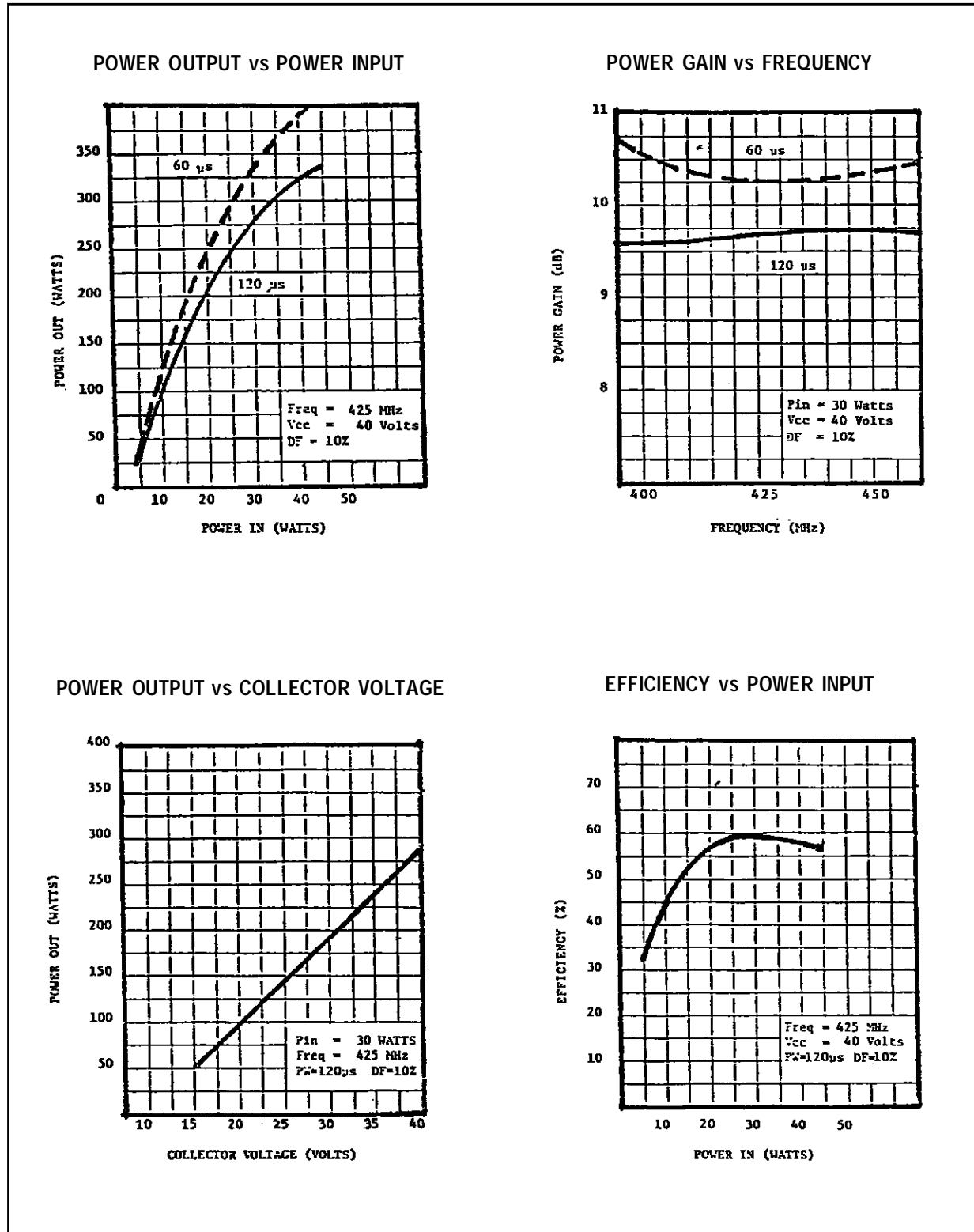

TYPICAL PERFORMANCE (P.W. = 120μSec)

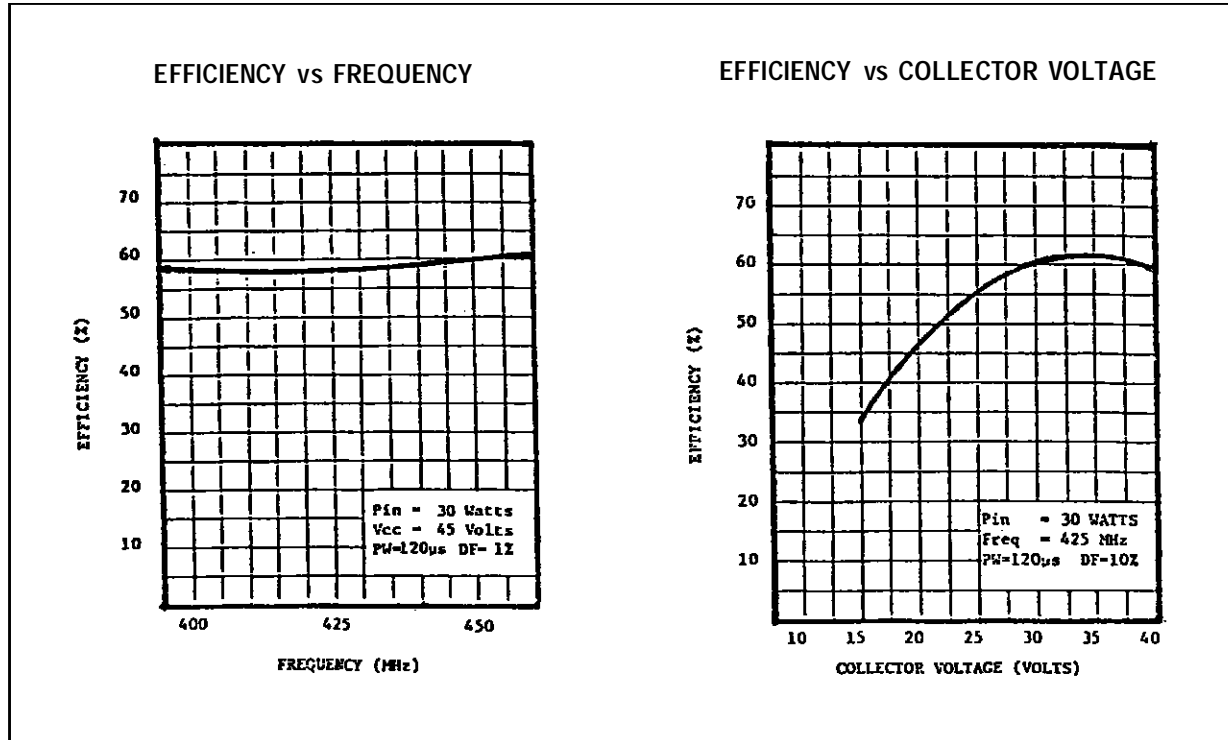

IMPEDANCE DATA (P.W. = 120μSec)

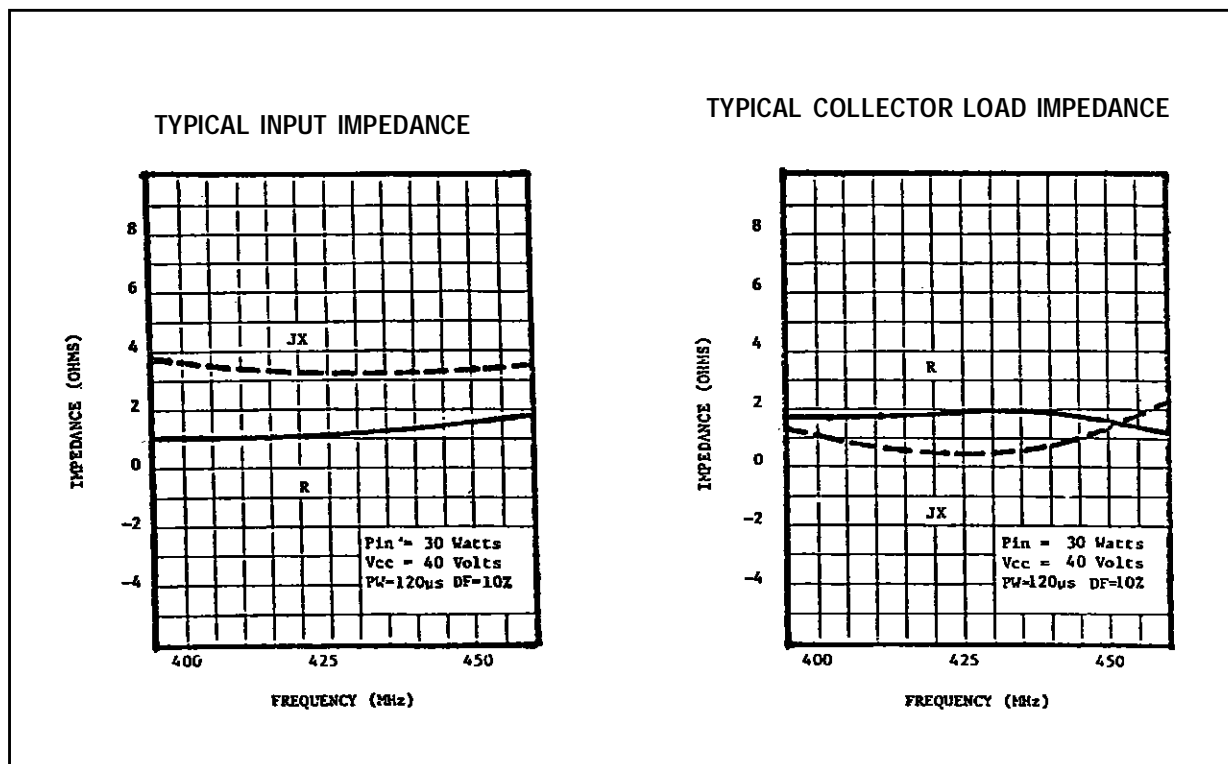

TYPICAL PERFORMANCE (P.W. = 250 μ Sec)

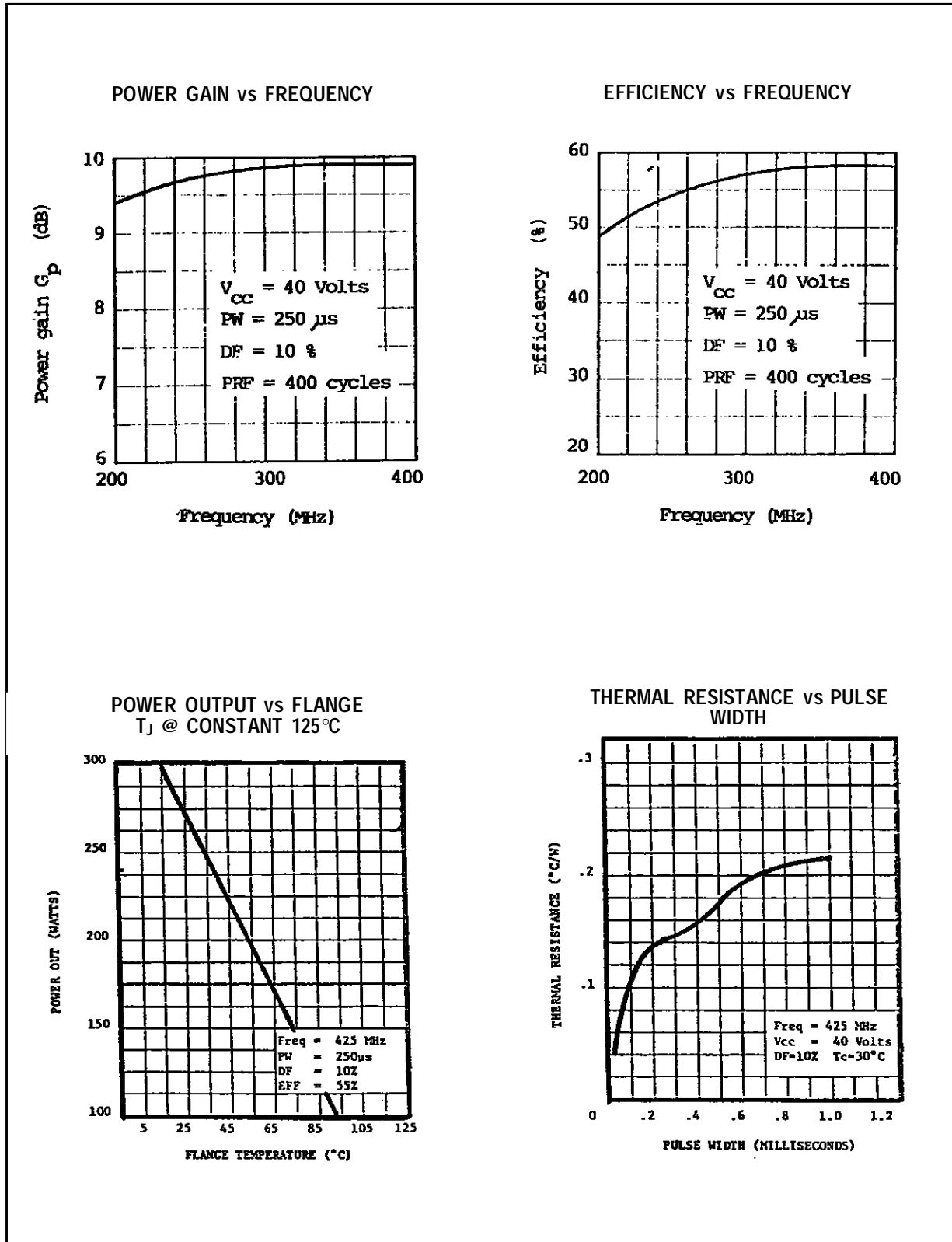

IMPEDANCE DATA (P.W. = 250 μ Sec)

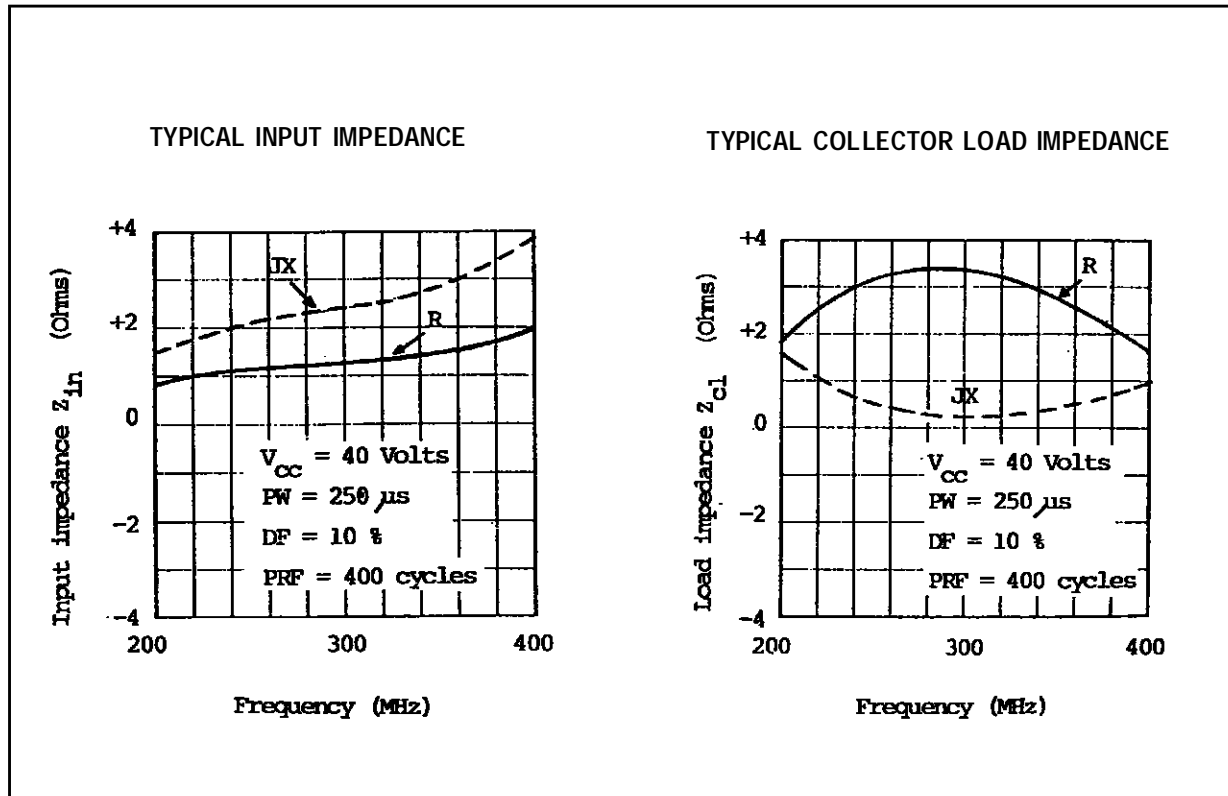

PACKAGE MECHANICAL DATA

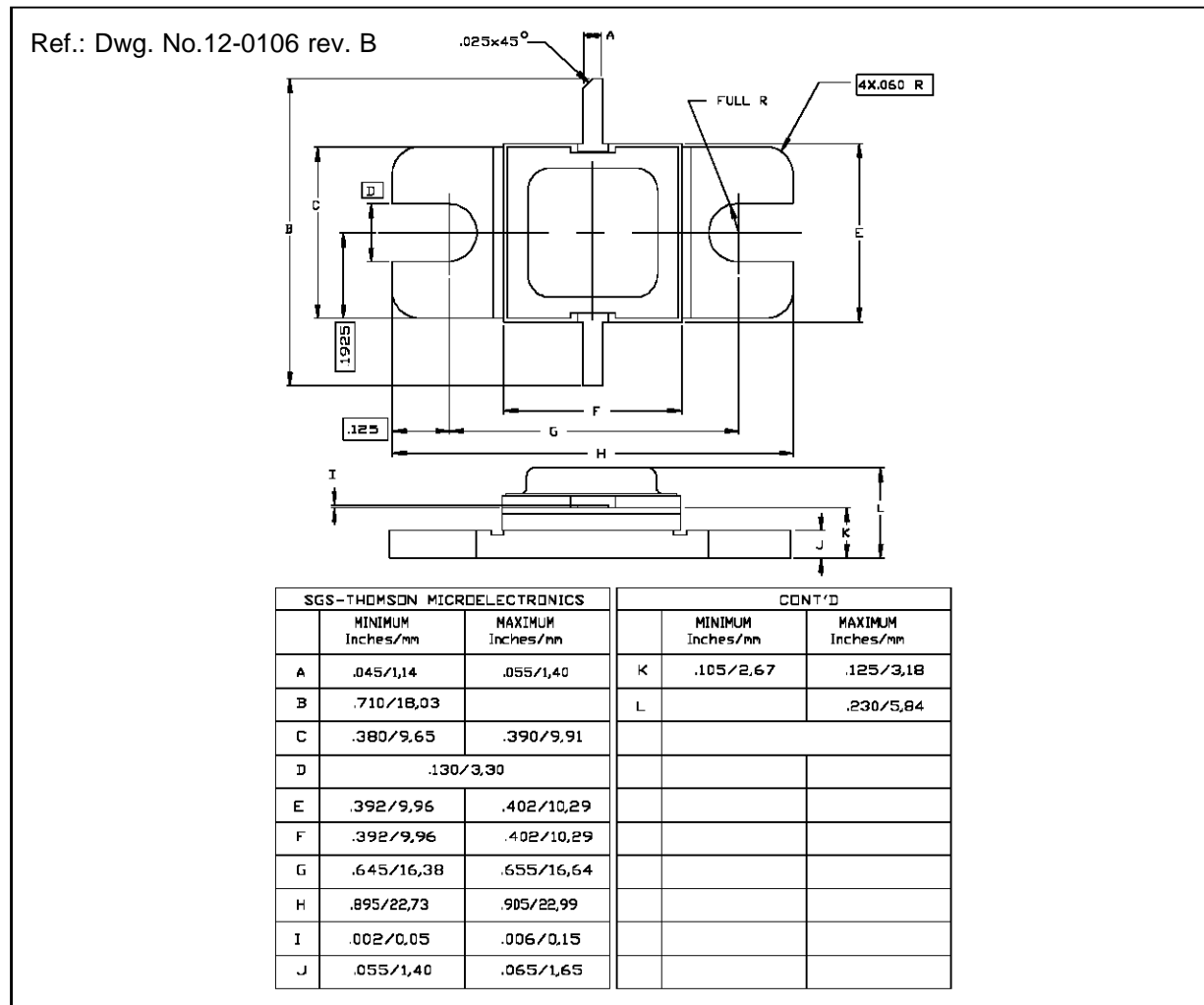

Information furnished is believed to be accurate and reliable. However, SGS-THOMSON Microelectronics assumes no responsibility for the consequences of use of such information nor for any infringement of patents or other rights of third parties which may result from its use. No license is granted by implication or otherwise under any patent or patent rights of SGS-THOMSON Microelectronics. Specifications mentioned in this publication are subject to change without notice. This publication supersedes and replaces all information previously supplied. SGS-THOMSON Microelectronics products are not authorized for use as critical components in life support devices or systems without express written approval of SGS-THOMSON Microelectronics.

©1994 SGS-THOMSON Microelectronics - All Rights Reserved

SGS-THOMSON Microelectronics GROUP OF COMPANIES

Australia - Brazil - France - Germany - Hong Kong - Italy - Japan - Korea - Malaysia - Malta - Morocco - The Netherlands - Singapore - Spain - Sweden - Switzerland - Taiwan - Thailand - United Kingdom - U.S.A.