

DC/DC CONVERTER CONTROL IC

■ GENERAL DESCRIPTION

The NJM 2360 is a DC to DC converter control IC. Due to the internalization of a high current output switch, 1.5A switching operations are available. The NJM2360 is designed to be incorporated in step-up, step-down and inverting applications with a minimum number of external components. Output current is limited by an external resistor.

■ PACKAGE OUTLINE

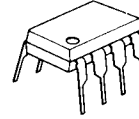

NJM2360D



NJM2360M

■ FEATURES

- Operating Voltage (2.5V to 40V)
- Low Standby Current
- Current Limiting
- Output Switch Current to 1.5A
- Supply Voltage V^+ 2.5 to 40V
- Output Voltage V_{OR} 1.25 to 40V
- Oscillator Frequency f_{OSC} 100Hz to 100kHz
- Package Outline DIP8, DMP8
- Bipolar Technology

■ PIN CONFIGURATION

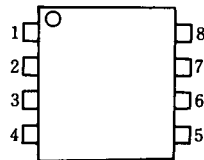

NJM2360D
NJM2360M

PIN FUNCTION

1. C_S
2. E_S
3. C_T
4. GND
5. INV_{IN}
6. V^+
7. S_I
8. C_D

■ BLOCK DIAGRAM

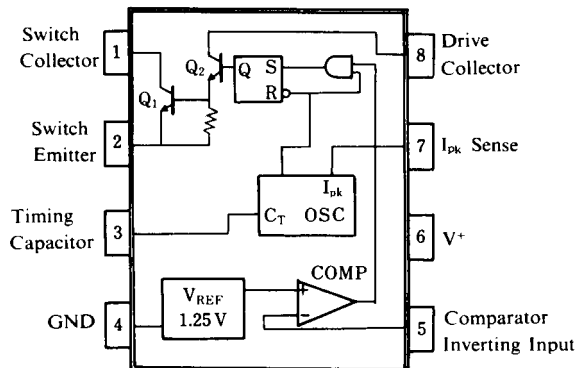

NJM2360

■ ABSOLUTE MAXIMUM RATINGS

(T_a = 25°C)

PARAMETER	SYMBOL	RATINGS	UNIT
Supply Voltage	V ⁺	40	V
Comparator Input Voltage Range	V _{IR}	-0.3 to V ⁺	V
Power Dissipation	P _D	(DIP8) 700 (DMP8) 600 (note1)	mW mW
Switch Current	I _{SW}	1.5	A
Operating Temperature Range	T _{opr}	-40 to +85	°C
Storage Temperature Range	T _{stg}	-40 to +125	°C

(note 1) At on PC board

■ ELECTRICAL CHARACTERISTICS

● DC Characteristics (V⁺ = 5V, T_a = 25°C)

PARAMETER	SYMBOL	TEST CONDITION	MIN.	TYP.	MAX.	UNIT
Operating Current	I _{CC}	5V ≤ V ⁺ ≤ 40V, C _T = 0.001μF S _I = V ⁺ , INV _{IN} > V _{th} , E _S = GND	-	2.4	3.5	mA

Oscillator

Charge Current	I _{chg}	5V ≤ V ⁺ ≤ 40V	20	35	50	μA
Discharge Current	I _{dischg}	5V ≤ V ⁺ ≤ 40V	150	200	250	μA
Voltage Swing	V _{OSC}		-	0.5	-	V _{P-P}
Discharge to Charge Current Ratio	I _{dischg} /I _{chg}	S _I = V ⁺	-	6	-	-
Peak Current Sense Voltage	V _{IPK(sense)}	I _{chg} = I _{dischg}	250	300	350	mV

Output Switch (Note 2)

Saturation Voltage 1	V _{CE(sat) 1}	Darlington Connection (C _S = C _D) I _{SW} = 1.0A	-	1.0	1.3	V
Saturation Voltage 2	V _{CE(sat) 2}	I _{SW} = 1.0A, I _{C(driver)} = 50mA (Forced β ≒ 20)	-	0.5	0.7	V
DC Current Gain	h _{FE}	I _{SW} = 1.0A, V _{CE} = 5.0V	35	120	-	-
Collector Off-State Current	I _{C(off)}	V _{CE} = 40V	-	10	-	nA

Comparator

Threshold Voltage	V _{th}		1.18	1.25	1.32	V
Input Bias Current	I _{IB}	V _{IN} = 0V	-	40	400	nA

Note 2 : Output switch tests are performed under pulsed conditions to minimize power dissipation.

■ TYPICAL APPLICATION

1. Step-Up Converter

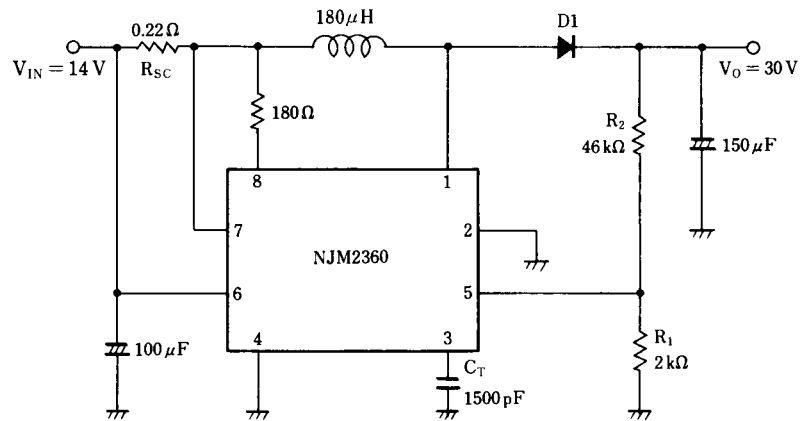

*D1 : SBD (EK14)

2. Step-Down Converter

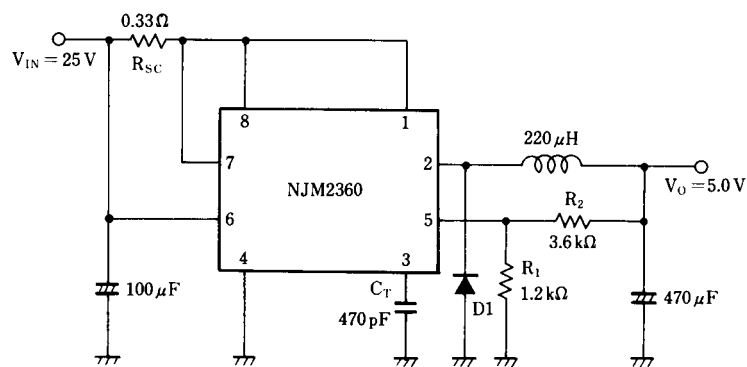

*D1 : SBD (EK14)

NJM2360

■ TYPICAL APPLICATIONS

3. Step-Up Converter (High Current)

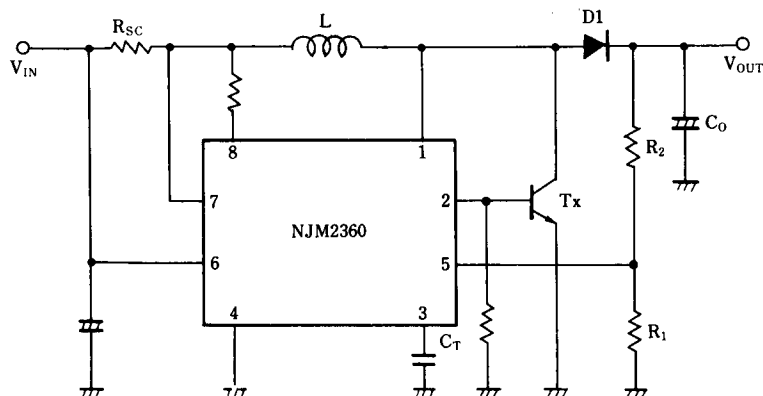

4. Step-Down Converter (High Current)

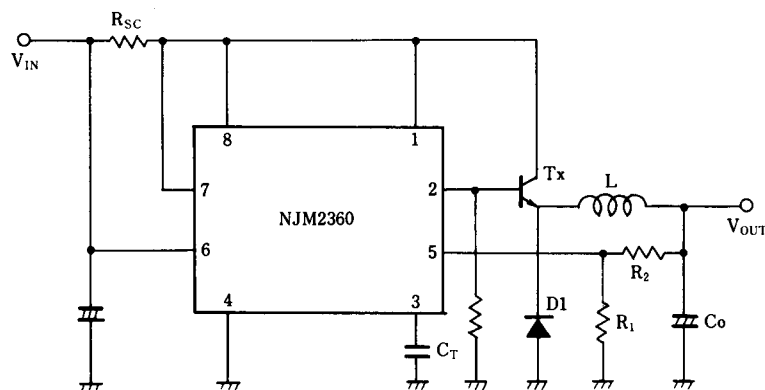

5. Inverting Converter

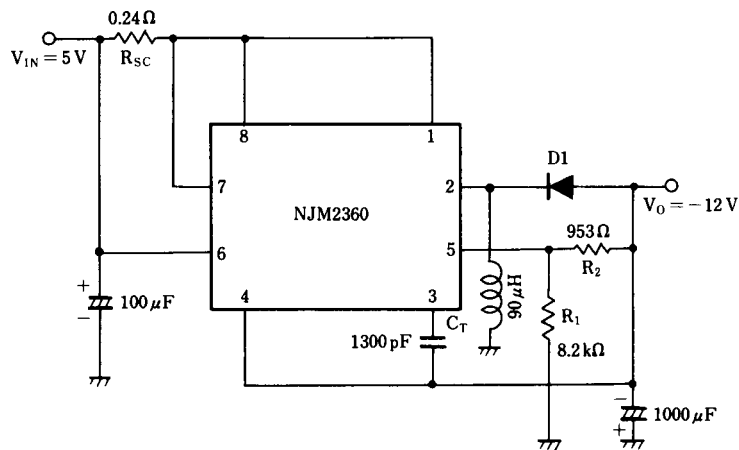

*D1 : SBD (EK14)

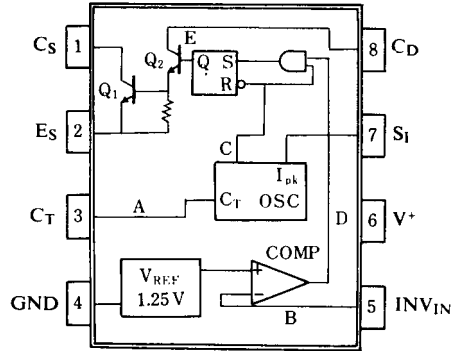

Fig. 1 Block Diagram

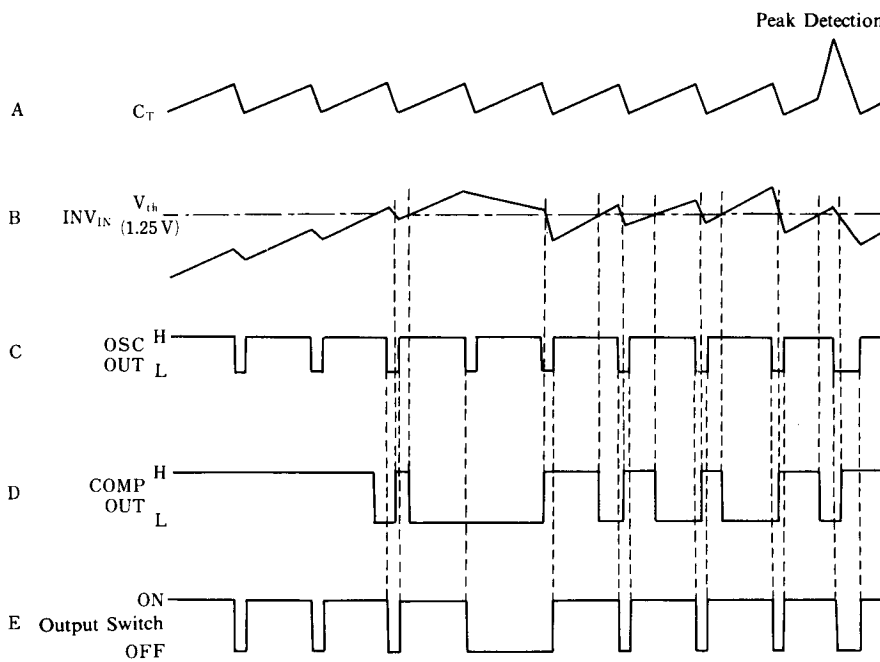
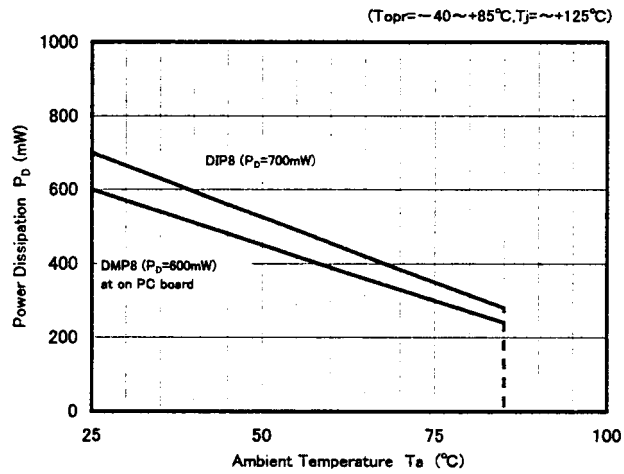

Fig. 2 Timing Chart

■ POWER DISSIPATION VS. TEMPERATURE



■ TYPICAL CHARACTERISTICS

Oscillator Frequency vs. Timing Capacitor

($V_{IN} = 5V$, $S_1 = V^+$, Pin5 = GND, $T_a = 25^\circ C$)

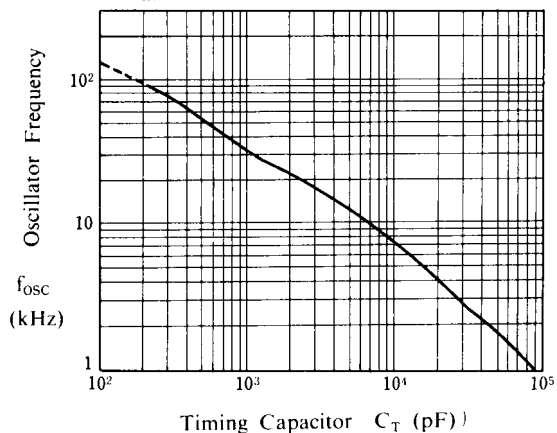

Switching Time vs. Timing Capacitor

($V_{IN} = 5V$, $S_1 = V^+$, Pin5 = GND, $T_a = 25^\circ C$)

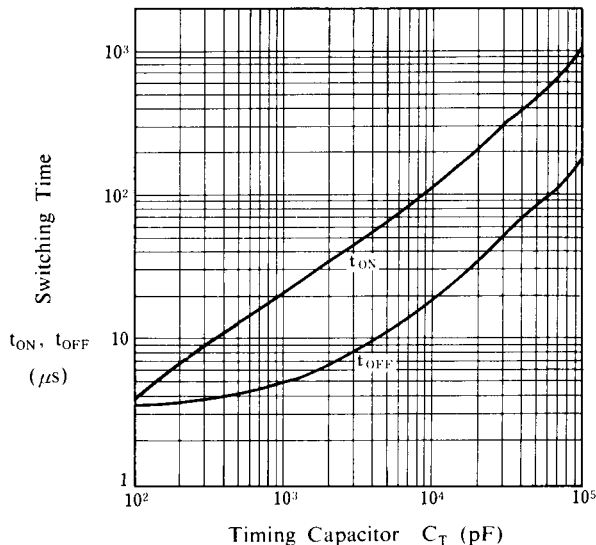

Operating Current vs. Operating Voltage

($C_T = 0.001 \mu F$, $S_1 = V^+$, Pin2 = GND, $T_a = 25^\circ C$)

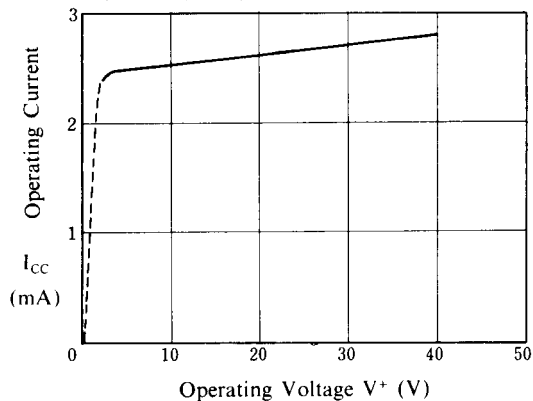

Switch Saturation Voltage 2 vs. Collector Current ($\beta=20$)

($V_{CE} = 5V$, Pin7 = V^+ , Pin2·3·5 = GND, $T_a = 25^\circ C$)

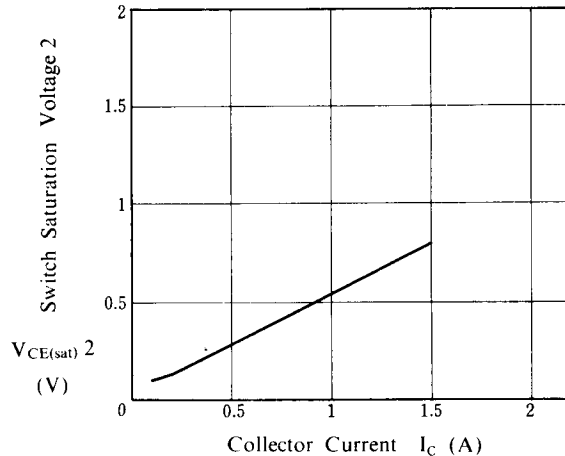

Switch Saturation Voltage 1 vs. Collector Current (Darlington)

($V_{CE} = 5V$, Pin7 = V^+ , Pin2·3·5 = GND, $T_a = 25^\circ C$)

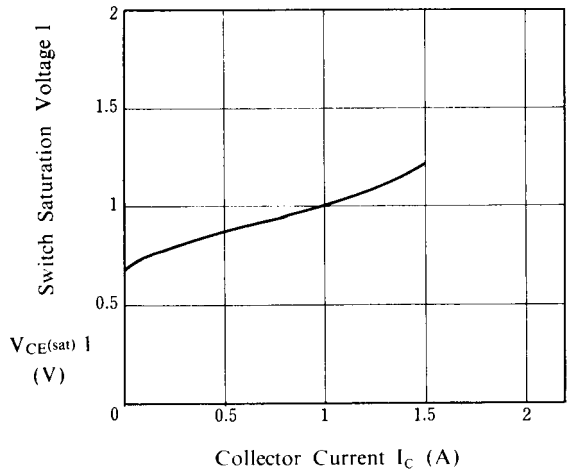

Saturation Voltage 1 vs. Temperature

($V^+ = 5V$, $I_{sw} = 1.0A$, Darlington)

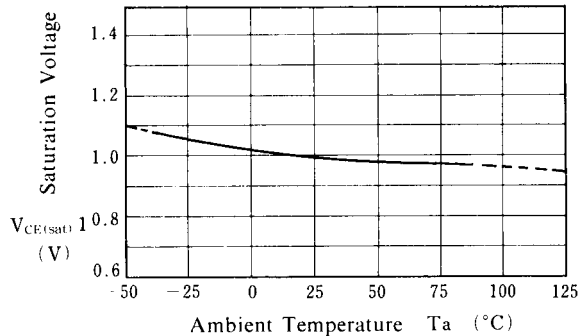

■ TYPICAL CHARACTERISTICS

Saturation Voltage 2 vs. Temperature

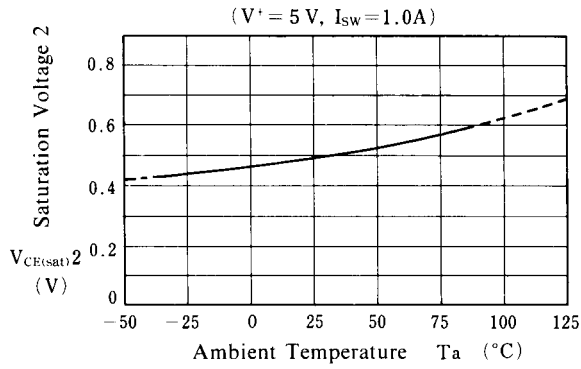

Operating Current vs. Temperature

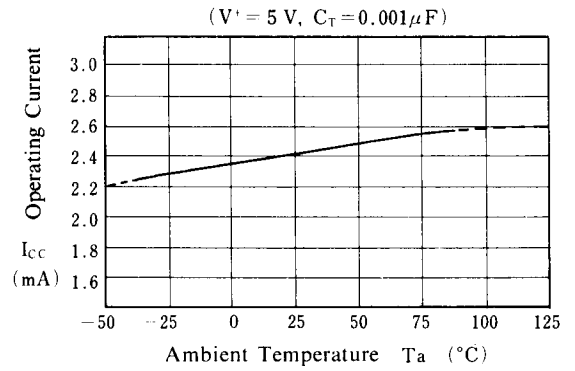

Discharge to Charge Current Ratio vs. Temperature

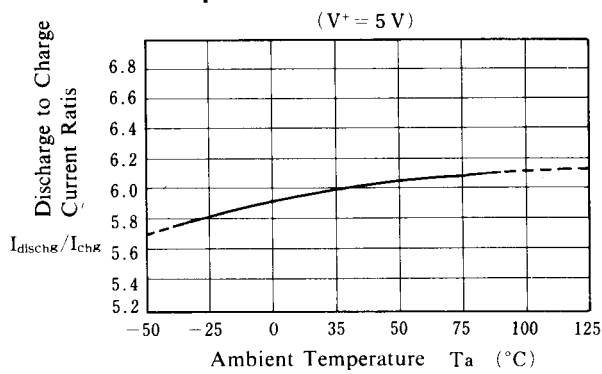

Threshold Voltage vs. Temperature

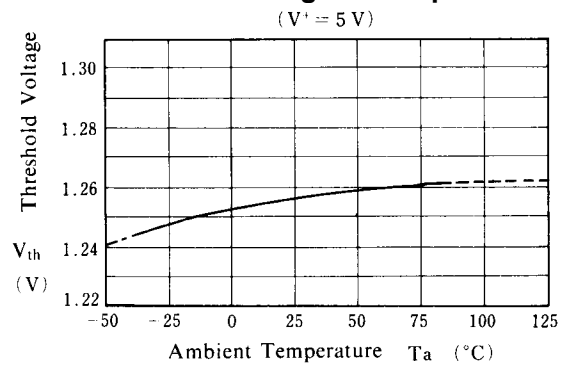

■ TYPICAL CHARACTERISTICS (Application)

1. Step-Up Converter

Output Voltage vs. Input Voltage

($V_O = 30\text{ V}$, $I_O = 100\text{ mA}$, $C_T = 1500\text{ pF}$,
 $L = 180\text{ }\mu\text{H}$, $T_a = 25\text{ }^\circ\text{C}$)

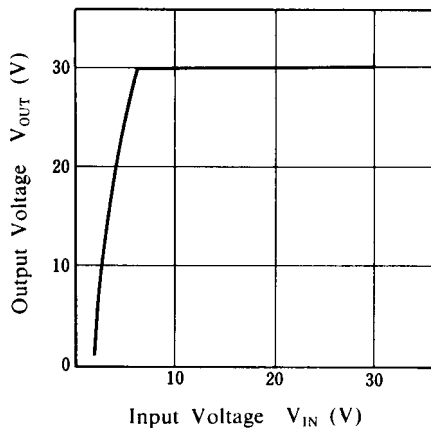

Output Voltage vs. Output Current

($V_{IN} = 14\text{ V}$, $V_O = 30\text{ V}$, $C_T = 1500\text{ pF}$,
 $L = 180\text{ }\mu\text{H}$, $T_a = 25\text{ }^\circ\text{C}$)

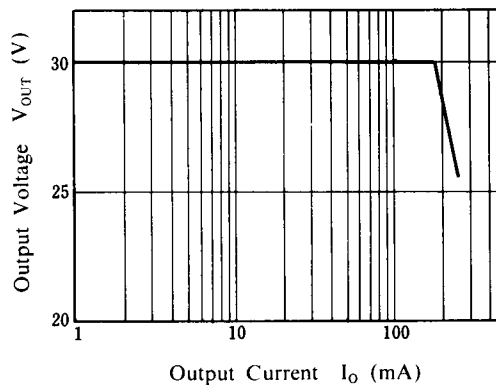

2. Step-Down Converter

Output Voltage vs. Input Voltage

($V_O = 5\text{ V}$, $I_O = 500\text{ mA}$, $C_T = 470\text{ pF}$,
 $L = 220\text{ }\mu\text{H}$, $T_a = 25\text{ }^\circ\text{C}$)

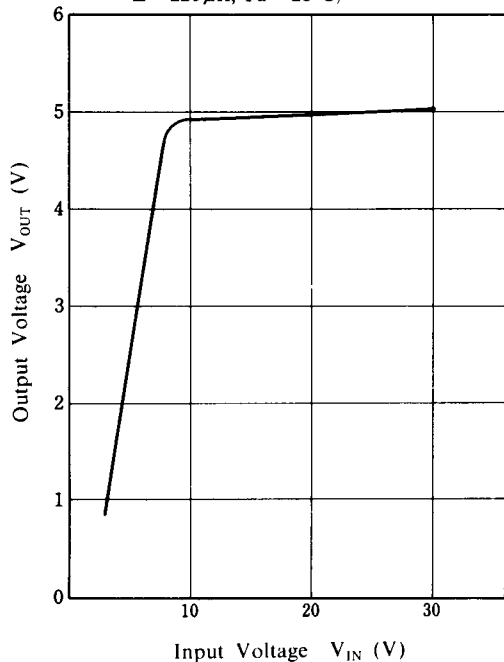

Output Voltage vs. Output Current

($V_{IN} = 25\text{ V}$, $V_O = 5\text{ V}$, $C_T = 470\text{ pF}$,
 $L = 220\text{ }\mu\text{H}$, $T_a = 25\text{ }^\circ\text{C}$)

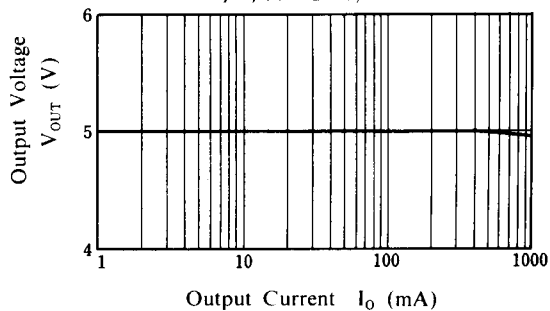

[CAUTION]

The specifications on this databook are only given for information, without any guarantee as regards either mistakes or omissions. The application circuits in this databook are described only to show representative usages of the product and not intended for the guarantee or permission of any right including the industrial rights.