

OCTAL D-TYPE FLIP-FLOP; POSITIVE EDGE-TRIGGER; 3-STATE

FEATURES

- 3-state non-inverting outputs for bus oriented applications
- 8-bit positive edge-triggered register
- Common 3-state output enable input
- Independent register and 3-state buffer operation
- Output capability: bus driver
- I²C category: MSI

GENERAL DESCRIPTION

The 74HC/HCT574 are high-speed Si-gate CMOS devices and are pin compatible with low power Schottky TTL (LSTTL). They are specified in compliance with JEDEC standard no. 7A. The 74HC/HCT574 are octal D-type flip-flops featuring separate D-type inputs for each flip-flop and non-inverting 3-state outputs for bus oriented applications. A clock (CP) and an output enable (\overline{OE}) input are common to all flip-flops. The 8 flip-flops will store the state of their individual D-inputs that meet the set-up and hold time requirements on the LOW-to-HIGH CP transition. When \overline{OE} is LOW, the contents of the 8 flip-flops are available at the outputs. When \overline{OE} is HIGH, the outputs go to the high impedance OFF-state. Operation of the \overline{OE} input does not affect the state of the flip-flops. The "574" is functionally identical to the "564", but has non-inverting outputs. The "574" is functionally identical to the "374", but has a different pinning.

SYMBOL	PARAMETER	CONDITIONS	TYPICAL		UNIT
			HC	HCT	
t _{PHL} / t _{PLH}	propagation delay CP to Q _n	C _L = 15 pF V _{CC} = 5 V	14	15	ns
f _{max}	maximum clock frequency		123	76	MHz
C _I	input capacitance		3.5	3.5	pF
C _{PD}	power dissipation capacitance per flip-flop	notes 1 and 2	22	25	pF

GND = 0 V; T_{amb} = 25 °C; t_r = t_f = 6 ns

Notes

1. C_{PD} is used to determine the dynamic power dissipation (P_D in μW):

$$P_D = C_{PD} \times V_{CC}^2 \times f_i + \sum (C_L \times V_{CC}^2 \times f_o)$$
 where:
 f_i = input frequency in MHz
 f_o = output frequency in MHz
 $\sum (C_L \times V_{CC}^2 \times f_o)$ = sum of outputs
 C_L = output load capacitance in pF
 V_{CC} = supply voltage in V
2. For HC the condition is V_I = GND to V_{CC}
 For HCT the condition is V_I = GND to V_{CC} - 1.5 V

PACKAGE OUTLINES

20-lead DIL; plastic (SOT146).
20-mini-pack; plastic (SO20; SOT163A).

PIN DESCRIPTION

PIN NO.	SYMBOL	NAME AND FUNCTION
1	\overline{OE}	3-state output enable input (active LOW)
2, 3, 4, 5, 6, 7, 8, 9	D ₀ to D ₇	data inputs
10	GND	ground (0 V)
11	CP	clock input (LOW-to-HIGH, edge-triggered)
19, 18, 17, 16, 15, 14, 13, 12	Q ₀ to Q ₇	3-state flip-flop outputs
20	V _{CC}	positive supply voltage

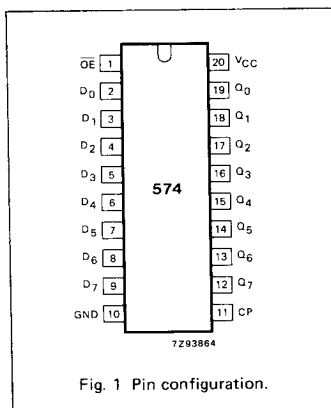

Fig. 1 Pin configuration.

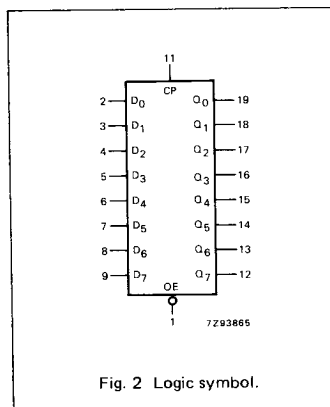

Fig. 2 Logic symbol.

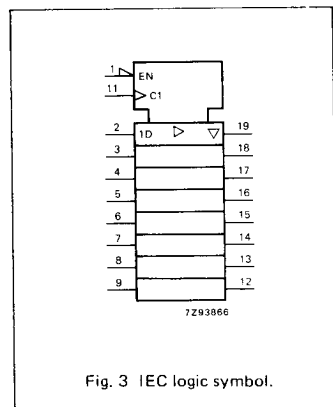

Fig. 3 IEC logic symbol.

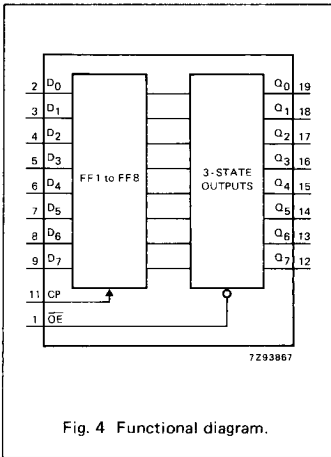

Fig. 4 Functional diagram.

FUNCTION TABLE

OPERATING MODES	INPUTS			INTERNAL FLIP-FLOPS	OUTPUTS Q ₀ to Q ₇
	\overline{OE}	CP	D _n		
load and read register	L	↑	l	L	L
	L	↑	h	H	H
load register and disable outputs	H	↑	l	L	Z
	H	↑	h	H	Z

H = HIGH voltage level
h = HIGH voltage level one set-up time prior to the LOW-to-HIGH CP transition
L = LOW voltage level
l = LOW voltage level one set-up time prior to the LOW-to-HIGH CP transition
Z = high impedance OFF-state
↑ = LOW-to-HIGH clock transition

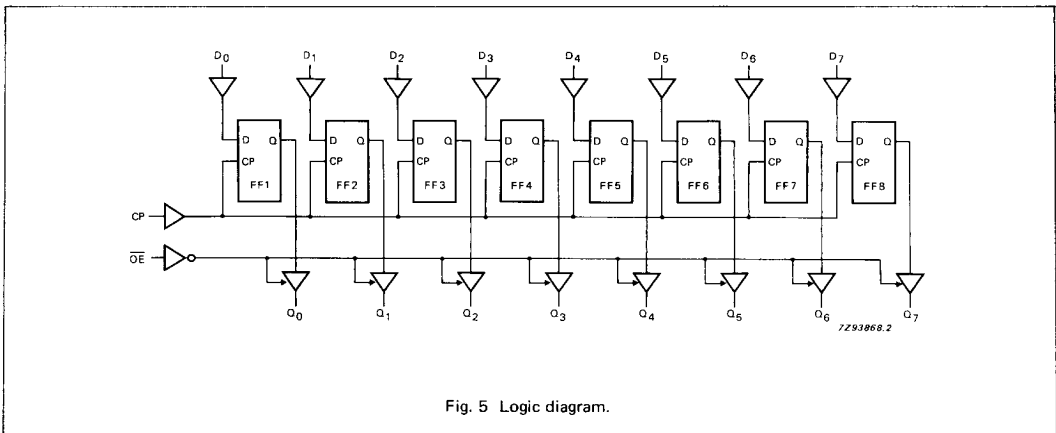

Fig. 5 Logic diagram.

DC CHARACTERISTICS FOR 74HC

For the DC characteristics see chapter "HCMOS family characteristics", section "Family specifications".

Output capability: bus driver

I_{CC} category: MSI**AC CHARACTERISTICS FOR 74HC**GND = 0 V; t_r = t_f = 6 ns; C_L = 50 pF

SYMBOL	PARAMETER	T _{amb} (°C)						UNIT	TEST CONDITIONS		
		74HC							V _{CC} V	WAVEFORMS	
		+25			-40 to +85		-40 to +125				
		min.	typ.	max.	min.	max.	min.				max.
t _{PHL} / t _{PLH}	propagation delay CP to Q _n		47 17 14	150 30 26		190 35 33		225 45 38	ns	2.0 4.5 6.0	Fig. 6
t _{pZH} / t _{pZL}	3-state output enable time OE to Q _n		44 16 13	140 28 24		175 35 30		210 42 36	ns	2.0 4.5 6.0	Fig. 7
t _{PHZ} / t _{PLZ}	3-state output disable time OE to Q _n		39 14 11	125 25 21		155 31 26		190 38 32	ns	2.0 4.5 6.0	Fig. 7
t _{THL} / t _{TLH}	output transition time		14 5 4	60 12 10		75 15 13		90 18 15	ns	2.0 4.5 6.0	Fig. 6
t _w	clock pulse width HIGH or LOW	80 16 14	14 5 4		100 20 17		120 24 20		ns	2.0 4.5 6.0	Fig. 6
t _{su}	set-up time D _n to CP	60 12 10	6 2 2		75 15 13		90 18 15		ns	2.0 4.5 6.0	Fig. 8
t _h	hold time D _n to CP	5 5 5	0 0 0		5 5 5		5 5 5		ns	2.0 4.5 6.0	Fig. 8
f _{max}	maximum clock pulse frequency	6.0 30 35	37 112 133		4.8 24 28		4.0 20 24		MHz	2.0 4.5 6.0	Fig. 6

DC CHARACTERISTICS FOR 74HCT

For the DC characteristics see chapter "HCMOS family characteristics", section "Family specifications".

Output capability: bus driver

I_{CC} category: MSI

Note to HCT types

The value of additional quiescent supply current (ΔI_{CC}) for a unit load of 1 is given in the family specifications.

To determine ΔI_{CC} per input, multiply this value by the unit load coefficient shown in the table below.

INPUT	UNIT LOAD COEFFICIENT
D _n	0.5
OE	1.25
CP	1.5

AC CHARACTERISTICS FOR 74HCT

GND = 0 V; t_r = t_f = 6 ns; C_L = 50 pF

SYMBOL	PARAMETER	T _{amb} (°C)						UNIT	TEST CONDITIONS		
		74HCT							V _{CC} V	WAVEFORMS	
		+25			-40 to +85		-40 to +125				
		min.	typ.	max.	min.	max.	min.				max.
t _{PHL} / t _{PLH}	propagation delay CP to Q _n		18	33		41		50	ns	4.5	Fig. 6
t _{PZH} / t _{PZL}	3-state output enable time OE to Q _n		19	33		41		50	ns	4.5	Fig. 7
t _{PHZ} / t _{PLZ}	3-state output disable time OE to Q _n		16	28		35		42	ns	4.5	Fig. 7
t _{THL} / t _{TTLH}	output transition time		5	12		15		18	ns	4.5	Fig. 6
t _W	clock pulse width HIGH or LOW	16	7		20		24		ns	4.5	Fig. 6
t _{su}	set-up time D _n to CP	12	3		15		18		ns	4.5	Fig. 8
t _h	hold time D _n to CP	5	-1		5		5		ns	4.5	Fig. 8
f _{max}	maximum clock pulse frequency	30	69		24		20		MHz	4.5	Fig. 6

AC WAVEFORMS

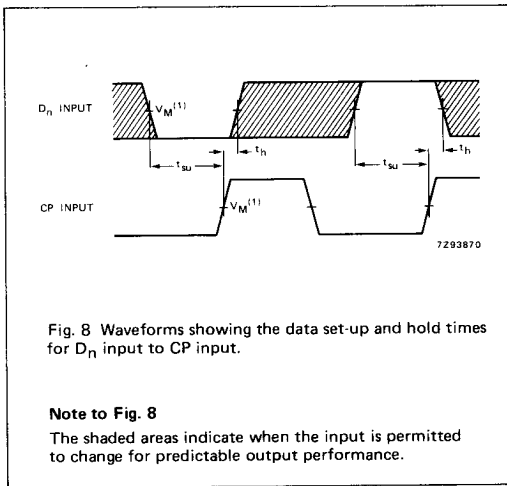
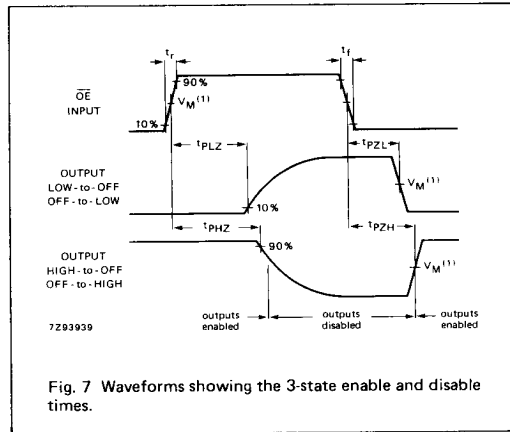
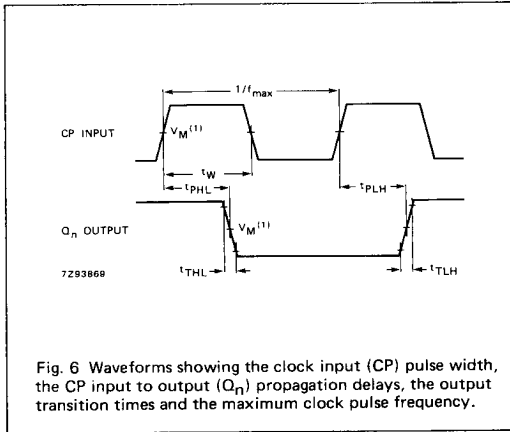

Note to AC waveforms

(1) HC : $V_M = 50\%$; $V_1 = \text{GND to } V_{CC}$.
HCT: $V_M = 1.3 \text{ V}$; $V_1 = \text{GND to } 3 \text{ V}$.