

3421 AND 3422

PRELIMINARY INFORMATION
(subject to change without notice)
February 11, 1999

HALL-EFFECT, DIRECTION-DETECTION SENSORS

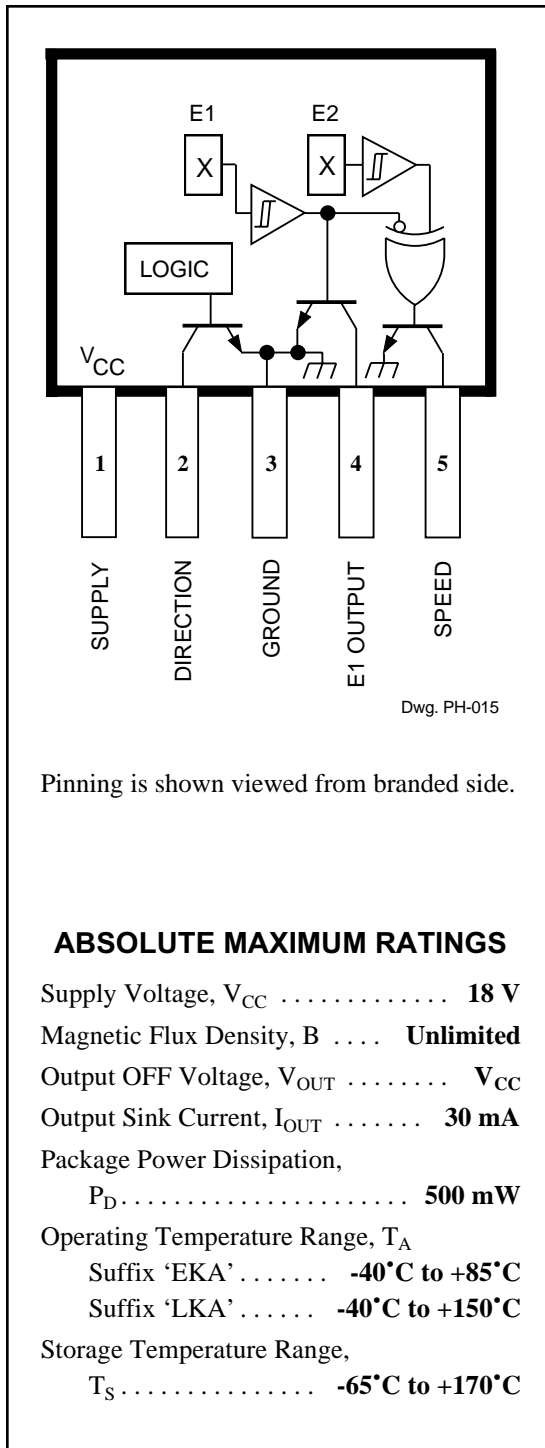

Pinning is shown viewed from branded side.

ABSOLUTE MAXIMUM RATINGS

Supply Voltage, V_{CC} **18 V**
 Magnetic Flux Density, B **Unlimited**
 Output OFF Voltage, V_{OUT} V_{CC}
 Output Sink Current, I_{OUT} **30 mA**
 Package Power Dissipation,
 P_D **500 mW**
 Operating Temperature Range, T_A
 Suffix 'EKA' **-40°C to +85°C**
 Suffix 'LKA' **-40°C to +150°C**
 Storage Temperature Range,
 T_S **-65°C to +170°C**

The A3421xKA and A3422xKA Hall-effect, direction-detection sensors are a new generation of special function integrated sensors that are capable of sensing the direction of rotation of a ring magnet. These transducers provide separate digital outputs that provide information on magnet rotation speed, direction, and magnet pole count. These devices eliminate the major manufacturing hurdles encountered in fine-pitch direction-detection applications, namely maintaining accurate mechanical location between the two active Hall elements. Here, the two Hall elements are photolithographically aligned to better than 1 μm , as contrasted with 100 μm or worse mechanical location tolerance when manufactured discretely. These highly sensitive, temperature-stable, magnetic transducers are ideal for use in digital-encoder systems in the harsh environments of automotive or industrial applications. The A3421xKA is a high-hysteresis device designed for low-resolution pulse counting while the A3422xKA is a high-sensitivity device optimized for use with high-density magnets.

The A3421xKA and A3422xKA monolithic integrated circuits contain two independent Hall-effect latches whose digital outputs are internally coupled to CMOS logic circuitry that decodes signal speed and direction. Extremely low-drift BiCMOS circuitry is used for the amplifiers to ensure symmetry between the two latches so that signal quadrature can be maintained. An on-chip voltage regulator allows the use of these devices from a 4.5 V to 18 V supply. Both devices have standard open-collector outputs; the logic operation of both devices is the same.

Two operating temperature ranges are provided; suffix 'E-' is for the automotive and industrial temperature range of -40°C to +85°C, suffix 'L-' is for the automotive and military temperature range of -40°C to +150°C. The 5-pin 'KA' SIP package provides a cost-competitive solution to linear magnetic sensing in harsh environments.

FEATURES

- Internal Direction-Decoding Circuitry
- Two Matched Hall Latches On A Single Substrate
- Superior Temperature Stability
- 4.5 V to 18 V Operation
- Electrically Defined Power-On State
- Under-Voltage Lockout

Always order by complete part number, e.g., **A3421EKA**.

3421 AND 3422 HALL-EFFECT, DIRECTION-DETECTION SENSORS

FUNCTIONAL BLOCK DIAGRAM

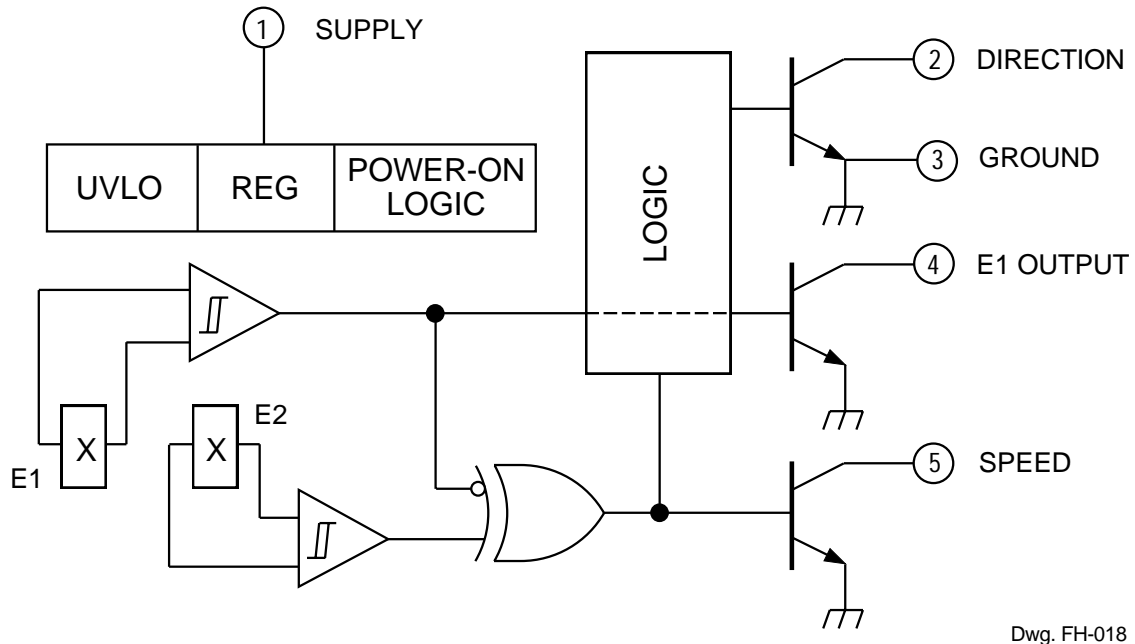

TIMING DIAGRAM

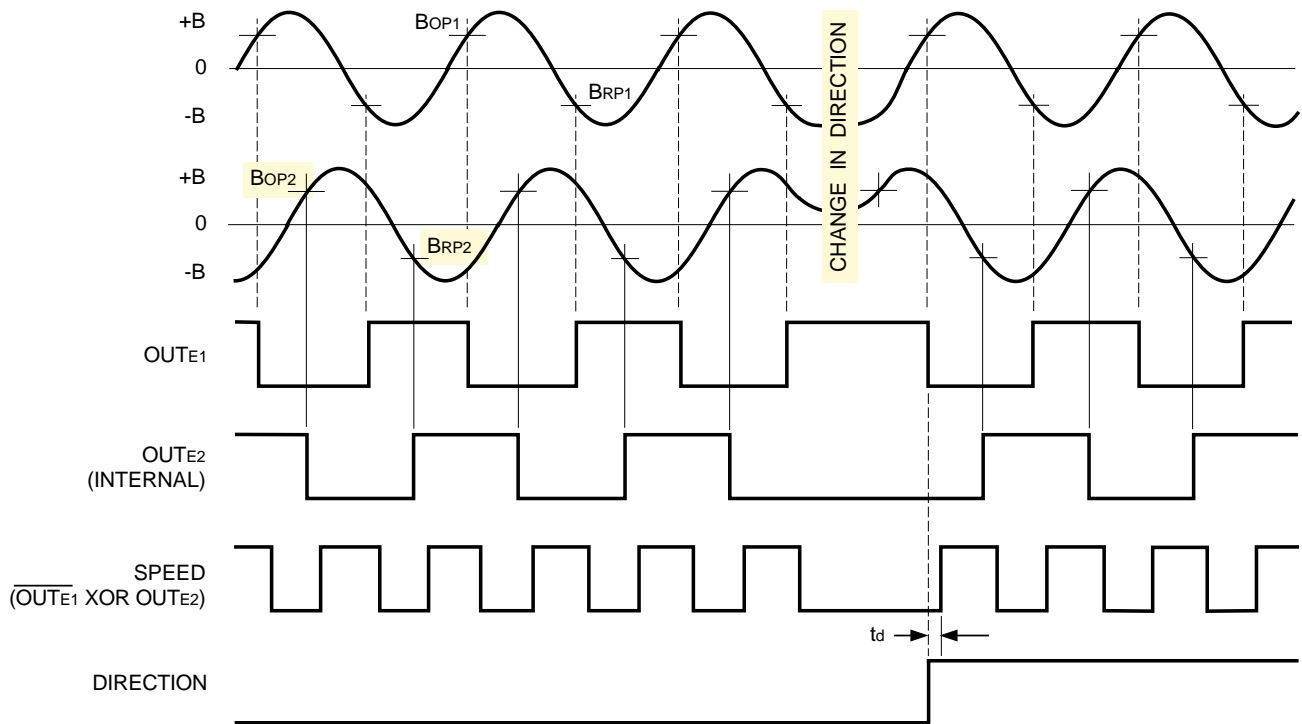

3421 AND 3422 HALL-EFFECT, DIRECTION-DETECTION SENSORS

ELECTRICAL CHARACTERISTICS over operating temperature range.

Characteristic	Symbol	Test Conditions	Limits			Units
			Min.	Typ.	Max.	
Supply Voltage Range	V_{CC}	Operating, $T_J < 165^\circ\text{C}^1$	4.5	—	18	V
Output Leakage Current	I_{OFF}	$V_{OUT} = V_{CC} = 18\text{ V}$	—	<1.0	10	μA
Output Saturation Voltage	$V_{OUT(SAT)}$	$I_{OUT} = 20\text{ mA}$	—	0.21	0.50	V
Power-On State	POS	$V_{CC} = 0 \rightarrow 5\text{ V}$, $B_{RP1} < B < B_{OP1}$, $B_{RP2} < B < B_{OP2}$	OFF	OFF	OFF	—
Under-Voltage Lockout	$V_{CC(UV)}$	$I_{OUT} = 20\text{ mA}$, $V_{CC} = 0 \rightarrow 5\text{ V}$	—	3.5	—	V
Under-Voltage Hysteresis	$V_{CC(hys)}$	Lockout ($V_{CC(UV)}$) - Shutdown	—	0.5	—	V
Power-On Time	t_{po}	$V_{CC} > 4.5\text{ V}$	—	—	50	μs
Output Rise Time	t_r	$C_L = 20\text{ pF}$, $R_L = 820\ \Omega$	—	200	—	ns
Output Fall Time	t_f	$C_L = 20\text{ pF}$, $R_L = 820\ \Omega$	—	200	—	ns
Direction Change Delay	t_d	$C_L = 20\text{ pF}$, $R_L = 820\ \Omega$	0.5	1.0	5.0	μs
Supply Current	I_{CC}	$V_{CC} = 8\text{ V}$, All outputs OFF	5.0	9.0	18	mA

- NOTES: 1. Maximum supply voltage must be adjusted for power dissipation and ambient temperature.
2. Typical Data is at $V_{CC} = 12\text{ V}$ and $T_A = +25^\circ\text{C}$ and is for design information only.

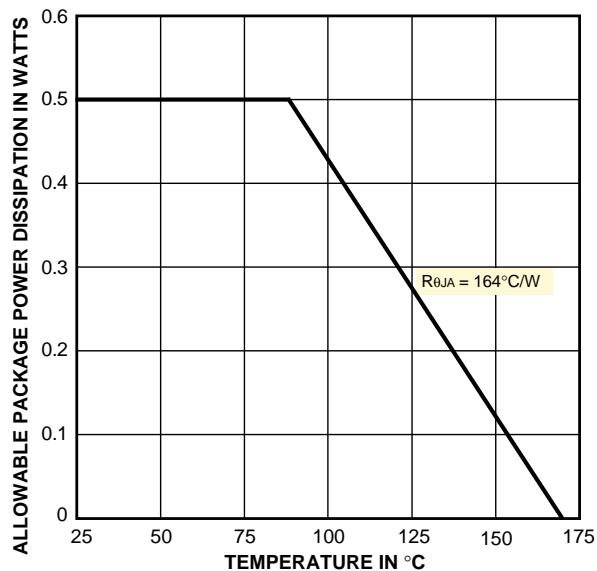

Dwg. GH-069

3421 AND 3422 HALL-EFFECT, DIRECTION-DETECTION SENSORS

MAGNETIC CHARACTERISTICS over operating voltage range.

Characteristic	Symbol	Test Conditions	A3421xKA			A3422xKA			Units
			Min.	Typ.	Max.	Min.	Typ.	Max.	
Operate Point	B _{OP}	T _A = -40°C	140	185	300	—	29	85	G
		T _A = +25°C	130	160	280	—	29	75	G
		T _A = Maximum	120	—	260	—	—	75	G
Release Point ³	B _{RP}	T _A = -40°C	-300	-190	-140	-85	-19	—	G
		T _A = +25°C	-280	-175	-130	-75	-18	—	G
		T _A = Maximum	-260	—	-120	-75	-16	—	G
Hysteresis	B _{hys}	T _A = -40°C	280	375	—	10	48	—	G
		T _A = +25°C	260	335	—	10	46	—	G
		T _A = Maximum	240	—	—	10	—	—	G
Operate Differential		B _{OP1} - B _{OP2}	—	—	±80	—	—	±60	G
Release Differential		B _{RP1} - B _{RP2}	—	—	±80	—	—	±60	G

- NOTES: 1. Magnetic flux density is measured at most sensitive area of device, nominally located 0.014" (0.37 mm) below the branded face of the package.
 2. Typical Data is at V_{CC} = 12 V and T_A = +25°C and is for design information only.
 3. As used here, negative flux densities are defined as less than zero (algebraic convention).

3421 AND 3422 HALL-EFFECT, DIRECTION-DETECTION SENSORS

TYPICAL A3421xKA CHARACTERISTICS

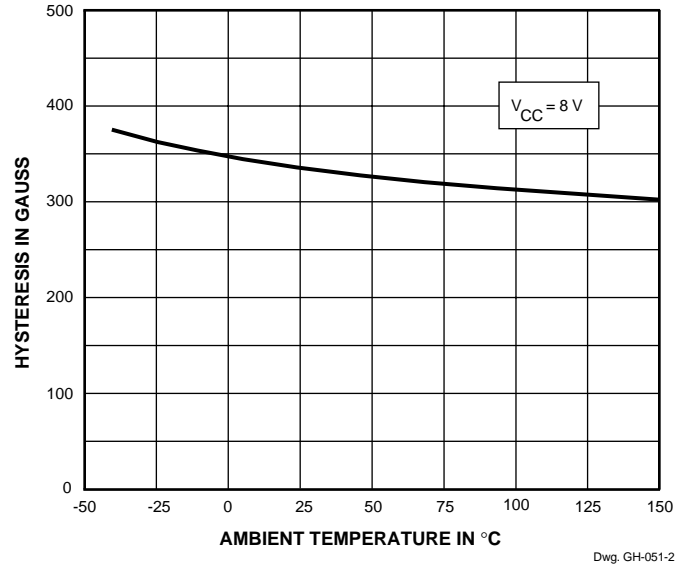
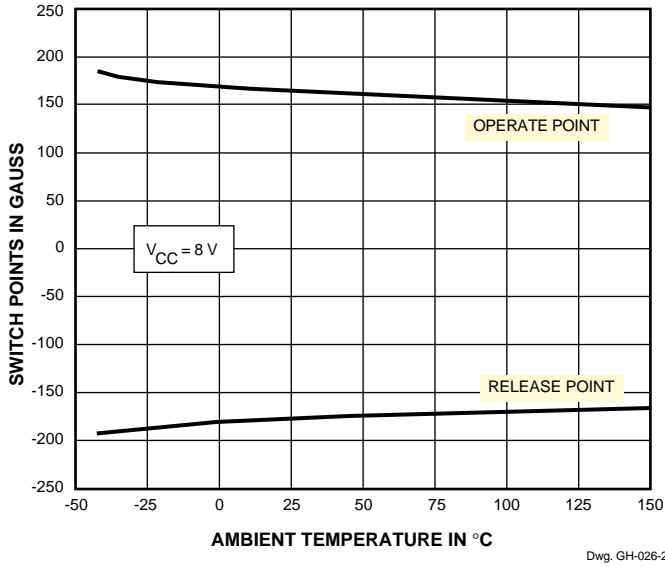

TYPICAL A3422xKA CHARACTERISTICS

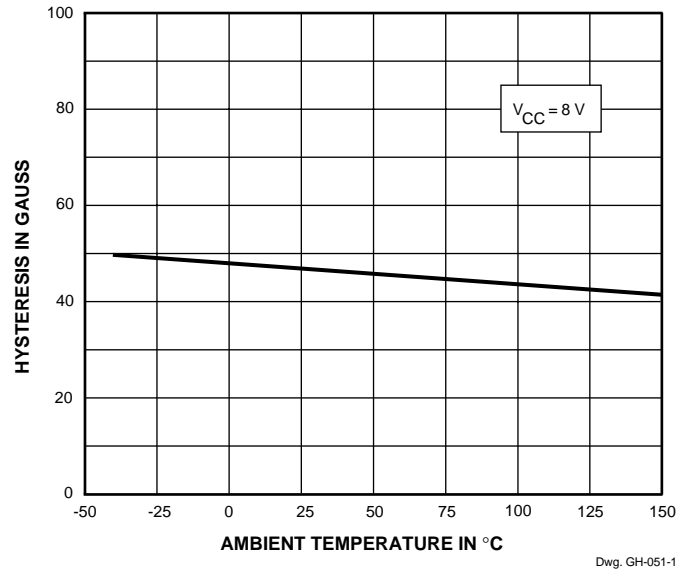
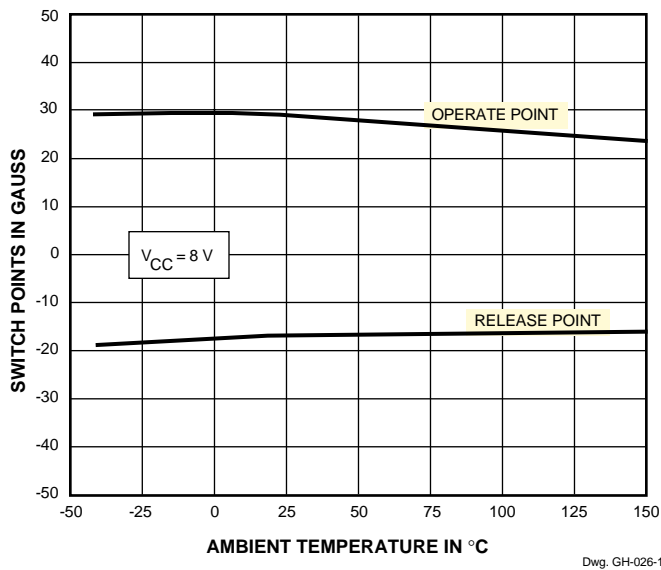

3421 AND 3422 HALL-EFFECT, DIRECTION-DETECTION SENSORS

TYPICAL ELECTRICAL CHARACTERISTICS

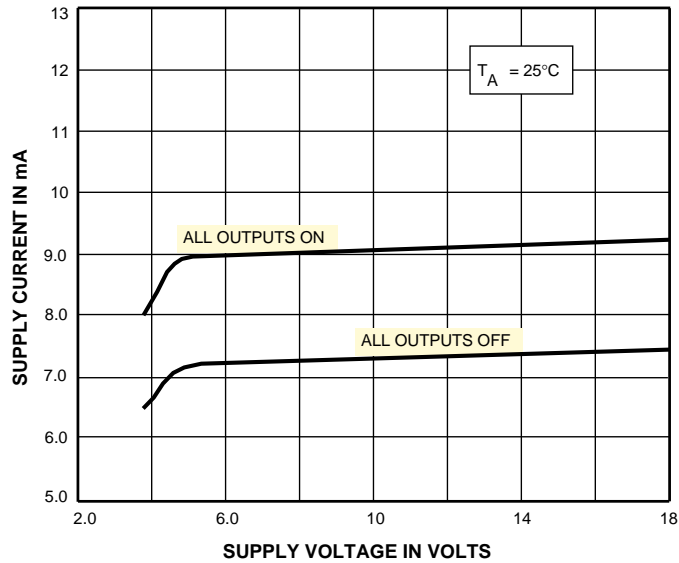
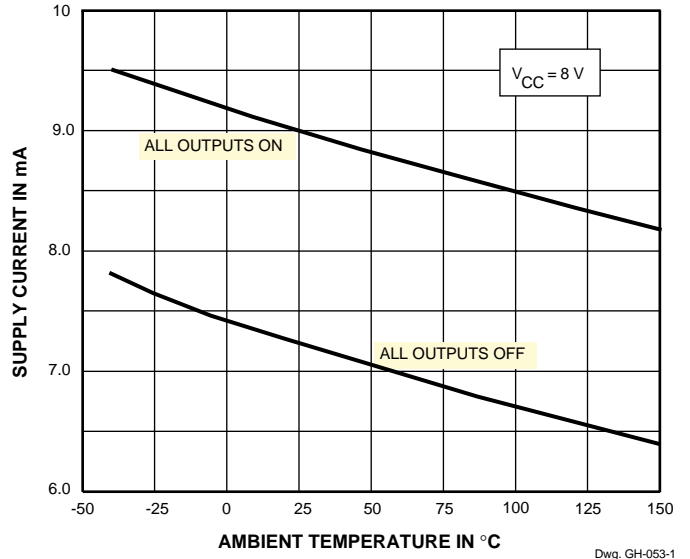
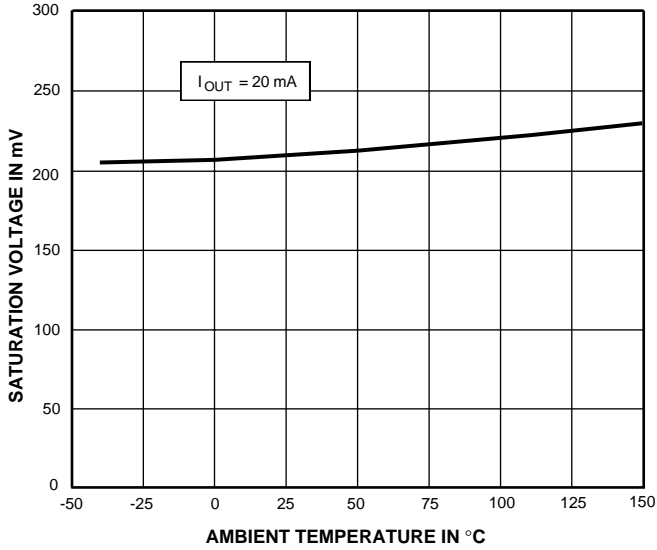

3421 AND 3422 HALL-EFFECT, DIRECTION-DETECTION SENSORS

FUNCTIONAL DESCRIPTION

The integrated circuit contains an internal voltage regulator that powers the Hall sensors and both the analog and digital circuitry. This regulator allows operation over a wide supply voltage range and provides some immunity to supply noise. The device also contains CMOS logic circuitry that decodes the direction of rotation of the ring magnet.

Quadrature/Direction Detection. Internal logic circuitry provides outputs representing speed and direction of the magnetic field across the face of the package. For the direction signal to be appropriately updated, a quadrature relationship must be maintained between the ring magnet pole width, the sensor-to-sensor spacing, and, to a lesser extent, the magnetic switch points. For optimal design, the sensor should be actuated with a ring magnet pole width two times the sensor-to-sensor spacing. This will produce a sinusoidal magnetic field whose period (denoted as T) is then four times the sensor-to-sensor spacing. A quadrature relationship can also be maintained for a ring magnet that has a period that satisfies the relationship $nT/4 = 1.5$ mm, where n is any odd integer. Therefore, ring magnets with pole-pair spacings equal to 6 mm ($n = 1$), 2 mm ($n = 3$), 1.2 mm ($n = 5$), etc. are permitted.

The response of the device to the magnetic field produced by a rotating ring magnet is shown on page 2. Note the phase shift between the two integrated sensors.

Outputs. The device provides three saturated outputs: DIRECTION, E1 OUTPUT, and SPEED. DIRECTION provides the direction output of the sensor and is defined as OFF (high) for the direction E2 to E1 (South pole to the package face) and ON (low) for the direction E1 to E2 (South pole to the package face). SPEED provides an XOR'd output of the two sensors. Because of internal delays, DIRECTION will always be updated before SPEED and is updated at every transition of E1 OUTPUT and E2 OUTPUT (internal) allowing the use of up-down counters without the loss of pulses.

Power-On State. At power on, the logic circuitry is reset to provide an OFF (high) at DIRECTION and an OFF (high) for E1 and E2 (internal) for magnetic fields less than B_{OP} . This eliminates ambiguity when the device is powered up and either sensor detects a field between B_{OP} and B_{RP} . If either sensor is subjected to a field greater than B_{OP} , the internal logic will set accordingly.

3421 AND 3422 HALL-EFFECT, DIRECTION-DETECTION SENSORS

APPLICATIONS INFORMATION

Operation with Fine-Pitch Ring Magnets. For targets with a circular pitch of less than 4mm, a performance improvement can be observed by rotating the front face of the sensor subassembly (see below). This sensor rotation decreases the effective sensor-to-sensor spacing, provided that the Hall elements are not rotated beyond the width of the target.

Applications. It is strongly recommended that an external 0.01 μ F bypass capacitor be connected (in close proximity to the Hall sensor) between the supply and ground of the device to reduce both external noise and noise generated by the internal logic.

The simplest form of magnet that will operate these devices is a ring magnet. Other methods of operation, such as linear magnets, are possible. Extensive applications information on magnets and Hall-effect sensors is also available in the *Allegro Electronic Data Book AMS-702* or *Application Note 27701*.

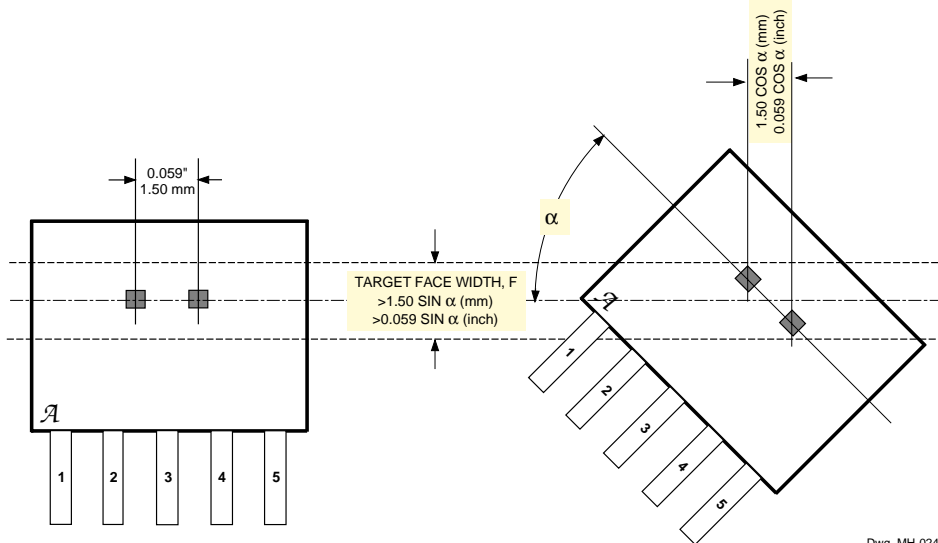

3421 AND 3422 HALL-EFFECT, DIRECTION-DETECTION SENSORS

CRITERIA FOR DEVICE QUALIFICATION

All Allegro sensors are subjected to stringent qualification requirements prior to being released to production. To become qualified, except for the destructive ESD tests, no failures are permitted.

Qualification Test	Test Method and Test Conditions	Test Length	Samples Per Lot	Comments
Temperature Humidity Bias Life	JESD22-A101, T _A = 85°C, RH = 85%	1000 hrs	77	Device biased for minimum power
Bias Life (Surge Operating Life)	JESD22-A108, T _A = 150°C, T _J = 165°C	1000 hrs	77	
	JESD22-A108, T _A = 175°C, T _J = 190°C	1000 hrs	77	
Autoclave, Unbiased	JESD22-A102, T _A = 121°C, 15 psig	96 hrs	77	
High-Temperature (Bake) Storage Life	JESD22-A103, T _A = 170°C	1000 hrs	77	
Temperature Cycle	JESD22-A104	1000 cycles	77	-55°C to +150°C
ESD, Human Body Model	CDF-AEC-Q100-002	Pre/Post Reading	3 per test	Test to failure All leads > 8 kV

SENSOR LOCATIONS

(±0.005" [0.13 mm] die placement)

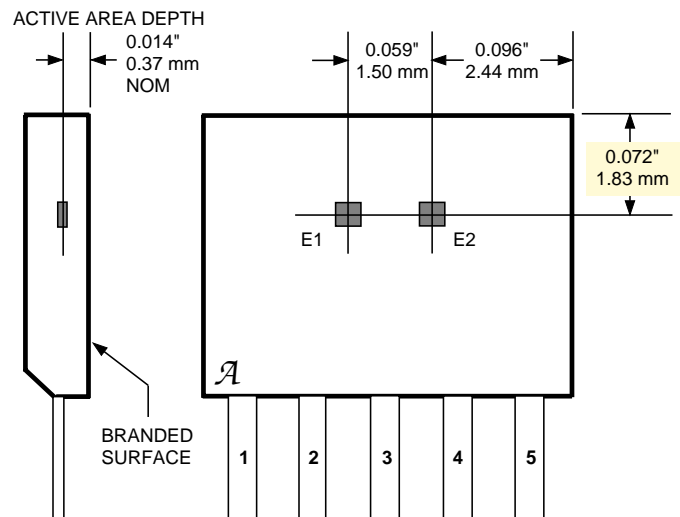

3421 AND 3422 HALL-EFFECT, DIRECTION-DETECTION SENSORS

PACKAGE DESIGNATOR 'KA'

Dimensions in Inches (controlling dimensions)

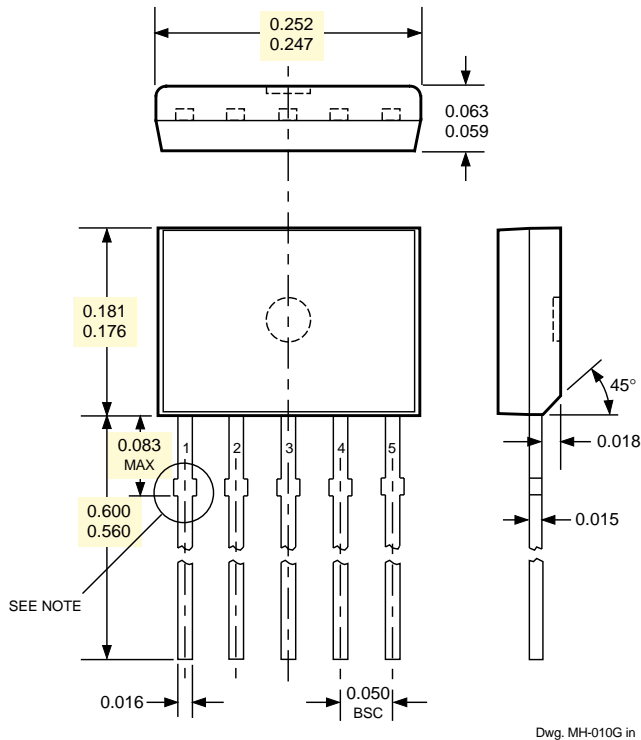

Dimensions in Millimeters (for reference only)

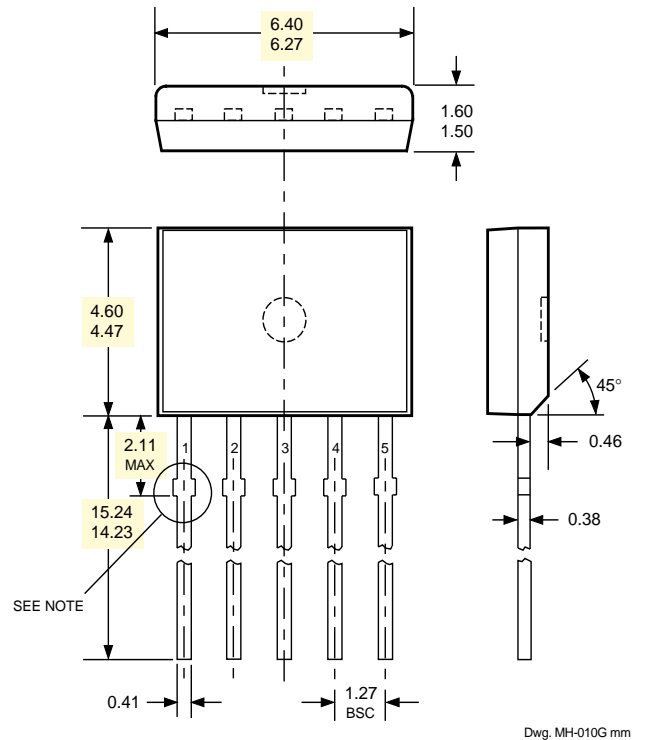

SURFACE-MOUNT LEAD FORM (Suffix '-TL')

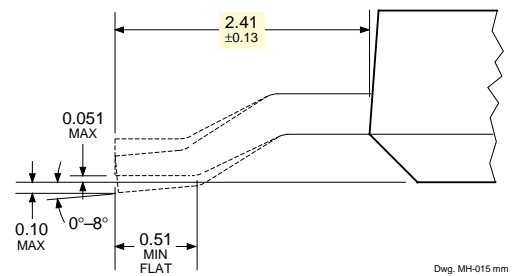
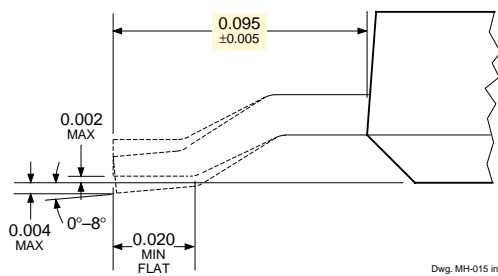

- NOTES:
1. Tolerances on package height and width represent allowable mold offsets. Dimensions given are measured at the widest point (parting line).
 2. Exact body and lead configuration at vendor's option within limits shown.
 3. Height does not include mold gate flash.
 4. Recommended minimum PWB hole diameter to clear transition area is 0.035" (0.89 mm).
 5. Where no tolerance is specified, dimension is nominal.

**3421 AND 3422
HALL-EFFECT,
DIRECTION-DETECTION
SENSORS**

HALL-EFFECT SENSORS SELECTION GUIDE

Partial Part Number	Avail. Oper. Temp.	Operate Limits Over Temp.			Function†	Notes
		BOP max	BRP min	B _{hys} min		
3046	E/L	+200	-200	15	Gear-Tooth Sensor	
3054	K/S	+300	+5	5.0	Unipolar Multiplex	1
3056	E/L	+225	-225	15	Gear-Tooth Sensor	
3058	E/L	+300	-300	150	Gear-Tooth Sensor	
3059	K/S	+100	-100	20	AC Gear-Tooth Sensor	
3060	K/S	+35	-35	10	AC Gear-Tooth Sensor	
3121	E/L	+500	+80	60	Unipolar Switch	
3122	E/L	+430	+120	70	Unipolar Switch	
3123	E/L	+470	+160	70	Unipolar Switch	
3132	K/L/S	+95	-95	30	Bipolar Switch	
3133	K/L/S	+75	-75	30	Bipolar Switch	
3134	E/L	+50	-50	5.0	Bipolar Switch	
3141	E/L	+175	+10	20	Unipolar Switch	
3142	E/L	+245	+60	30	Unipolar Switch	
3143	E/L	+355	+150	30	Unipolar Switch	
3144	E/L	+450	+25	20	Unipolar Switch	
3161	E	+160	+30	5.0	2-Wire Unipolar Switch	
3175	S	+180	-180	80	Latch	
3177	S	+150	-150	50	Latch	
3185	E/K/L/S	+300	-300	280	Latch	
3187	E/K/L/S	+175	-175	100	Latch	
3188	E/K/L/S	+200	-200	160	Latch	
3189	E/K/L/S	+250	-250	100	Latch	
3195	E/L	+200	-200	110	Latch	2, 3
3197	L	+200	-200	110	Latch	3
3210	E	±70	±5	7.7*	Chopper-Stabilized Switch	
3235	S	+200	+15	15	Unipolar Switch	4
		-15	-200	15	Unipolar Switch	
3275	S	+250	-250	100	Latch	5
3421	E/L	+300	-300	240	Direction Detection	
3422	E/L	+85	-85	10	Direction Detection	
3503	S	Typ. 1.3 mV/G	—	—	Linear Sensor	
3515	E/L	Typ. 5.0 mV/G	—	—	Chopper-Stabilized Linear Sensor	
3516	E/L	Typ. 2.5 mV/G	—	—	Chopper-Stabilized Linear Sensor	
3517	L/S	Typ. 5.0 mV/G	—	—	Chopper-Stabilized Linear Sensor	
3518	L/S	Typ. 2.5 mV/G	—	—	Chopper-Stabilized Linear Sensor	
3625	S	+150	-150	200*	900 mA Latch	3, 5, 6
3626	S	+150	-150	200*	400 mA Latch	3, 5, 6
5140	E	+240	+25	20	300 mA Unipolar Switch	3, 6

Operating Temperature Ranges:

C = 0°C to +70°C, S = -20°C to +85°C, E = -40°C to +85°C, K = -40°C to +125°C, L = -40°C to +150°C

Notes 1. Multiplexed two-wire sensor; after proper address, power/signal bus current indicates magnetic field condition.

2. Active pull down.

3. Protected.

4. Output 1 switches on south pole, output 2 switches on north pole for 2-phase, bifilar-wound, unipolar-driven brushless dc motor control.

5. Complementary outputs for 2-phase bifilar-wound, unipolar-driven brushless dc motor control.

6. Power driver output.

* Typical.

† Latches will not switch on removal of magnetic field; bipolar switches may switch on removal of field but require field reversal for reliable operation over operating temperature range.

**3421 AND 3422
HALL-EFFECT,
DIRECTION-DETECTION
SENSORS**

Allegro MicroSystems, Inc. reserves the right to make, from time to time, such departures from the detail specifications as may be required to permit improvements in the design of its products.

The information included herein is believed to be accurate and reliable. However, Allegro MicroSystems, Inc. assumes no responsibility for its use; nor for any infringements of patents or other rights of third parties which may result from its use.



115 Northeast Cutoff, Box 15036
Worcester, Massachusetts 01615-0036 (508) 853-5000