

OMR7905SR OMR7905ST OMR7905NM OMR7905NH
 OMR7912SR OMR7912ST OMR7912NM OMR7912NH
 OMR7915SR OMR7915ST OMR7915NM OMR7915NH

300 kRAD RADIATION TOLERANT 1.5 AMP NEGATIVE FIXED VOLTAGE REGULATORS

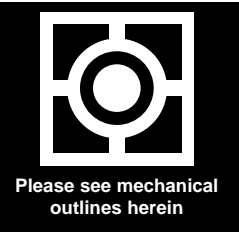

**300K Rad Tolerant Three Terminal,
 Negative Fixed Voltage Regulators
 In Hermetic Packages**

FEATURES

- Isolated & Non-Isolated Hermetic Packages
- Output Voltages: -5V, -12V, -15V (Other Voltages Available)
- Output Voltages Set Internally To $\pm 1\%$ or $\pm 2\%$
- Built-In Thermal Overload Protection
- Short Circuit Current Limiting
- Radiation Tolerant up to 450 K Rad (Si)
- Available Hi-Rel Screened, Class B and Class S, MIL-STD-883

DESCRIPTION

These three terminal negative regulators are supplied in a high density hermetically sealed metal package and are available hi-rel screened. All protective features are designed into the circuit, including thermal shutdown, current limiting and safe-area control. With heat sinking, they can deliver over 1.5 amps of output current. These units feature internally trimmed output voltages to $\pm 1\%$ or 2% of nominal voltage. Standard voltages are -5V, -12V, and -15V. However, other voltages are available up to -24 volts. These devices are ideally suited for Space applications where small size, high reliability, and radiation tolerance is required. The high level of Radiation Tolerance of these devices makes them a desirable choice for LEO and many MEO and GEO communication satellites. Radiation testing is performed on a single wafer by wafer basis. Random die samples per wafer are selected, packaged and radiation tested to qualify each individual semiconductor wafer-by-wafer.

ABSOLUTE MAXIMUM RATINGS @ 25°C

Input Voltage	-35 V
Operating Junction Temperature Range.....	- 55°C to + 150°C
Storage Temperature Range.....	- 65°C to + 150°C
Power Dissipation: TO-205	1.1 W
TO-257/SMD/ D ² Pac	20 W
Lead Temperature (Soldering 10 seconds)	300°C
Surface Mount Package Soldering Temperature	250°C
Thermal Resistance, Junction to Case:	
TO-205	17°C/W
TO-257(Isolated), D ² Pac (Isolated)	4.2°C/W
SMD-1	3.5°C/W
Thermal Resistance, (Junction Ambient):	
TO-205	90°C/W
TO-257(Isolated), D ² Pac (Isolated) SMD-1	42°C/W
Maximum Output Current: TO-205.....	0.5 A
Case-All Others.....	3.3A
Radiation Tolerant - Total Dose	300 K Rad (Si)

OMR7905SR
OMR7912SR
OMR7915SR

OMR7905ST
OMR7912ST
OMR7915ST

OMR7905NM
OMR7912NM
OMR7915NM

OMR7905NH
OMR7912NH
OMR7915NH

ELECTRICAL CHARACTERISTICS -5 Volt $V_{IN} = -10V, I_O = 500mA, -55^{\circ}C \leq T_A \leq 125^{\circ}C$ (unless otherwise specified)

Parameter	Symbol	Test Conditions	Min.	Max.	Unit
Output Voltage	V_{OUT}	$T_A = 25^{\circ}C$	-4.95	-5.05	V
		$V_{IN} = -7.5V$ to $-20V$	• -4.85	-5.15	V
Line Regulation (Note 1)	V_{RLINE}	$V_{IN} = -7.5V$ to $-20V$		12	mV
			•	25	mV
		$V_{IN} = -8.0V$ to $-12V$		5	mV
Load Regulation (Note 1)	V_{RLOAD}	$I_O = 5mA$ to 1.5 Amp		20	mV
			•	25	mV
		$I_O = 250mA$ to 750 mA		15	mV
Standby Current Drain	I_{SCD}			2.5	mA
			•	3.0	mA
Standby Current Drain Change With Line	ΔI_{SCD} (Line)	$V_{IN} = -7.0V$ to $-20V$	•	0.4	mA
Standby Current Drain Change With Load	ΔI_{SCD} (Load)	$I_O = 5mA$ to 1000mA	•	0.4	mA
Dropout Voltage	V_{DO}	$\Delta V_{OUT} = 100mV, I_O = 1.0A$	•	2.5	V
Peak Output Current	$I_{O(pk)}$	$T_A = 25^{\circ}C$	1.5	3.3	A
Short Circuit Current (Note 2)	I_{DS}	$V_{IN} = -35V$		1.2	A
			•	2.8	A
Ripple Rejection	$\frac{\Delta V_{IN}}{\Delta V_{OUT}}$	$f = 120 Hz, \Delta V_{IN} = -10V$	63		dB
		(Note 3)	• 60		dB
Output Noise Voltage (Note 3)	N_O	$T_A = 25^{\circ}C, f = 10 Hz$ to 100KHz		40	$\mu V/V$ RMS
Long Term Stability (Note 3)	$\frac{\Delta V_{OUT}}{\Delta t}$	$T_A = 25^{\circ}C, t = 1000 hrs.$		75	mV

ELECTRICAL CHARACTERISTICS -12 Volt $V_{IN} = -19V, I_O = 500mA, -55^{\circ}C \leq T_A \leq 125^{\circ}C$ (unless otherwise specified)

Parameter	Symbol	Test Conditions	Min.	Max.	Unit
Output Voltage	V_{OUT}	$T_A = 25^{\circ}C$	-11.88	-12.12	V
		$V_{IN} = -14.5V$ to $-27V$	• -11.64	-12.36	V
Line Regulation (Note 1)	V_{RLINE}	$V_{IN} = -14.5V$ to $-27V$		20	mV
			•	50	mV
		$V_{IN} = -16V$ to $-22V$		10	mV
Load Regulation (Note 1)	V_{RLOAD}	$I_O = 5mA$ to 1.5 Amp		32	mV
			•	60	mV
		$I_O = 250mA$ to 750 mA		16	mV
Standby Current Drain	I_{SCD}			3.5	mA
			•	4.0	mA
Standby Current Drain Change With Line	ΔI_{SCD} (Line)	$V_{IN} = -14.5V$ to $-27V$	•	0.8	mA
Standby Current Drain Change With Load	ΔI_{SCD} (Load)	$I_O = 5mA$ to 1000mA	•	0.5	mA
Dropout Voltage	V_{DO}	$\Delta V_{OUT} = 100mV, I_O = 1.0A$	•	1.8	V
Peak Output Current	$I_{O(pk)}$	$T_A = 25^{\circ}C, I_O = 5mA$ to 1A	1.5	3.3	A
Short Circuit Current (Note 2)	I_{DS}	$V_{IN} = -35V$		1.2	A
			•	2.8	A
Ripple Rejection	$\frac{\Delta V_{IN}}{\Delta V_{OUT}}$	$f = 120 Hz, \Delta V_{IN} = -10V$	56		dB
		(Note 3)	• 53		dB
Output Noise Voltage (Note 3)	N_O	$T_A = 25^{\circ}C, f = 10 Hz$ to 100KHz		40	$\mu V/V$ RMS
Long Term Stability (Note 3)	$\frac{\Delta V_{OUT}}{\Delta t}$	$T_A = 25^{\circ}C, t = 1000 hrs.$		120	mV

Notes:

1. Load and Line Regulation are specified at a constant junction temperature. Pulse testing with low duty cycle is used. Changes in output voltage due to heating effects must be taken into account separately.
2. Short Circuit protection is only assured up to $V_{IN} = -35V$.
3. If not tested, shall be guaranteed to the specified limits.
4. The • denotes the specifications which apply over the full operating temperature range.
5. Refer to curves for typical characteristics versus Total Dose Radiation Levels.

OMR7905SR
OMR7912SR
OMR7915SR

OMR7905ST
OMR7912ST
OMR7915ST

OMR7905NM
OMR7912NM
OMR7915NM

OMR7905NH
OMR7912NH
OMR7915NH

OMNIREL'S RADIATION TEST PROCEDURE

- Radiation Testing is performed on a single wafer by wafer basis.
- Each wafer is identified and a random sample of 5 die per wafer is selected.
- The die are then individually assembled in a hermetic package, data logged, electrically tested, hi-rel screened and then submitted to radiation testing.
- The packaged die are submitted to Steady State Total Dose radiation per Method 1019, Condition A, at a dose rate of 50 RAD/sec biased at maximum supply voltage.
- Final electrical test is performed within two hours of both Total Dose Radiation level from a Cobalt 60 source and 168 hr, 100°C annealing process. Read and record data including two non-radiated control samples.
- The wafer is then qualified only if samples from wafers meet full electrical specifications after 150% of total dose rating as specified in each product data sheet.
- Omnirel's controlling specifications are as follows: For Voltage Regulators the controlling specification is MIL-PRF- 38534/MIL-STD-883. For Rectifiers/Schottky the controlling specification is MIL-PRF-19500/MIL-STD-750.

AVAILABLE PRODUCT SCREENING

Standard Class Level Screening Per MIL-PRF-38535				
Screen	*Level B		*Level S	
	Test Method	Required	Test Method	Required
Wafer Lot Acceptance	-----	-----	5007	100%
Non-destructive Bond Pull	-----	-----	-----	-----
Pre-Cap Visual Inspection	2010	100%	2010	100%
Temperature Cycle	1010	100%	1010	100%
Constant Acceleration	2001	100%	2001	100%
Visual Inspection	-----	100%	-----	100%
PIND Test	-----	-----	2020	100%
Serialization	-----	-----	-----	100%
Pre-Burn-In Electrical	Data Sheet	100%	Data Sheet	100%
Burn-In	1015/160 hrs.	100%	1015/240hrs.	100%
Interim Electrical	-----	-----	Data Sheet	100%
PDA Calculations	5% Functional	Lot	5% Functional	Lot
Final Electrical	Data Sheet	100%	Data Sheet	100%
Fine & Gross Seal	1014	100%	1014	100%
Radiographic	-----	-----	2012/Two Views	100%
Conformance Inspection**	GR A	100%	GR A	100%
Final Visual Inspection	2009	Sample	2009	Sample

* For "B" Level Screening add "M" to part number, for "S" Level Screening add "S" to part number. See Part Number Designator.

** Additional conformance inspection testing, i.e. Group B, C, & D, optional.



OMR7905SR
OMR7912SR
OMR7915SR

OMR7905ST
OMR7912ST
OMR7915ST

OMR7905NM
OMR7912NM
OMR7915NM

OMR7905NH
OMR7912NH
OMR7915NH

TYPICAL RADIATION CURVES

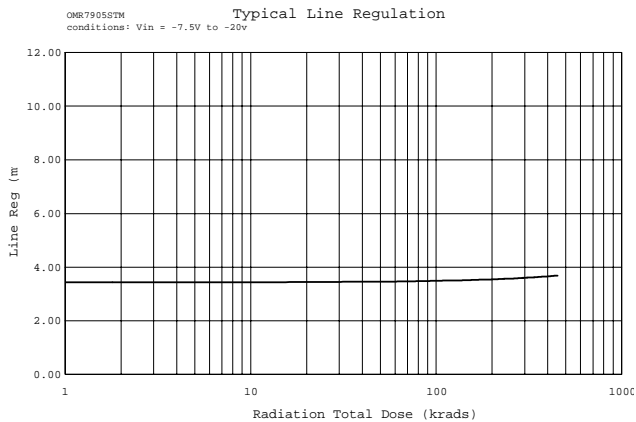
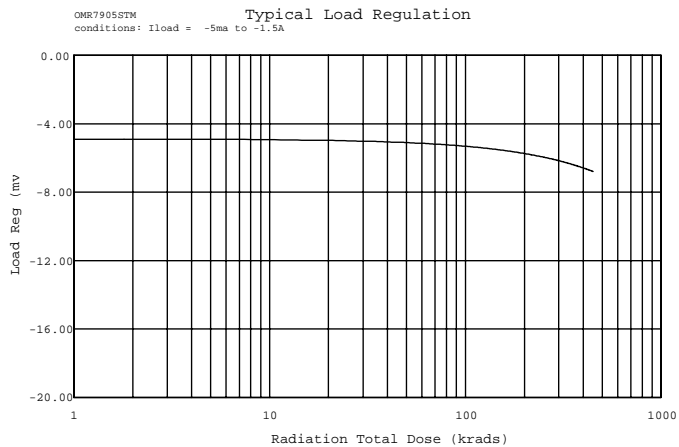
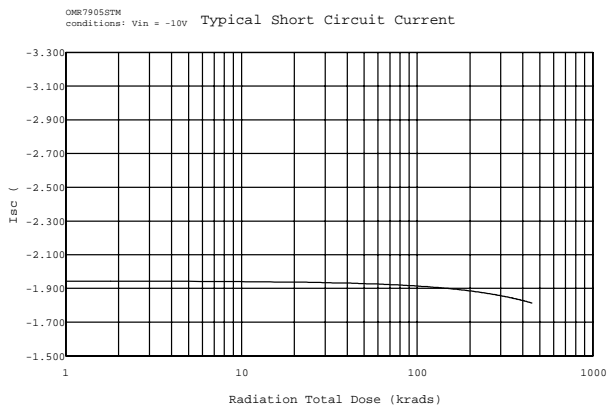
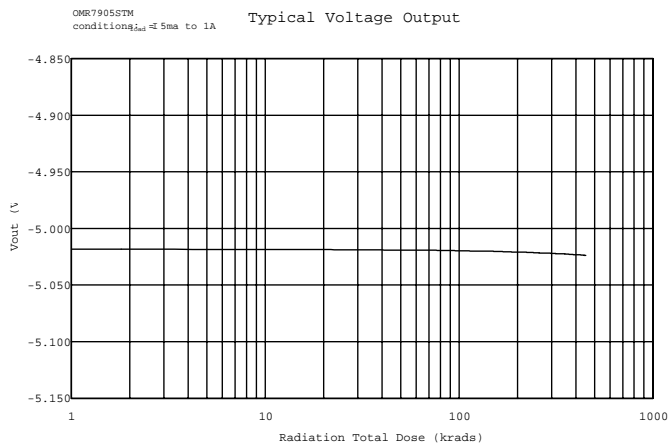

OMR7905SR
OMR7912SR
OMR7915SR

OMR7905ST
OMR7912ST
OMR7915ST

OMR7905NM
OMR7912NM
OMR7915NM

OMR7905NH
OMR7912NH
OMR7915NH

TYPICAL RADIATION CURVES

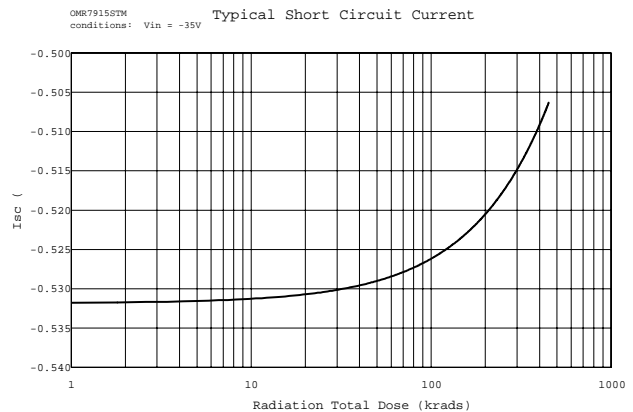
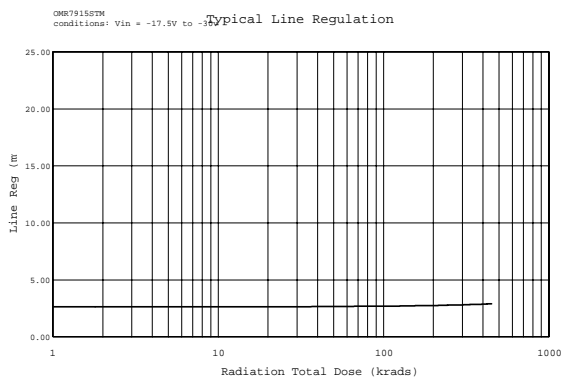
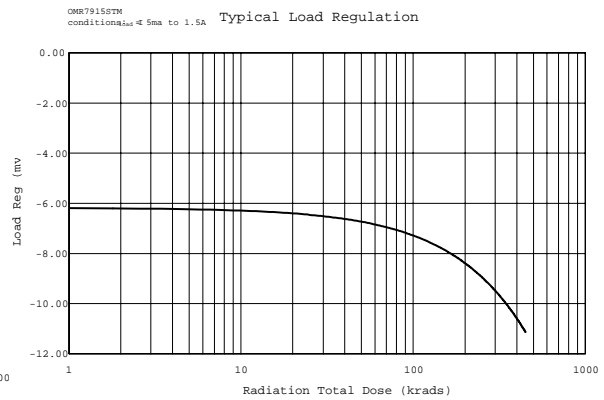
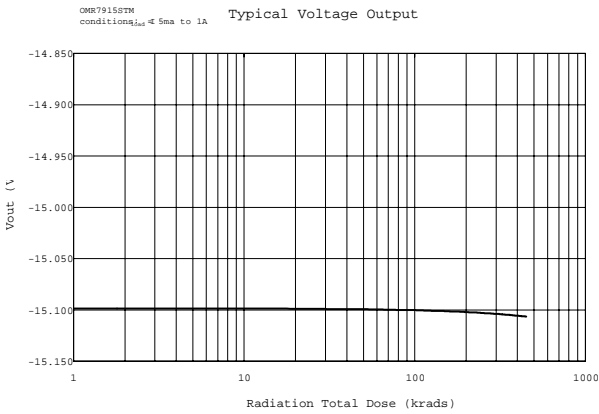
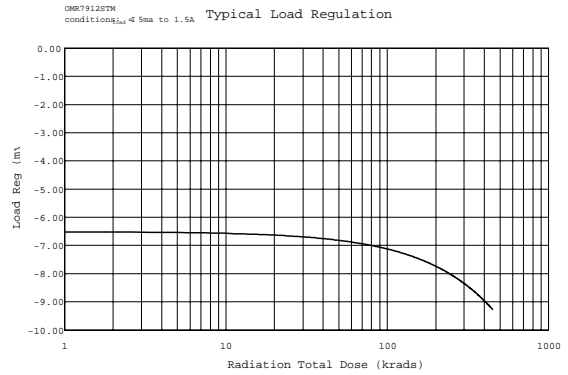
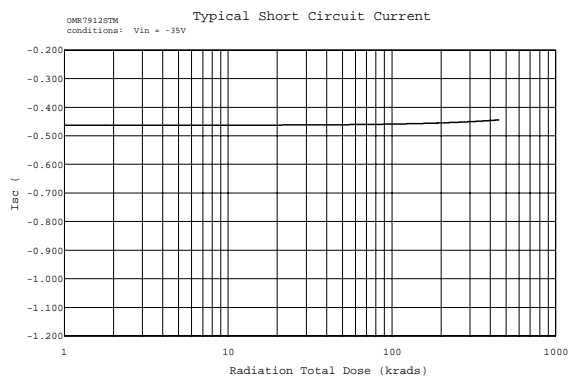
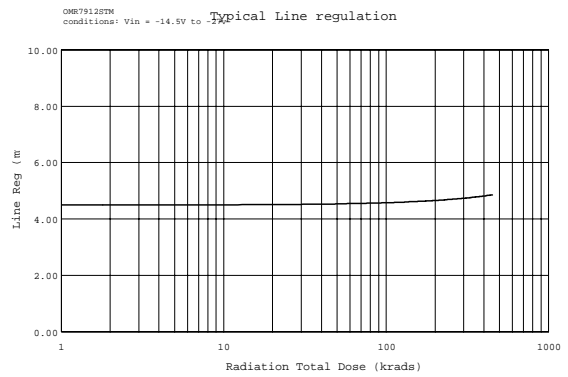
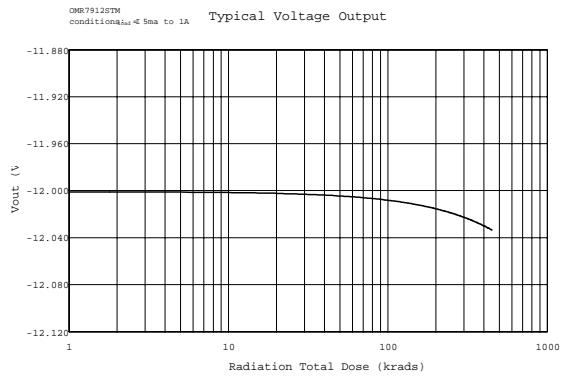

OMR7905SR
OMR7912SR
OMR7915SR

OMR7905ST
OMR7912ST
OMR7915ST

OMR7905NM
OMR7912NM
OMR7915NM

OMR7905NH
OMR7912NH
OMR7915NH

TYPICAL PERFORMANCE CHARACTERISTICS

PEAK OUTPUT CURRENT

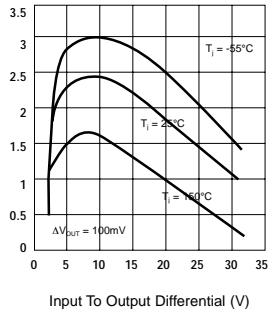

DROPOUT VOLTAGE

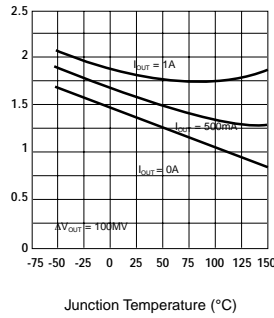

RIPPLE REJECTION

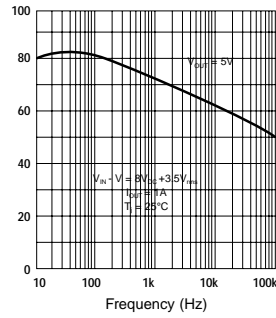

TYPICAL APPLICATIONS

Input bypass capacitors are recommended for stable operation of the OM7900 series of regulators over the input voltage and output current ranges. Output bypass capacitors will improve the transient response of the regulator.

The bypass capacitors, (2.2μF on the input, 1μF on the output) should be ceramic or solid tantalum which have good high frequency characteristics. If aluminum electrolytics are used, their values should be 10μF or larger. The bypass capacitors should be mounted with the shortest leads, and if possible, directly across the regulator terminals.

Basic Current Regulator

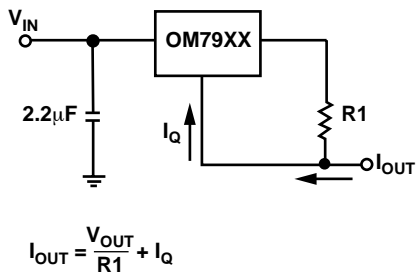

Fixed Output Regulator

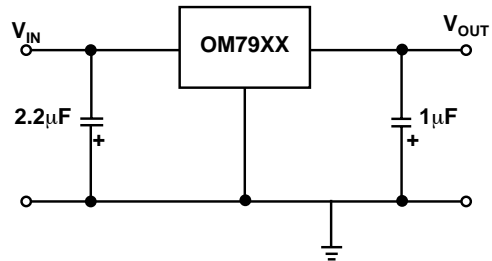

OMR7905SR
OMR7912SR
OMR7915SR

OMR7905ST
OMR7912ST
OMR7915ST

OMR7905NM
OMR7912NM
OMR7915NM

OMR7905NH
OMR7912NH
OMR7915NH

MECHANICAL OUTLINES

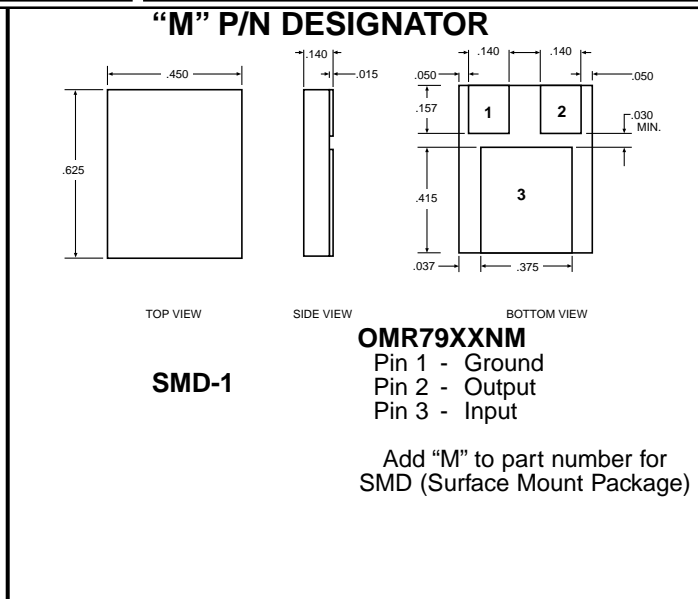
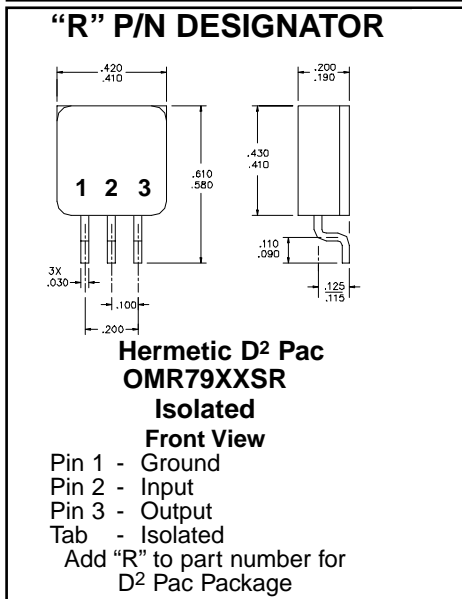
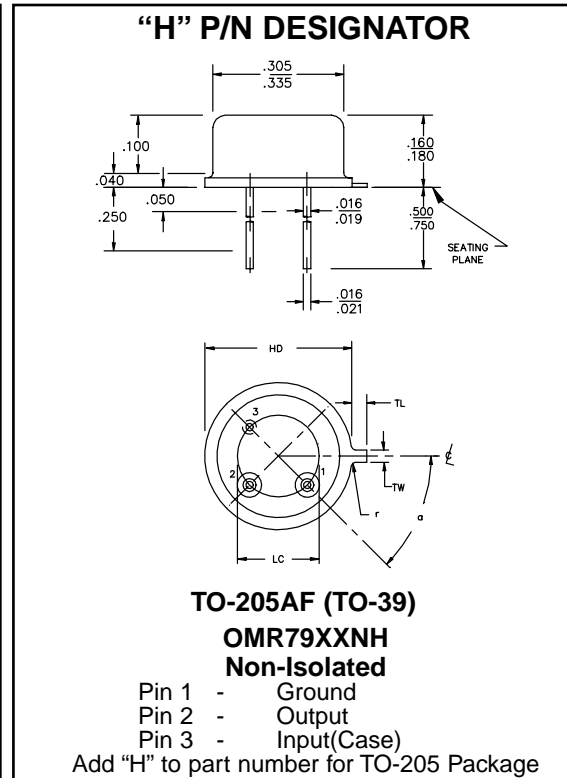
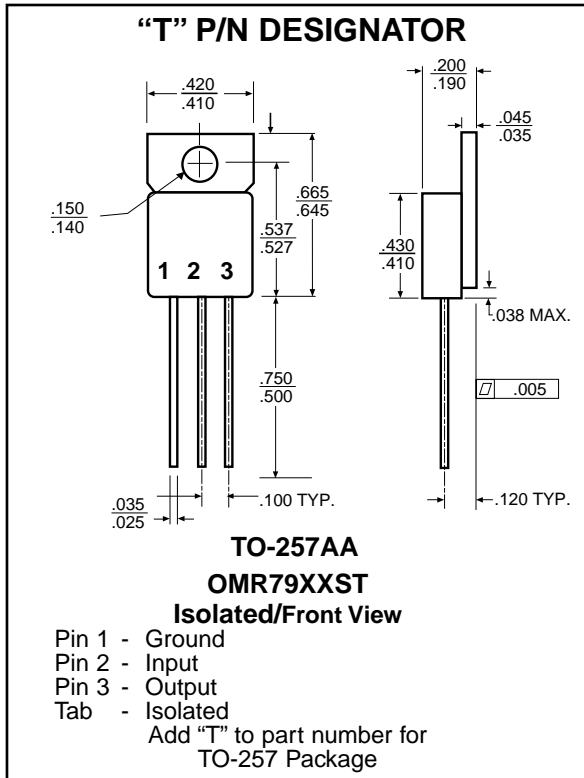

PART NUMBER DESIGNATOR (Example OMR7905STM)

