

General Description

The EVDD408/EVDD409/EVDI409/EVDN409/EVDD414 evaluation boards are general-purpose circuit boards designed to simplify the evaluation of the IXYS IXDD408, IXDD409, IXDI409, IXDN409 and IXDD414 gate drive ICs, as well as to provide a building block for power circuit development. Any of the four gate driver package types (SO-8, Dip 8, 5pin TO-220 and the 5pin TO-263) may be installed in the driver (the 5-Pin TO-263 is factory installed). The board enables the user to drive MOSFETs or IGBTs in the TO-220, TO-247, TO-264 or SOT-227 packages. The evaluation board design allows these MOSFETs to be attached to a heat sink, and in so doing the board assembly can be used as a ground referenced, low side power switch for both single-ended and push-pull configurations. The board layout for the gate driver in the TO-220 and the TO-263 packages (designator U1B), allows the ground tab to be soldered to the ground plane for cooling in high-power, high frequency applications with large MOSFET devices. Circuitry for the Tri-State function is also included on the evaluation board.

Figure 1 is a photograph of the Evaluation Board loaded with an IXDD408YI TO-263 driver and a SOT-227 MOSFET. The low level inputs are shown on the left side of the board. Control is a TTL high true input which controls the on or off state of the power switch Q1, Q2, or Q3. Enable is a low true input, which controls the Tri-State output (IXDD408, IXDD409 and IXDD414 devices only). VCC-IN is the low voltage, (8-25V) power input, (see Figure 3 below). Figure 2 illustrates the MOSFET mounting of a TO-220, TO-247, or TO-264 device. The MOSFET is mounted on the back side of the PCB. A large through hole is provided so that the device can be attached to a heat sink. The SOT-227 (shown in the photograph) is mounted in a similar manner.

Circuit Operation

The schematic diagram for the evaluation board is shown in Figure 4. The control gate is applied to R6 then on the input pin 2 of the IC. This signal input is followed in time by the output pins 7 and 6. Pins 1 and 8 are attached to +VCC via a de-coupling network comprised of R1, C1 and R2, C2. Pins 4 and 5 are attached to the circuit ground plane. This is the preferred arrangement of the bypassing for the Vcc input power. The enable pin 3 is attached to the drain of Q4. This device is used to level translate and provide an invert function for the Tri-State mode when used with the IXDD408, IXDD409 and IXDD414 devices. (The IXDI409 and IXDN409 devices do not utilize the enable input.) The drain of Q4 is also attached to the gate of the MOSFET thru RA and DA. In the Tri-State mode the turn-off time of the power MOSFET is determined by the time constant of the input gate capacitance C_{iss} and the value of the resistor RA. See the IXDD408 and IXDD414 data sheets for additional information on this mode of operation.

The U1 output is available at pins 7 and 6. These are attached to the MOSFET via the two one-Ohm resistors R4 and R5. The values of these resistors may be changed to optimize the performance of the specific device being driven.

There are three test points on the board: Control, Gate and Drain. These allow the user to easily attach an oscilloscope probe and the associated ground to the circuit to verify performance.



Figure 1 - EVDD408/EVDD409/EVDI409/EVDN409/EVDD414 Evaluation Board SOT-227 Device Installed For Illustration Purposes Only

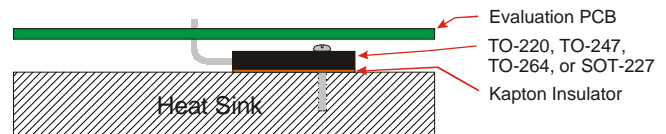

Figure 2 - Evaluation Board Side View Showing Power Device Installed In A High-Power Configuration

INPUT	FUNCTION
CONTROL	Control Input - 3V into 1K Ohms
GND1	Ground 1
ENABLE *	LOW = True, HIGH = Tri-State Mode
GND2	Ground 2
VCC-IN	VCC input - 8V to 25V
GND 3	Ground 3

* Enable function applies to IXDD408, IXDD409 and IXDD414 devices only

Figure 3 - Input Pin-Out Table

The Evaluation Boards are supplied with either IXDD408YI, IXDD409YI, IXDI409YI, IXDN409YI or IXDD414YI 5-Pin TO-263 devices installed, depending upon the evaluation board part number ordered. To use the evaluation board with a different package type, the installed device must be removed, and the new device installed in the appropriate location.

Ordering Information	
Part Number	Installed Device
EVDD408	IXDD408YI 5-Pin TO-263, 8A With Enable
EVDD409	IXDD409YI 5-Pin TO-263, 9A With Enable
EVDI409	IXDI409YI 5-Pin TO-263, 9A Inverting
EVDN409	IXDN409YI 5-Pin TO-263, 9A Non-Inverting
EVDD414	IXDD414YI 5-Pin TO-263, 14A With Enable

Figure 4 - EVDD408/EVDD409/EVDI409/EVDN409/EVDD414 Schematic Diagram

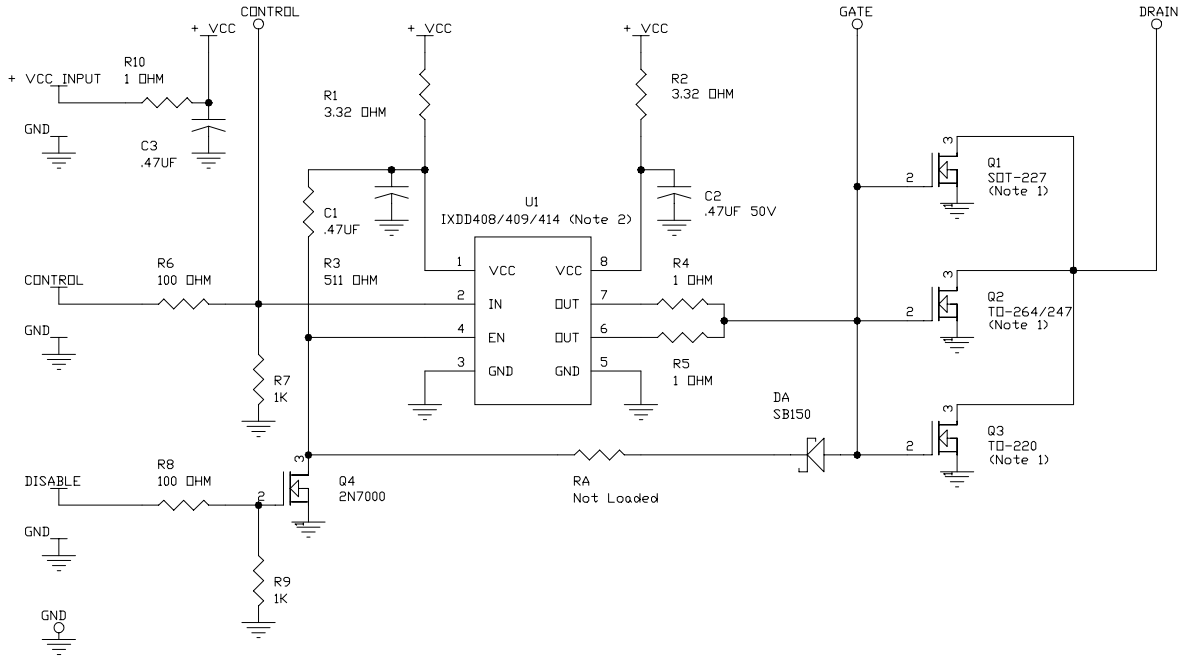

- NOTES:** 1) The schematic shows all three output switches, however only one device can be installed at any one time.
 2) The pin-out for device U1 reflects the 8-pin package types (PI and SI). See the IXDD408, IXDD/I/N409 and IXDD414 data sheet for the pin-out of the TO-220 and TO-263 (YI and CI) packages.

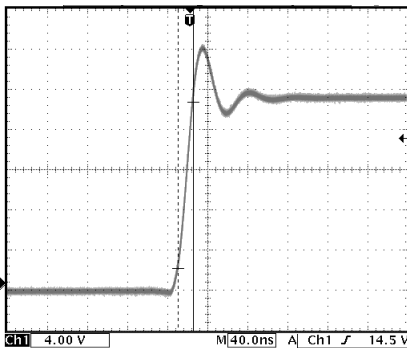

Figure 5 - IXDD408 14ns Gate Rise Time, CL=2500pF

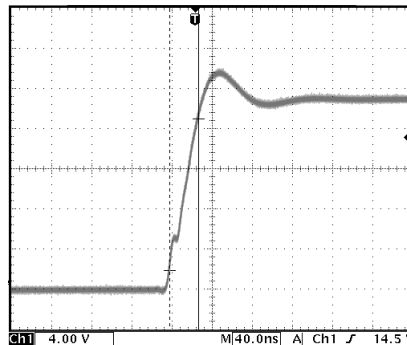

Figure 6 - IXDD408 28ns Gate Rise Time, CL=10000pF

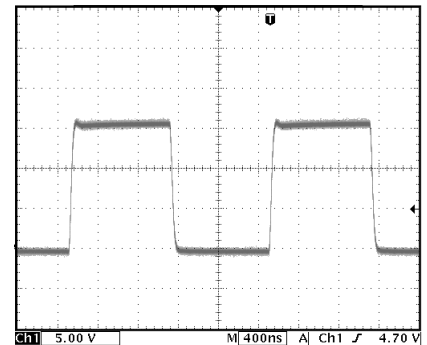

Figure 7 - IXDD408 Typical Waveform F=500KHz, CL=10000pF

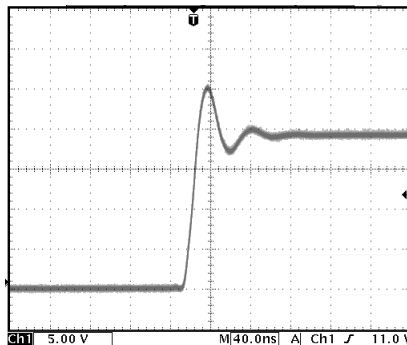

Figure 8 - IXDD414 11ns Gate Rise Time CL=2500pF

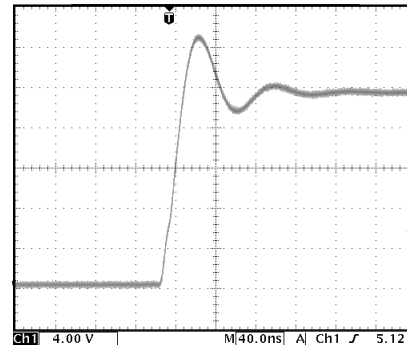

Figure 9 - IXDD414 18ns Gate Rise Time CL=10000pF, R4 & R5=0Ω

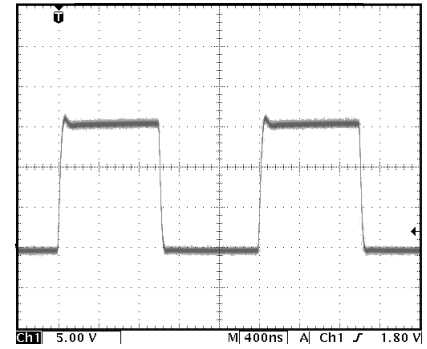

Figure 10 - IXDD414 Typical Waveform F=500KHz, CL=10000pF

NOTE: The capacitive loads used to generate the waveforms above are fixed value ceramic components. All measurements are made at the GATE test point.

IXYS Corporation
 3540 Bassett St; Santa Clara, CA 95054
 Tel: 408-982-0700; Fax: 408-496-0670
 e-mail: sales@ixys.net
 www.ixys.com

IXYS Semiconductor GmbH
 Edisonstrasse15 ; D-68623; Lampertheim
 Tel: +49-6206-503-0; Fax: +49-6206-503627
 e-mail: marcom@ixys.de

Directed Energy, Inc.
 An IXYS Company
 2401 Research Blvd. Ste. 108
 Ft. Collins, CO 80526
 Tel: 970-493-1901; Fax: 970-493-1903
 e-mail: deiinfo@directedenergy.com
 www.directedenergy.com