

N-Channel JFETs

Product Summary

Part Number	V _{GS(off)} (V)	r _{DS(on)} Max (Ω)	I _{D(off)} Typ (pA)	t _{ON} Typ (ns)
2N5432	-4 to -10	5	10	2.5
2N5433	-3 to -9	7	10	2.5
2N5434	-1 to -4	10	10	2.5

Features

- Low On-Resistance: 2N5432 <5 Ω
- Fast Switching—t_{ON}: 2.5 ns
- High Off-Isolation—I_{D(off)}: 10 pA
- Low Capacitance: 11 pF
- Low Insertion Loss

Benefits

- Low Error Voltage
- High-Speed Analog Circuit Performance
- Negligible “Off-Error,” Excellent Accuracy
- Good Frequency Response
- Eliminates Additional Buffering

Applications

- Analog Switches
- Choppers
- Sample-and-Hold
- Normally “On” Switches
- Current Limiters

Description

The 2N5432/5433/5434 are suitable for high-performance analog switching and amplifier applications. Breakdown voltage characteristics, low on-resistance, and very fast switching make these devices ideal for a wide range of applications.

The hermetically-sealed TO-206AC (TO-52) package is suitable for processing per MIL-S-19500 (see Military Information). For similar products in TO-236 (SOT-23) or TO-226AA (TO-92) packages, see the J/SST108 series data sheet.

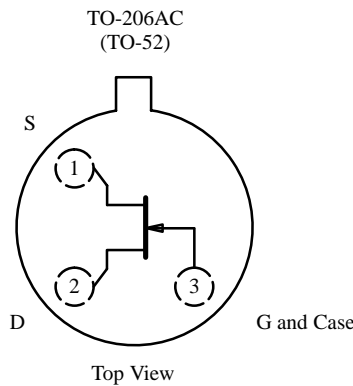

Absolute Maximum Ratings

Gate-Drain, Gate-Source Voltage	-25 V	Operating Junction Temperature	-55 to 150°C
Gate Current	100 mA	Power Dissipation ^a	300 mW
Lead Temperature (1/16" from case for 10 sec.)	300°C	Notes	
Storage Temperature	-65 to 200°C	a. Derate 2.4 mW/°C above 25°C	

Updates to this data sheet may be obtained via facsimile by calling Siliconix FaxBack, 1-408-970-5600. Please request FaxBack document #70245.

2N5432/5433/5434

Specifications^a

Parameter	Symbol	Test Conditions	Typ ^b	Limits						Unit
				2N5432		2N5433		2N5434		
				Min	Max	Min	Max	Min	Max	
Static										
Gate-Source Breakdown Voltage	$V_{(BR)GSS}$	$I_G = -1 \mu A, V_{DS} = 0 V$	-32	-25		-25		-25		V
Gate-Source Cutoff Voltage	$V_{GS(off)}$	$V_{DS} = 5 V, I_D = 3 nA$		-4	-10	-3	-9	-1	-4	
Saturation Drain Current ^c	I_{DSS}	$V_{DS} = 15 V, V_{GS} = 0 V$		150		100		30		mA
Gate Reverse Current	I_{GSS}	$V_{GS} = -15 V, V_{DS} = 0 V$ $T_A = 150^\circ C$	-5		-200		-200		-200	pA
			-10		-200		-200		-200	nA
Gate Operating Current ^d	I_G	$V_{DG} = 10 V, I_D = 10 mA$	-10							pA
Drain Cutoff Current	$I_{D(off)}$	$V_{DS} = 5 V, V_{GS} = -10 V$ $T_A = 150^\circ C$	10		200		200		200	
			20		200		200		200	nA
Drain-Source On-Voltage	$V_{DS(on)}$	$V_{GS} = 0 V, I_D = 10 mA$			50		70		100	mV
Drain-Source On-Resistance	$r_{DS(on)}$			2	5		7		10	Ω
Gate-Source Forward Voltage ^d	$V_{GS(F)}$	$I_G = 1 mA, V_{DS} = 0 V$	0.7							V
Dynamic										
Common-Source Forward Transconductance ^d	g_{fs}	$V_{DS} = 5 V, I_D = 10 mA$ $f = 1 kHz$	17							mS
Common-Source Output Conductance ^d	g_{os}		600							
Drain-Source On-Resistance	$r_{ds(on)}$	$V_{GS} = 0 V, I_D = 0 mA$ $f = 1 kHz$			5		7		10	Ω
Common-Source Input Capacitance	C_{iss}	$V_{DS} = 0 V, V_{GS} = -10 V$ $f = 1 MHz$	20		30		30		30	pF
Common-Source Reverse Transfer Capacitance	C_{rss}		11		15		15		15	
Equivalent Input Noise Voltage ^d	\bar{e}_n	$V_{DS} = 5 V, I_D = 10 mA$ $f = 1 kHz$	3.5							nV/\sqrt{Hz}
Switching										
Turn-On Time ^c	$t_{d(on)}$	$V_{DD} = 1.5 V, V_{GS(H)} = 0 V$ See Switching Circuit	2		4		4		4	ns
	t_r		0.5		1		1		1	
Turn-Off Time ^c	$t_{d(off)}$		4		6		6		6	
	t_f		18		30		30		30	

Notes

- $T_A = 25^\circ C$ unless otherwise noted.
- Typical values are for DESIGN AID ONLY, not guaranteed nor subject to production testing.
- Pulse test: $PW \leq 300 \mu s$ duty cycle $\leq 3\%$.
- This parameter not registered with JEDEC.

NIP

Typical Characteristics

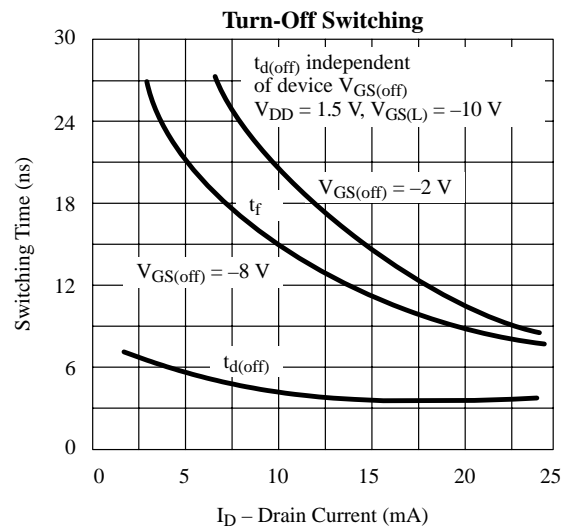
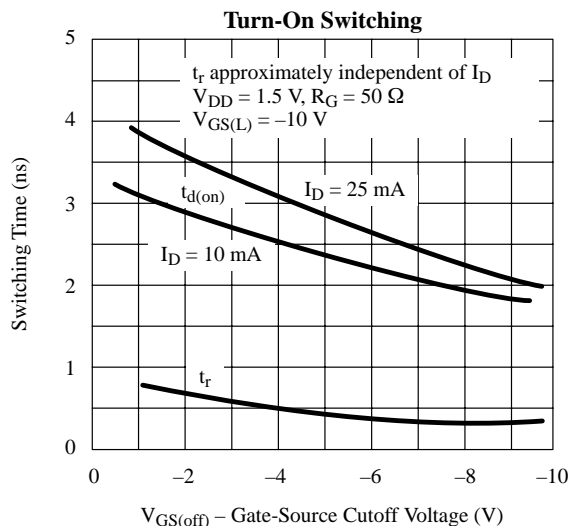
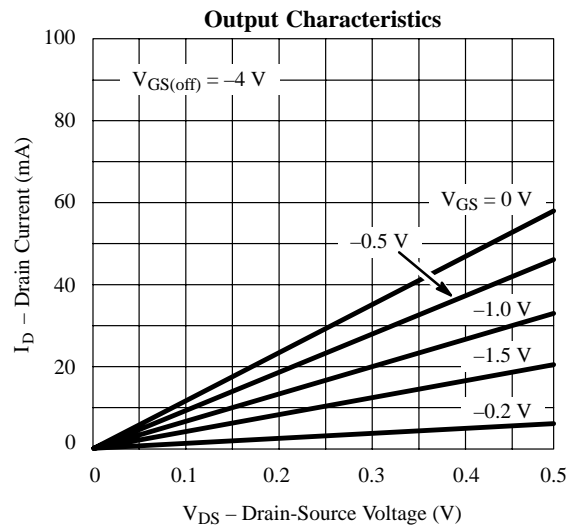
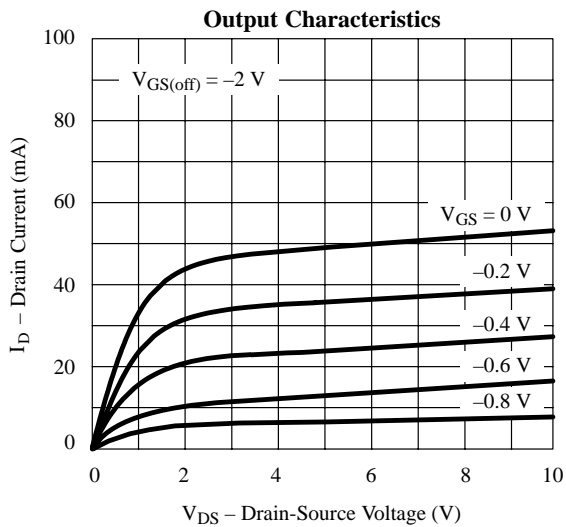
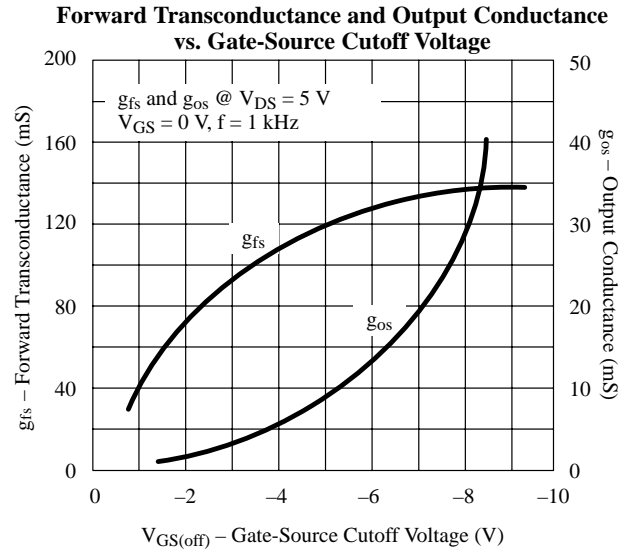
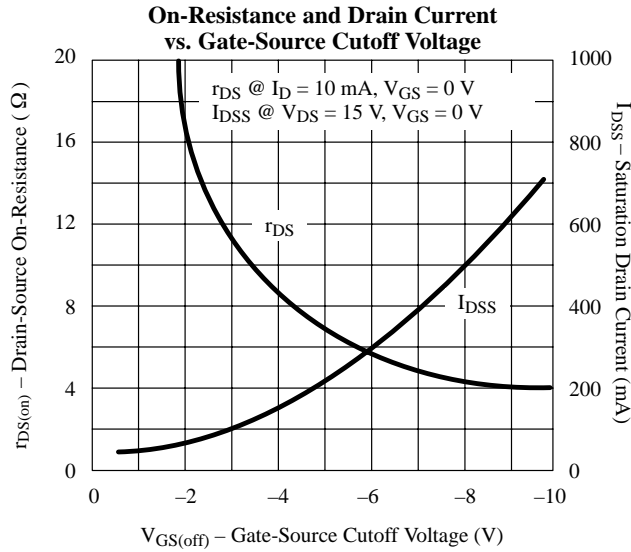

Typical Characteristics (Cont'd)

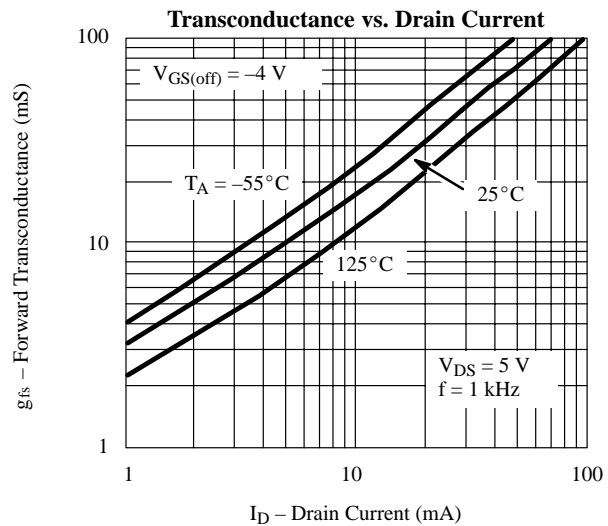
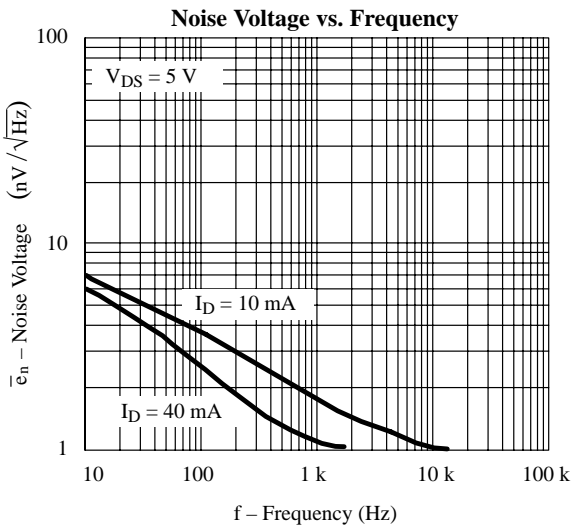
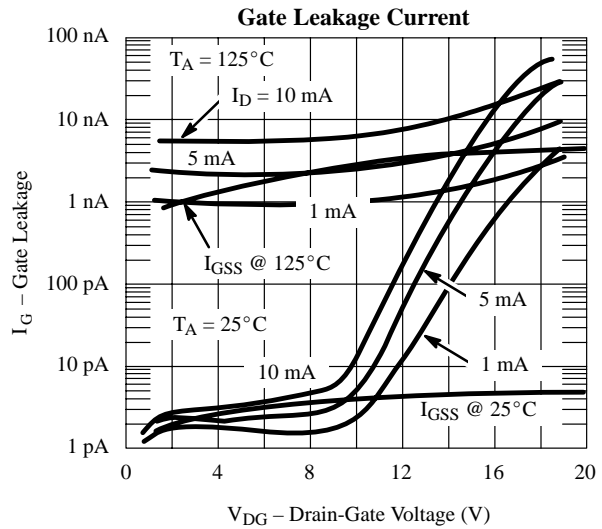
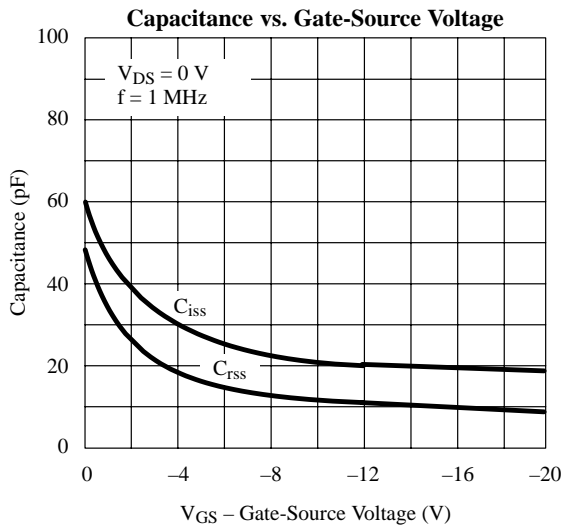
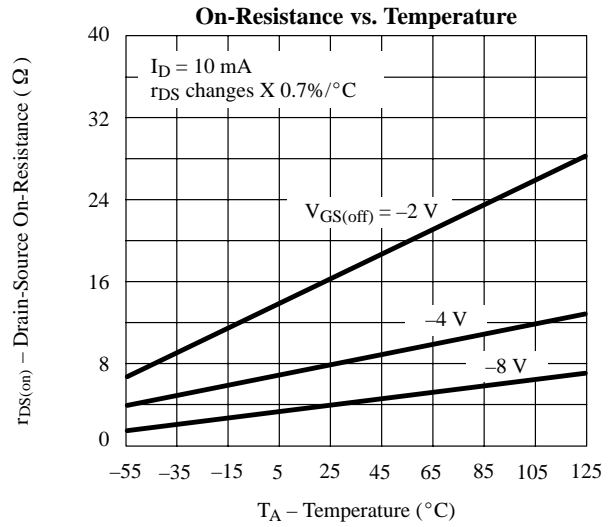
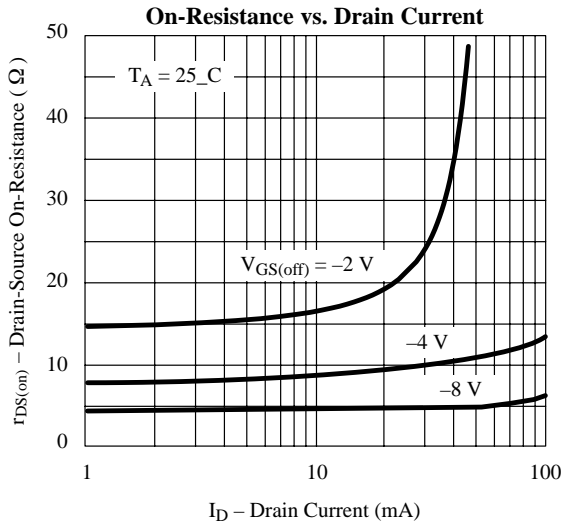

Typical Characteristics (Cont'd)

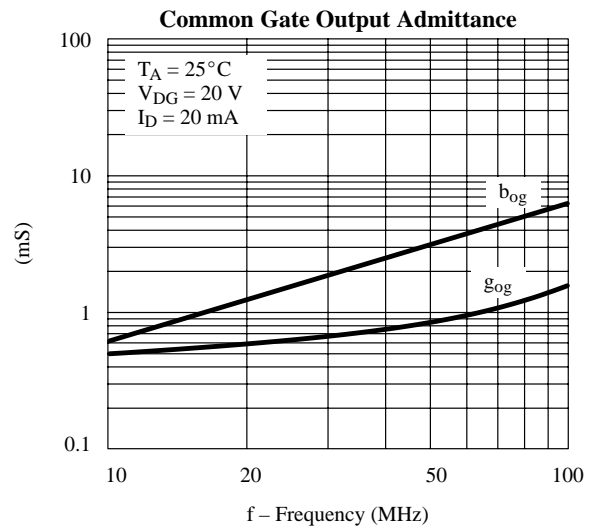
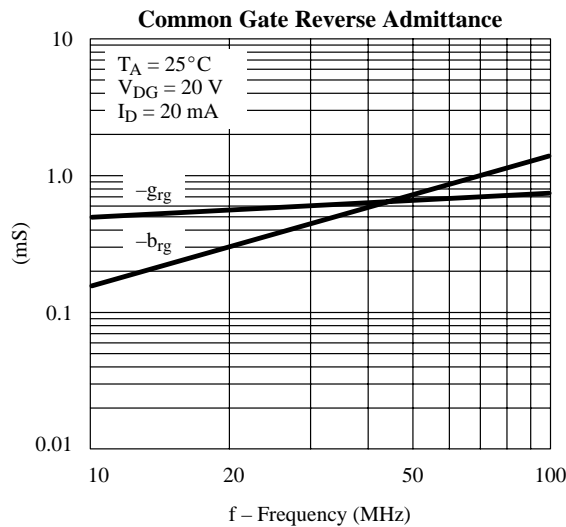
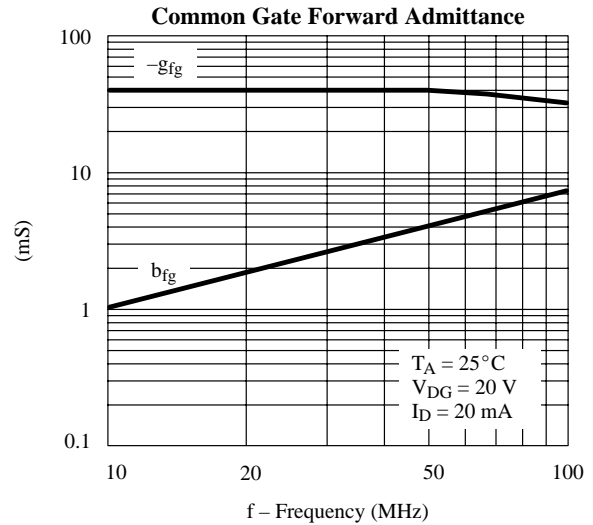
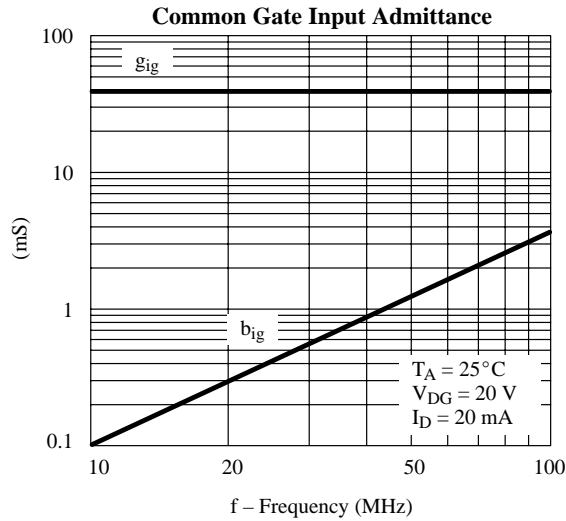

Switching Time Test Circuit

	2N5432	2N5433	2N5434
$V_{GS(L)}$	-12 V	-12 V	-12 V
R_L^*	145 Ω	143 Ω	140 Ω
$I_{D(on)}$	10 mA	10 mA	10 mA

*Non-inductive

Input Pulse

Rise Time < 1 ns
 Fall Time < 1 ns
 Pulse Width 100 ns
 PRF 1 MHz

Sampling Scope

Rise Time 0.4 ns
 Input Resistance 10 M Ω
 Input Capacitance 1.5 pF

