

PE4230

Product Description

The PE4230 SPDT High Power MOSFET RF Switch is designed to cover a broad range of applications from DC to 3.0 GHz. This single-supply reflective switch integrates on-board CMOS control logic driven by a simple, single-pin CMOS or TTL compatible control input. Using a nominal +3-volt power supply, a typical input 1 dB compression point of +32 dBm can be achieved. The PE4230 also exhibits input-output isolation of better than 39 dB at 1.0 GHz and is offered in a small 8-lead MSOP package.

The PE4230 SPDT High Power MOSFET RF Switch is manufactured in Peregrine's patented Ultra Thin Silicon (UTSi®) CMOS process, offering the performance of GaAs with the economy and integration of conventional CMOS.

SPDT High Power MOSFET RF Switch

Features

- Single 3-volt power supply
- Low insertion loss: 0.35 dB at 1.0 GHz, 0.55 dB at 2.0 GHz
- High isolation of 39 dB at 1.0 GHz, 30 dB at 2.0 GHz
- Typical input 1 dB compression point of +32 dBm
- Single-pin CMOS or TTL logic control
- Low cost

Figure 1. Functional Schematic Diagram

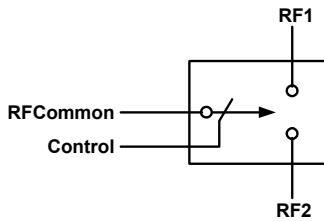

Figure 2. Package Type

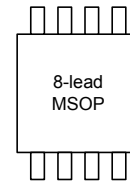
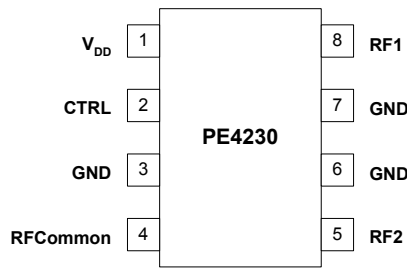

Table 1. Electrical Specifications @ +25 °C, V_{DD} = 3 V (Z_S = Z_L = 50 Ω)

Parameter	Conditions	Minimum	Typical	Maximum	Units
Operation Frequency ¹		DC		3000	MHz
Insertion Loss	1000 MHz		0.35	0.45	dB
	2000 MHz		0.55	0.65	dB
Isolation – RFCommon to RF1/RF2	1000 MHz	38	39		dB
	2000 MHz	28	30		dB
Isolation – RF1 to RF2	1000 MHz	33.5	35		dB
	2000 MHz	26.5	28		dB
Return Loss	1000 MHz	23.5	25.5		dB
	2000 MHz	14.5	15.4		dB
'ON' Switching Time	CTRL to 0.1 dB final value, 2 GHz		200		ns
'OFF' Switching Time	CTRL to 25 dB isolation, 2 GHz		90		ns
Video Feedthrough ²			15		mV _{pp}
Input 1 dB Compression	2000 MHz	30	32		dBm
Input IP3	2000 MHz, 17 dBm	50			dBm

Notes: 1. Device linearity will begin to degrade below 10 MHz.

2. The DC transient at the output of any port of the switch when the control voltage is switched from Low to High or High to Low in a 50Ω test set-up, measured with 1ns risetime pulses and 500 MHz bandwidth.

Figure 3. Pin Configuration

Table 2. Pin Descriptions

Pin No.	Pin Name	Description
1	V _{DD}	Nominal +3V supply connection.
2	CTRL	CMOS or TTL logic level: High = RFCommon to RF1 signal path Low = RFCommon to RF2 signal path
3	GND	Ground connection. Traces should be physically short and connected to ground plane for best performance.
4	RF Common	Common RF port for switch. ¹
5	RF2	RF2 port. ¹
6	GND	Ground Connection. Traces should be physically short and connected to ground plane for best performance.
7	GND	Ground Connection. Traces should be physically short and connected to ground plane for best performance.
8	RF1	RF1 port. ¹

Note 1: All RF pins must be DC blocked with an external series capacitor or held at 0 V_{DC}.

Table 3. Absolute Maximum Ratings

Symbol	Parameter/Conditions	Min	Max	Units
V _{DD}	Power supply voltage	-0.3	4.0	V
V _I	Voltage on any input except for the CTRL input	-0.3	V _{DD} +0.3	V
V _{CTRL}	Voltage on CTRL input		5.0	V
T _{ST}	Storage temperature range	-65	150	°C
T _{OP}	Operating temperature range	-40	85	°C
P _{IN}	Input power (50Ω)		35	dBm
V _{ESD}	ESD voltage (Human Body Model)		250	V

Table 4. DC Electrical Specifications

Parameter	Min	Typ	Max	Units
V _{DD} Power Supply Voltage	2.7	3.0	3.3	V
I _{DD} Power Supply Current (V _{DD} = 3V, V _{CTRL} = 3V)		29	35	μA
Control Voltage High	0.7xV _{DD}			V
Control Voltage Low			0.3xV _{DD}	V

Table 5. Control Logic Truth Table

Control Voltage	Signal Path
CTRL = CMOS or TTL High	RFCommon to RF1
CTRL = CMOS or TTL Low	RFCommon to RF2

The control logic input pin (CTRL) is typically driven by a 3-volt CMOS logic level signal, and has a threshold of 50% of V_{DD}. For flexibility to support systems that have 5-volt control logic drivers, the control logic input has been designed to handle a 5-volt logic HIGH signal. (A minimal current will be sourced out of the V_{DD} pin when the control logic input voltage level exceeds V_{DD}.)

Electrostatic Discharge (ESD) Precautions

When handling this UTSi device, observe the same precautions that you would use with other ESD-sensitive devices. Although this device contains circuitry to protect it from damage due to ESD, precautions should be taken to avoid exceeding the rating specified in Table 3.

Latch-Up Avoidance

Unlike conventional CMOS devices, UTSi CMOS devices are immune to latch-up.

Typical Performance Data @ -40 °C to 85 °C (Unless Otherwise Noted)

Figure 4. Insertion Loss – RFC to RF1

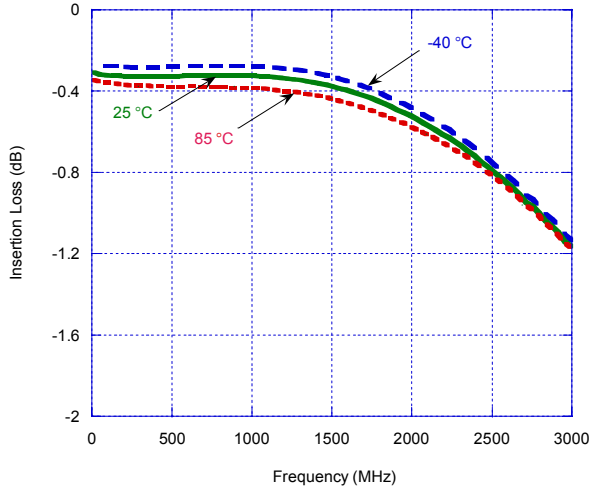

Figure 5. Input 1dB Compression Point

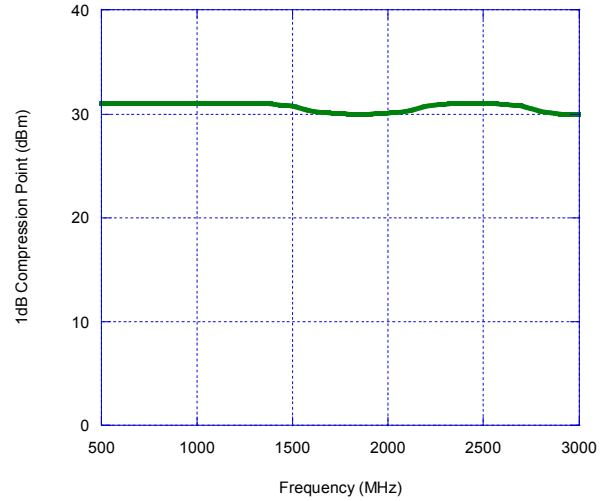

Figure 6. Insertion Loss – RFC to RF2

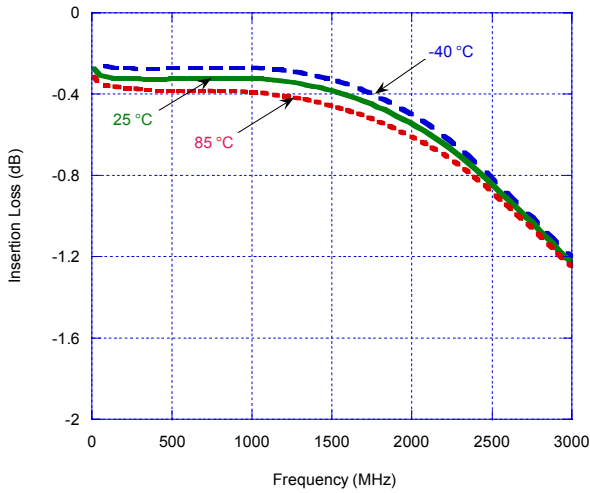
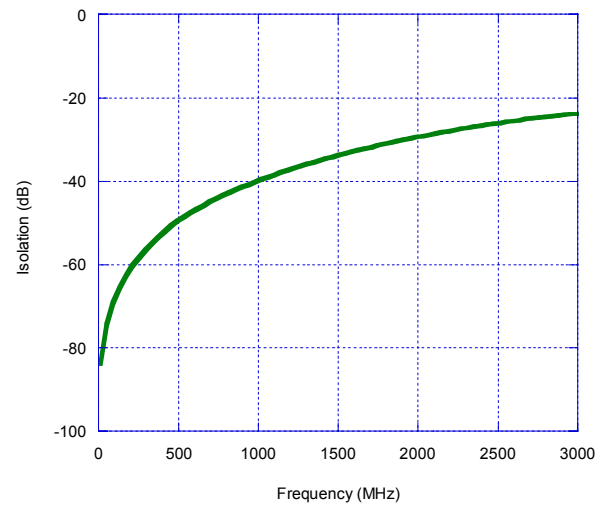

Figure 7. Isolation – RFC to RF1



Typical Performance Data @ -40 °C to 85 °C (Unless Otherwise Noted)

Figure 8. Isolation – RFC to RF2

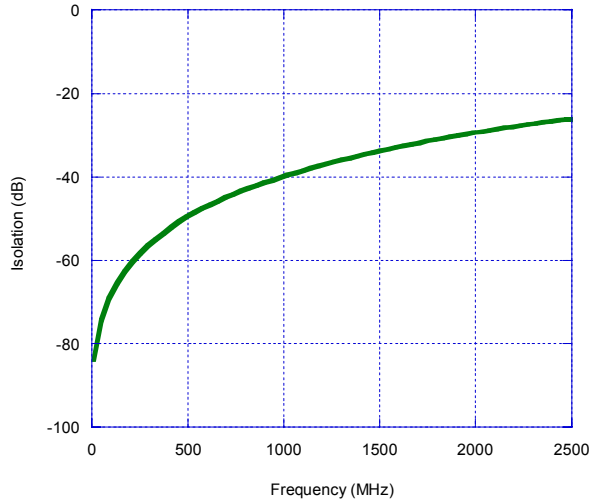

Figure 9. Isolation – RF1/RF2 to RF2/RF1

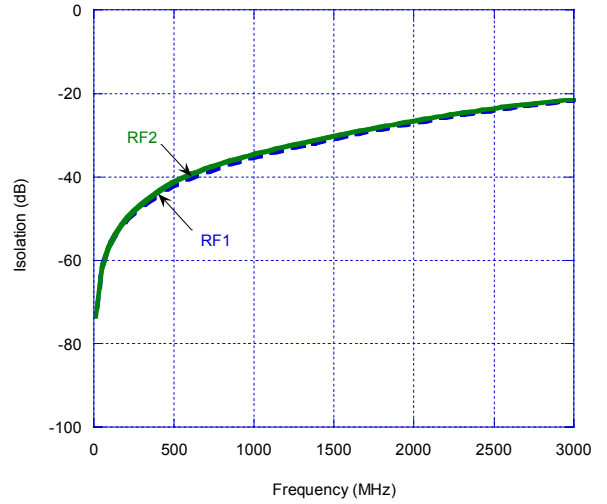

Figure 10. Return Loss – RFC

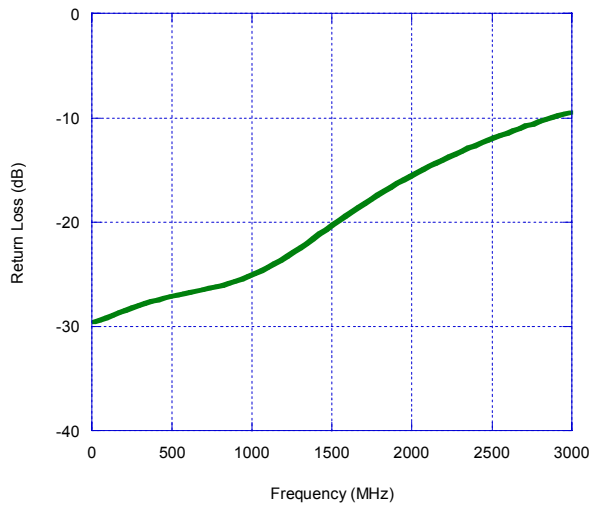
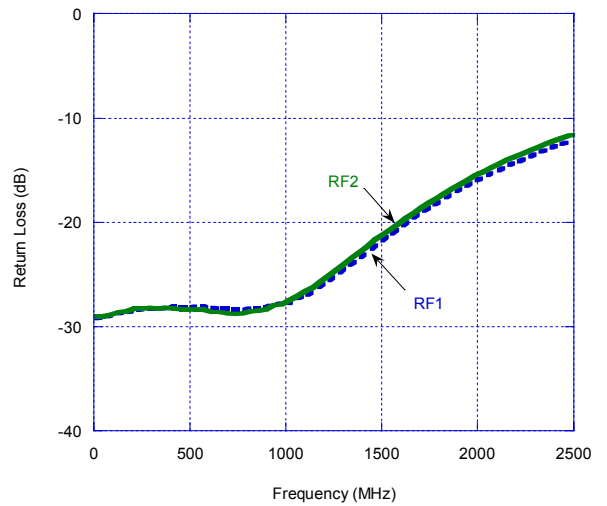

Figure 11. Return Loss – RF1, RF2



Evaluation Kit Information

Evaluation Kit

The SPDT Switch Evaluation Kit board was designed to ease customer evaluation of the PE4230 SPDT switch. The RF common port is connected through a 50Ω transmission line to the top left SMA connector, J1. Port 1 and Port 2 are connected through 50Ω transmission lines to the top two SMA connectors on the right side of the board, J3 and J4. A through transmission line connects SMA connectors J6 and J8. This transmission line can be used to estimate the loss of the PCB over the environmental conditions being evaluated.

The board is constructed of a two metal layer FR4 material with a total thickness of 0.031". The bottom layer provides ground for the RF transmission lines. The transmission lines were designed using a coplanar waveguide with ground plane model using a trace width of 0.030", trace gaps of 0.007", dielectric thickness of 0.028", metal thickness of 0.0014" and ϵ_r of 4.4.

J2 provides a means for controlling DC and digital inputs to the device. Starting from the lower left pin, the second pin to the right (J2-3) is connected to the device CNTL input. The fourth pin to the right (J2-7) is connected to the device V_{DD} input. A decoupling capacitor (100 pF) is provided on both CNTL and V_{DD} traces. It is the responsibility of the customer to determine proper supply decoupling for their design application. Removing these components from the evaluation board has not been shown to degrade RF performance.

Figure 12. Evaluation Board Layouts

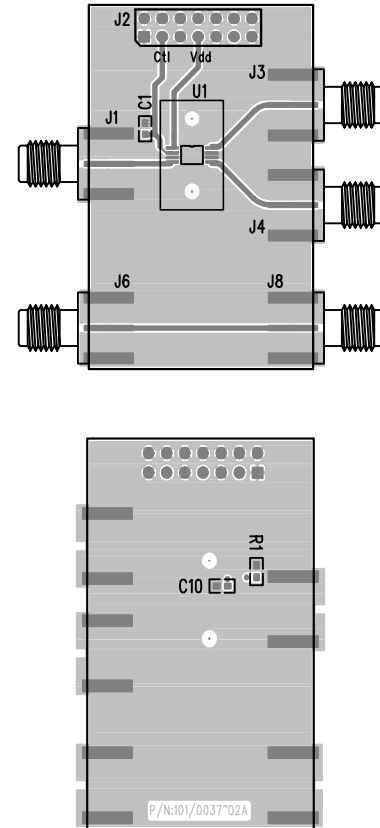

Figure 13. Evaluation Board Schematic

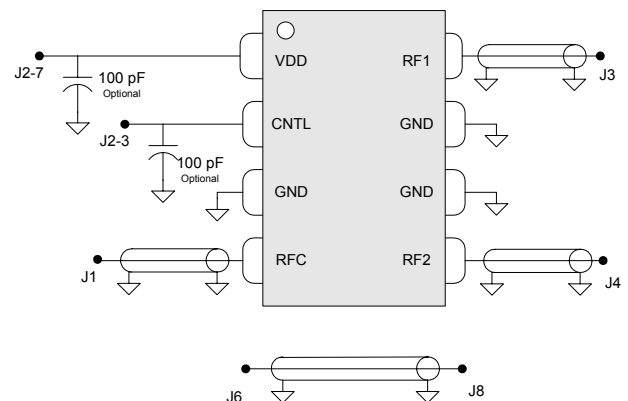

Figure 14. Package Drawing

8-lead MSOP

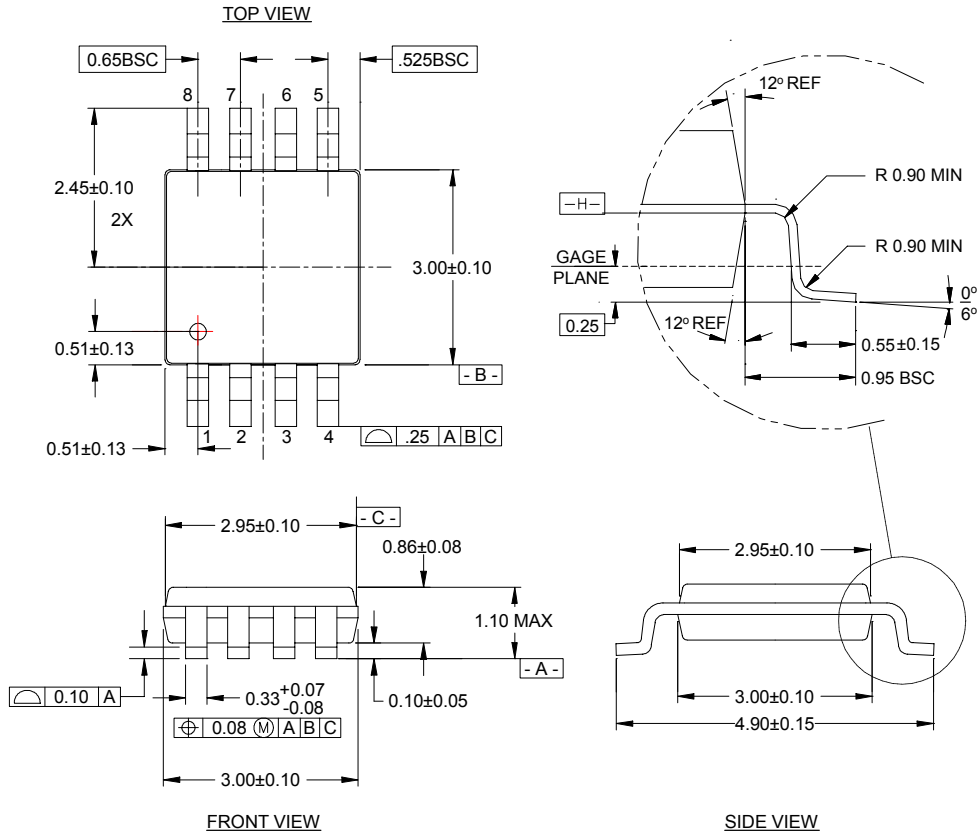

Table 6. Ordering Information

Order Code	Part Marking	Description	Package	Shipping Method
4230-21	4230	PE4230-08MSOP-50A	8-lead MSOP	50 units / Tube
4230-22	4230	PE4230-08MSOP-2000C	8-lead MSOP	2000 units / T&R
4230-00	PE4230-EK	PE4230-08MSOP-EK	Evaluation Kit	1 / Box

Sales Offices

United States

Peregrine Semiconductor Corp.

6175 Nancy Ridge Drive
San Diego, CA 92121
Tel 1-858-455-0660
Fax 1-858-455-0770

Europe

Peregrine Semiconductor Europe

Bâtiment Maine
13-15 rue des Quatre Vents
F- 92380 Garches
Tel 33-1-47-41-91-73
Fax 33-1-47-41-91-73

Japan

Peregrine Semiconductor K.K.

5A-5, 5F Imperial Tower
1-1-1 Uchisaiwaicho, Chiyoda-ku
Tokyo 100-0011 Japan
Tel: 03-3507-5755
Fax: 03-3507-5601

Australia

Peregrine Semiconductor Australia

8 Herb Elliot Ave.
Homebush, NSW 2140
Australia
Tel: 011-61-2-9763-4111
Fax: 011-61-2-9746-1501

For a list of representatives in your area, please refer to our Web site at: <http://www.peregrine-semi.com>

Data Sheet Identification

Advance Information

The product is in a formative or design stage. The data sheet contains design target specifications for product development. Specifications and features may change in any manner without notice.

Preliminary Specification

The data sheet contains preliminary data. Additional data may be added at a later date. Peregrine reserves the right to change specifications at any time without notice in order to supply the best possible product.

Product Specification

The data sheet contains final data. In the event Peregrine decides to change the specifications, Peregrine will notify customers of the intended changes by issuing a PCN (Product Change Notice).

The information in this data sheet is believed to be reliable. However, Peregrine assumes no liability for the use of this information. Use shall be entirely at the user's own risk.

No patent rights or licenses to any circuits described in this data sheet are implied or granted to any third party.

Peregrine's products are not designed or intended for use in devices or systems intended for surgical implant, or in other applications intended to support or sustain life, or in any application in which the failure of the Peregrine product could create a situation in which personal injury or death might occur. Peregrine assumes no liability for damages, including consequential or incidental damages, arising out of the use of its products in such applications.

Peregrine products are protected under one or more of the following U.S. patents: 6,090,648; 6,057,555; 5,973,382; 5,973,363; 5,930,638; 5,920,233; 5,895,957; 5,883,396; 5,864,162; 5,863,823; 5,861,336; 5,663,570; 5,610,790; 5,600,169; 5,596,205; 5,572,040; 5,492,857; 5,416,043. Other patents are pending.

*Peregrine, the Peregrine logotype, Peregrine Semiconductor Corp., and UTSi are registered trademarks of Peregrine Semiconductor Corporation.
Copyright © 2003 Peregrine Semiconductor Corp. All rights reserved.*