

DATA SHEET



PCF8531

34 × 128 pixel matrix driver

Product specification
Supersedes data of 1999 Aug 10
File under Integrated Circuits, IC12

2000 Feb 11

34 × 128 pixel matrix driver**PCF8531**

CONTENTS	9	I²C-BUS INTERFACE
1	9.1	Characteristics of the I ² C-bus
2	9.1.1	Bit transfer
3	9.1.2	START and STOP conditions
4	9.1.3	System configuration
5	9.1.4	Acknowledge
6	9.2	I ² C-bus protocol
7	9.3	Command decoder
8	10	LIMITING VALUES
8.1	11	HANDLING
8.2	12	DC CHARACTERISTICS
8.3	13	AC CHARACTERISTICS
8.4	14	APPLICATION INFORMATION
8.5	15	BONDING PAD LOCATIONS
8.6	16	DEVICE PROTECTION DIAGRAM
8.7	17	TRAY INFORMATION
8.8	18	DEFINITIONS
8.9	19	LIFE SUPPORT APPLICATIONS
8.10	20	PURCHASE OF PHILIPS I²C COMPONENTS
8.11		
8.12		
8.13		
8.14		
8.15		
8.16		
8.17		
8.18		
8.18.1		
8.18.2		
8.18.3		
8.18.4		
8.18.5		
8.18.6		
8.18.7		
8.18.8		
8.18.9		
8.18.10		
8.18.11		

34 × 128 pixel matrix driver

PCF8531

1 FEATURES

- Single-chip LCD controller/driver
- 34 row and 128 column outputs
- Display data RAM 34 × 128 bits
- 128 icons (last row is used for icons)
- Fast mode I²C-bus interface (400 kbit/s)
- Software selectable multiplex rates: 1 : 17, 1 : 26 and 1 : 34
- Icon mode with Mux rate 1 : 2:
 - Featuring reduced current consumption while displaying icons only.
- On-chip:
 - Generation of V_{LCD} (external supply also possible)
 - Selectable linear temperature compensation
 - Oscillator requires no external components (external clock also possible)
 - Generation of intermediate LCD bias voltages
 - Power-on reset.
- No external components required
- Software selectable bias configuration
- Logic supply voltage range V_{DD1} to V_{SS1} 1.8 to 5.5 V
- Supply voltage range for on-chip voltage generator V_{DD2} and V_{DD3} to V_{SS1} and V_{SS2} 2.5 to 4.5 V
- Display supply voltage range V_{LCD} to V_{SS}:
 - Normal mode 4 to 9 V
 - Icon mode 3 to 9 V.
- Low power consumption, suitable for battery operated systems
- CMOS compatible inputs
- Manufactured in silicon gate CMOS process.

**2 APPLICATIONS**

- Telecommunication systems
- Automotive information systems
- Point-of-sale terminals
- Instrumentation.

3 GENERAL DESCRIPTION

The PCF8531 is a low power CMOS LCD row/column driver, designed to drive dot matrix graphic displays at multiplex rates of 1 : 17, 1 : 26 and 1 : 34. Furthermore, it can drive up to 128 icons. All necessary functions for the display are provided in a single chip, including on-chip generation of V_{LCD} and the LCD bias voltages, resulting in a minimum of external components and low power consumption. The PCF8531 is compatible with most microcontrollers and communicates via a two-line bidirectional bus (I²C-bus). All inputs are CMOS compatible.

Remark: The icon mode is used to save current. When only icons are displayed, a much lower operating voltage (V_{LCD}) can be used and the switching frequency of the LCD outputs is reduced. In most applications it is possible to use V_{DD} as V_{LCD}.

4 PACKAGES

The PCF8531 is available as chip with bumps in tray.

5 ORDERING INFORMATION

TYPE NUMBER	PACKAGE		
	NAME	DESCRIPTION	VERSION
PCF8531U/2	–	chip with bumps in tray	–

34 × 128 pixel matrix driver

PCF8531

6 BLOCK DIAGRAM

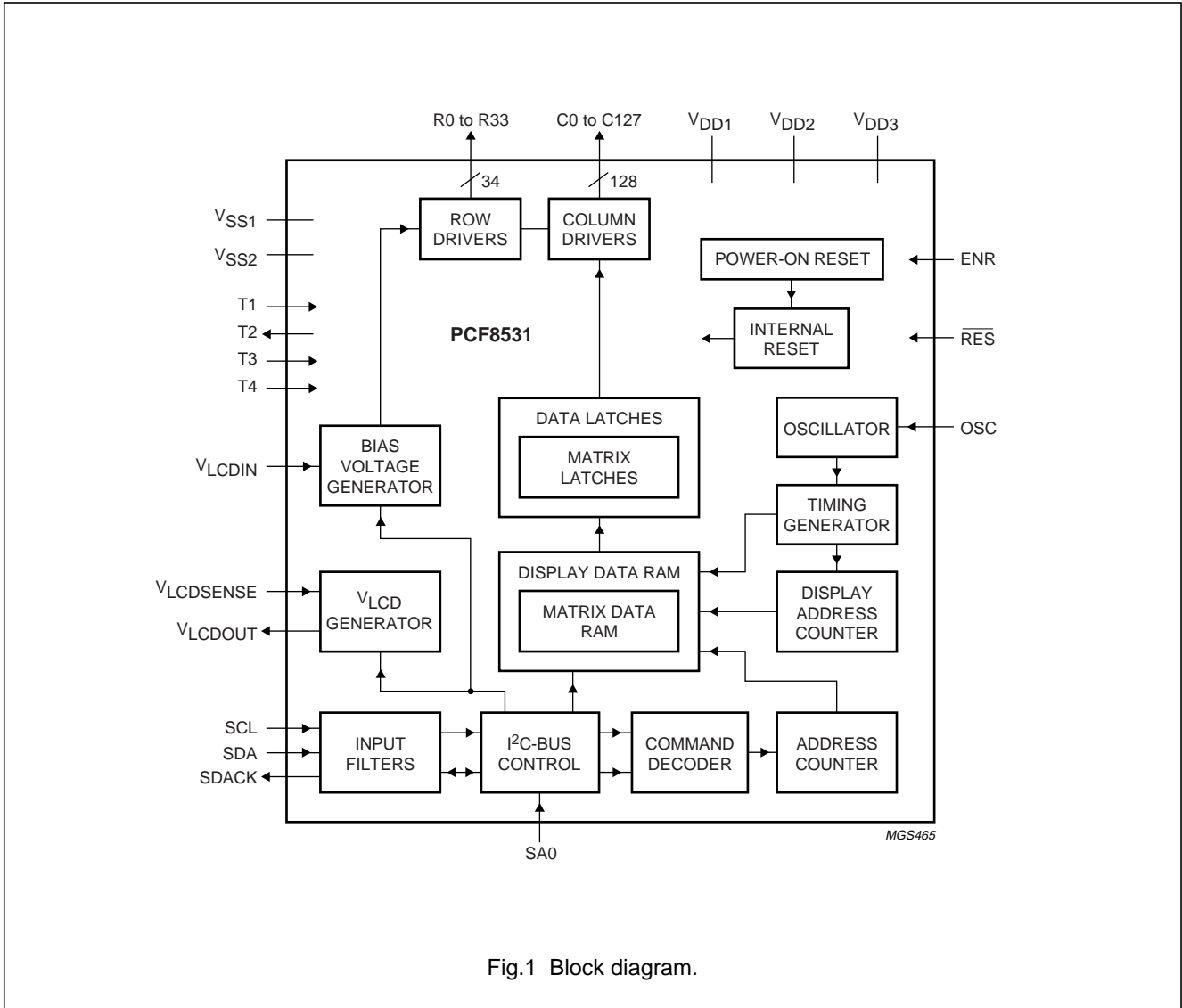

Fig.1 Block diagram.

34 × 128 pixel matrix driver

PCF8531

7 PINNING

SYMBOL	PAD	DESCRIPTION
	1 to 14	dummy pads
OSC	15	oscillator input; note 1
V _{LCDS} ENSE	16	voltage multiplier regulation input (V _{LCD}); note 2
V _{LCD} OUT	17 to 23	voltage multiplier output (V _{LCD}); note 3
V _{LCD} IN	24 to 30	LCD supply voltage (V _{LCD}); note 2
RES	31	external reset input (active LOW); note 4
V _{DD3}	32 to 34	supply voltage 3; note 5
V _{DD2}	35 to 42	supply voltage 2; note 5
V _{DD1}	43 to 49	supply voltage 1; note 5
SDA	50 and 51	serial data line input of the I ² C-bus
SDACK	52	serial data acknowledge output; note 6
	53	dummy pad
SA0	54	I ² C-bus slave address input; bit 0
ENR	55	enable internal Power-on reset input; note 7
T4	56	test 4 input; note 8
V _{SS2}	57 to 63	ground 2; note 9
V _{SS1}	64 to 70	ground 1; note 9
T3	71	test 3 input; note 8
T1	72	test 1 input; note 8
SCL	73 and 74	serial clock line input of the I ² C-bus
	75 to 77	dummy pads
T2	78	test 2 output; note 10
	79 to 86	dummy pads
R0	87	LCD row driver output
R2	88	LCD row driver output
R4	89	LCD row driver output
R6	90	LCD row driver output
R8	91	LCD row driver output
R10	92	LCD row driver output
R12	93	LCD row driver output
R14	94	LCD row driver output
R16	95	LCD row driver output
R18	96	LCD row driver output
R20	97	LCD row driver output
R22	98	LCD row driver output
R24	99	LCD row driver output
R26	100	LCD row driver output
R28	101	LCD row driver output
R30	102	LCD row driver output
R32	103	LCD row driver output

34 × 128 pixel matrix driver

PCF8531

SYMBOL	PAD	DESCRIPTION
C0 to C127	104 to 231	LCD column driver outputs
R33	232	LCD row driver output; icon row
R31	233	LCD row driver output
R29	234	LCD row driver output
R27	235	LCD row driver output
R25	236	LCD row driver output
R23	237	LCD row driver output
R21	238	LCD row driver output
R19	239	LCD row driver output
R17	240	LCD row driver output
R15	241	LCD row driver output
R13	242	LCD row driver output
R11	243	LCD row driver output
R9	244	LCD row driver output
R7	245	LCD row driver output
R5	246	LCD row driver output
R3	247	LCD row driver output
R1	248	LCD row driver output

Notes

1. If the on-chip oscillator is used, this input must be connected to V_{DD1} .
2. If the internal V_{LCD} generation is used, V_{LCDOUT} , V_{LCDIN} and $V_{LCDSENSE}$ must be connected together.
3. If an external V_{LCD} is used in the application, then pin V_{LCDOUT} must be left open circuit, otherwise the chip will be damaged.
4. If only the internal Power-on reset is used, this input must be connected to V_{DD1} .
5. V_{DD1} is for the logic supply, V_{DD2} , and V_{DD3} are for the voltage multiplier. For split power supplies, V_{DD2} and V_{DD3} must be connected together. If only one supply voltage is available, V_{DD1} , V_{DD2} and V_{DD3} must be connected together.
6. Serial data acknowledge for the I²C-bus. By connecting $SDACK$ to SDA externally, the SDA line becomes fully I²C-bus compatible. Having the acknowledge output separated from the serial data line is advantageous in Chip-On-Glass (COG) applications. In COG applications where the track resistance from the $SDACK$ pad to the system SDA line can be significant, a potential divider is generated by the bus pull-up resistor and the Indium Tin Oxide (ITO) track resistance. It is possible that the PCF8531 will not be able to create a valid logic 0 level during the acknowledge cycle. By splitting the SDA input from the $SDACK$ output, the device could be used in a mode that ignores the acknowledge bit. In COG applications where the acknowledge cycle is required, it is necessary to minimize the track resistance from the $SDACK$ pad to the system SDA line to guarantee a valid LOW level.
7. If ENR is connected to V_{SS} , Power-on reset is disabled; to enable Power-on reset ENR should be connected to V_{DD1} .
8. In the application, this input must be connected to V_{SS} .
9. V_{SS1} and V_{SS2} must be connected together.
10. In the application, $T2$ must be left open circuit.

34 × 128 pixel matrix driver**PCF8531**

8 FUNCTIONAL DESCRIPTION**8.1 Oscillator**

The on-chip oscillator provides the clock signal for the display system. No external components are required and the OSC input must be connected to V_{DD} . An external clock signal, if used, is connected to this input.

8.2 Power-on reset

The on-chip Power-on reset initializes the chip after Power-on or power failure.

8.3 I²C-bus controller

The I²C-bus controller receives and executes the commands. The PCF8531 acts as an I²C-bus slave receiver and therefore cannot control bus communication.

8.4 Input filters

To enhance noise immunity in electrically adverse environments, RC low-pass filters are provided on the SDA and SCL lines.

8.5 Display data RAM

The PCF8531 contains a 34 × 128 bits static RAM, which stores the display data. The RAM is divided into 6 banks of 128 bytes (6 × 8 × 128 bits). Bank 6 is used for icon data. During RAM access, data is transferred to the RAM via the I²C-bus interface. There is a direct correspondence between the X address and column output number.

8.6 Timing generator

The timing generator produces the various signals required to drive the internal circuitry. Internal chip operation is not disturbed by operations on the data buses.

8.7 Address counter

The address counter sets the addresses of the display data RAM for writing.

8.8 Display address counter

The display address counter generates the addresses for read out of the display data.

8.9 Command decoder

The command decoder identifies command words that arrive on the I²C-bus and determines the destination for the following data bytes.

8.10 Bias voltage generator

The bias voltage generator generates four buffered intermediate bias voltages. This block contains the generator for the reference voltages and the four buffers. This block can operate in two voltage ranges:

- Normal mode; 4.0 to 9.0 V
- Power save mode; 3.0 to 9.0 V.

8.11 V_{LCD} generator

The V_{LCD} voltage generator contains a configurable 2 to 5 times voltage multiplier; this is software programmable.

8.12 Reset

The PCF8531 has the possibility of two reset modes, internal Power-on reset or external reset (\overline{RES}). The reset mode is selected using the ENR signal. After a reset, the chip has the following state:

- All row and column outputs are set to V_{SS} (display off)
- RAM data is undefined
- Power-down mode.

8.13 Power-down

During power-down, all static currents are switched off (no internal oscillator, no timing and no LCD segment drive system), and all LCD outputs are internally connected to V_{SS} . The I²C-bus function remains operational.

8.14 Column driver outputs

The LCD drive section includes 128 column outputs (C0 to C127) which should be connected directly to the LCD. The column output signals are generated in accordance with the multiplexed row signals and with the data in the display latch. When less than 128 columns are required, the unused column outputs should be left open circuit.

8.15 Row driver outputs

The LCD drive section includes 34 row outputs (R0 to R33), which should be connected directly to the LCD. The row output signals are generated in accordance with the selected LCD drive mode. If less than 34 rows or lower Mux rates are required, the unused outputs must be left open circuit. The row signals are interlaced i.e. the selection order is R0, R2, ..., R1, R3 etc.

34 × 128 pixel matrix driver

PCF8531

8.16 LCD waveforms and DDRAM to data mapping

The LCD waveforms and the DDRAM to display data mapping are shown in Figs 2, 3 and 4.

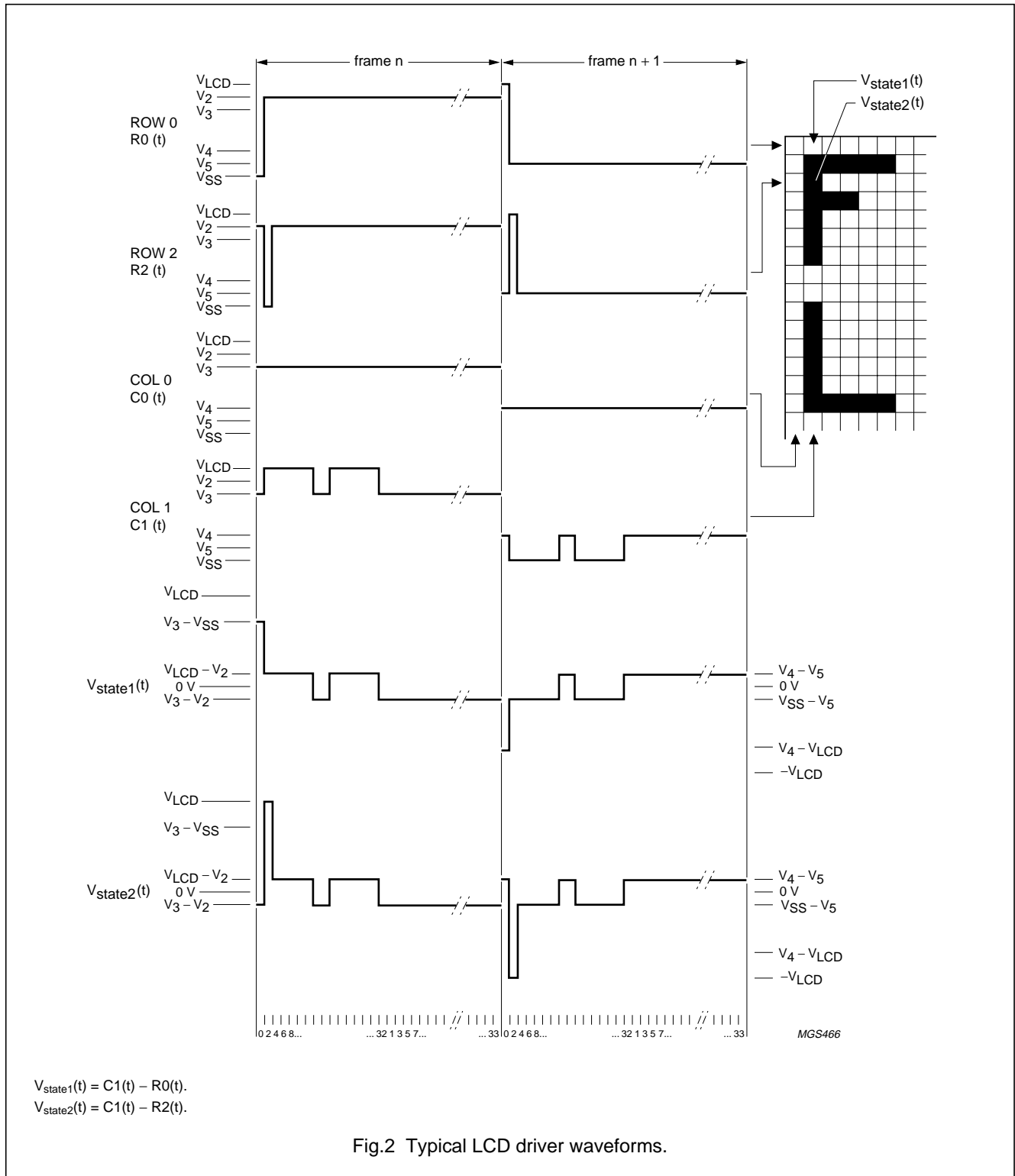

Fig.2 Typical LCD driver waveforms.

34 × 128 pixel matrix driver

PCF8531

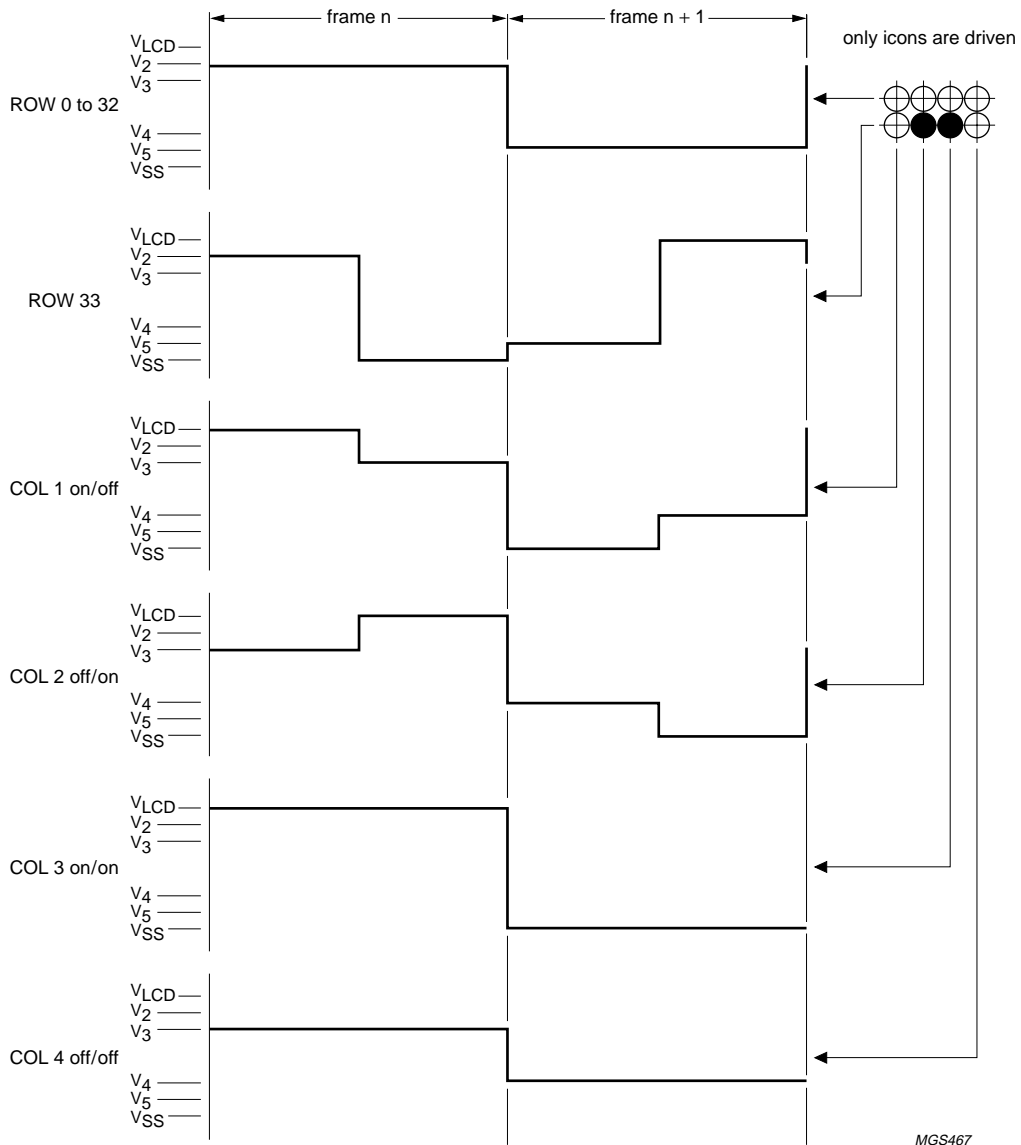

Fig.3 Icon mode; Mux 1 : 2 LCD waveforms.

34 × 128 pixel matrix driver

PCF8531

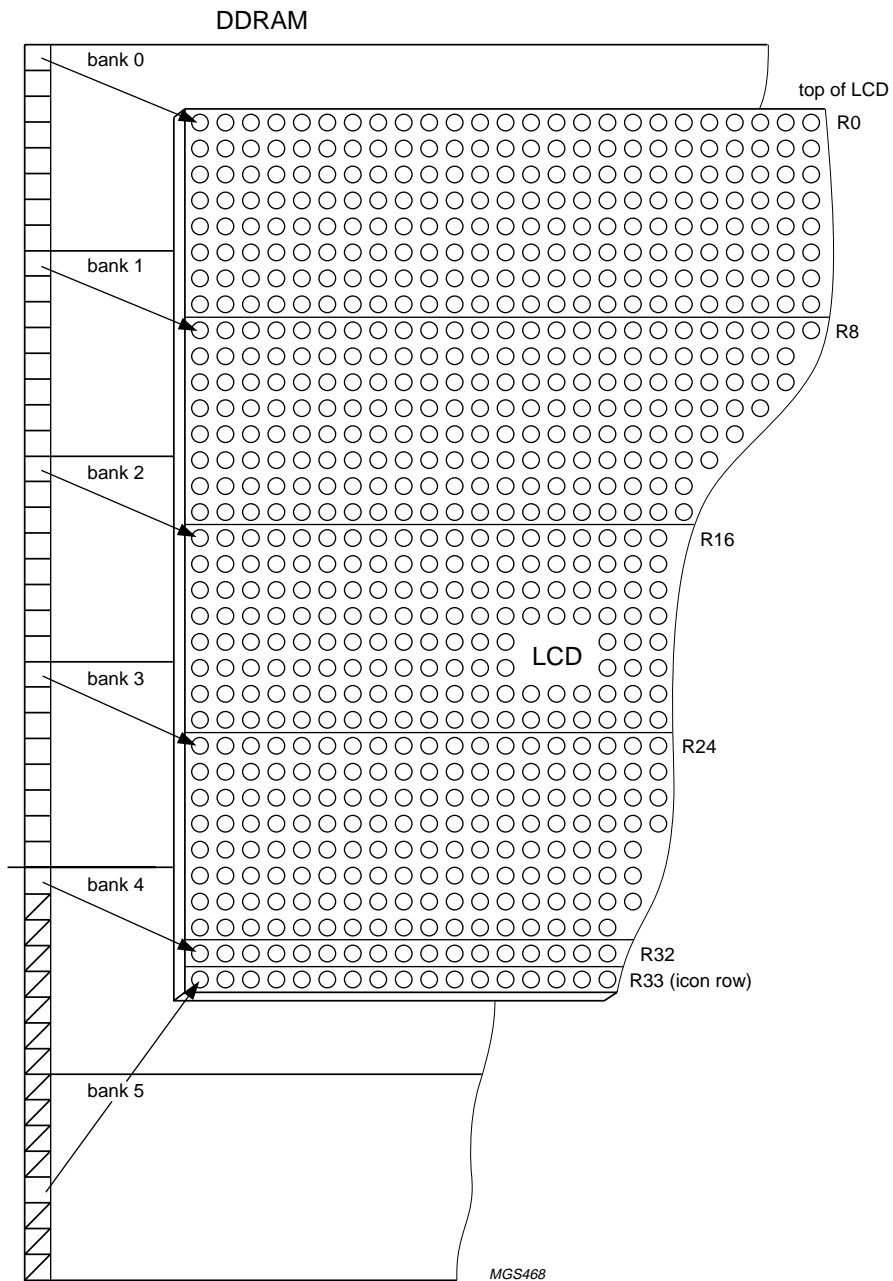

Fig.4 DDRAM to display mapping.

34 × 128 pixel matrix driver

PCF8531

8.17 Addressing

Data is written in bytes into the RAM matrix of the PCF8531 as illustrated in Figs 5, 6 and 7. The display RAM has a matrix of 34 × 128 bits. The columns are addressed by the address pointer. The address ranges are X 0 to X 127 (7FH) and Y 0 to Y 5 (5H). Addresses outside of these ranges are not allowed. In vertical addressing mode (V = 1), the Y address increments after each byte (see Fig.6). After the last Y address (Y = 4), Y wraps around to 0 and X increments to address the next

column. In horizontal addressing mode (V = 0), the X address increments after each byte (see Fig.7). After the last X address (X = 127), X wraps around to 0 and Y increments to address the next row. After the very last address (X = 127 and Y = 4), the address pointers wrap around to address (X = 0 and Y = 0). It should be noted that in bank 4 only the LSB (DB0) of the data will be written into the RAM. The Y address 5 is reserved for icon data and is not affected by the addressing mode; it should be noted that in bank 5 only the 5th data bit (DB4) will be written into the RAM.

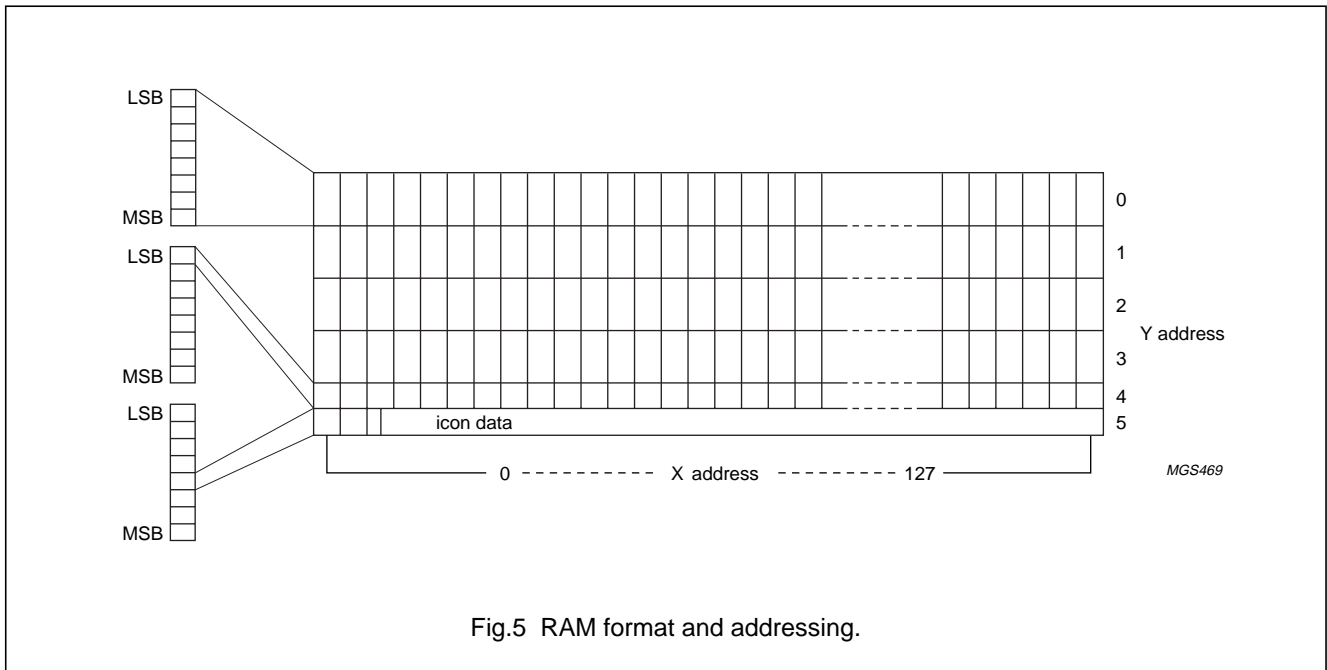

Fig.5 RAM format and addressing.

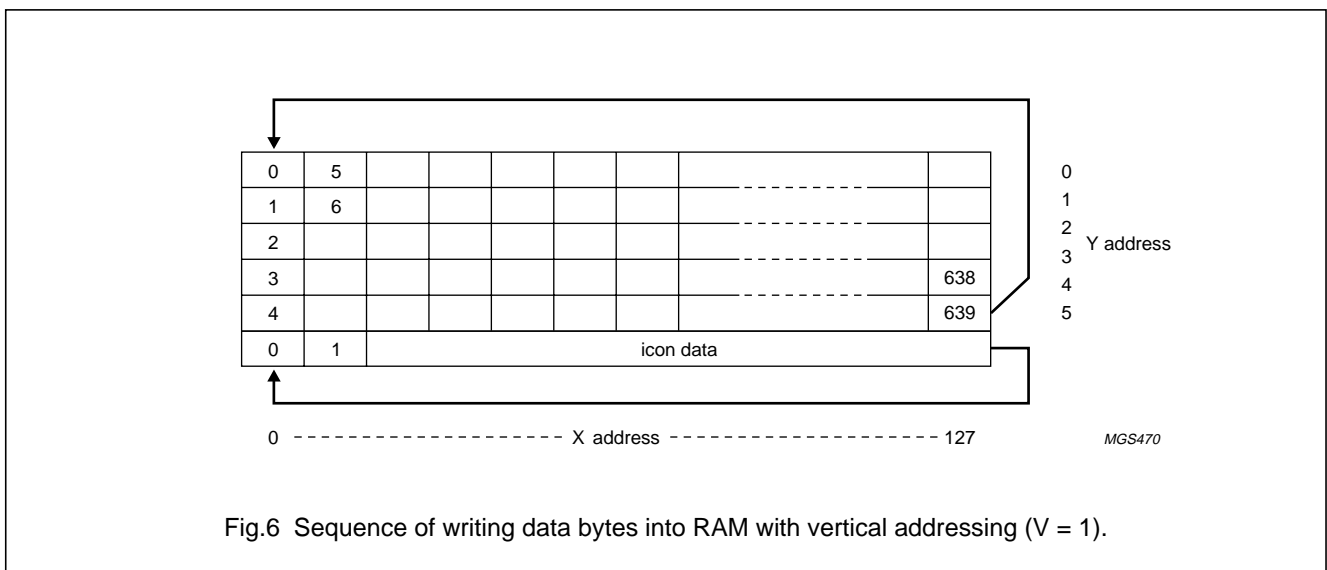

Fig.6 Sequence of writing data bytes into RAM with vertical addressing (V = 1).

34 × 128 pixel matrix driver

PCF8531

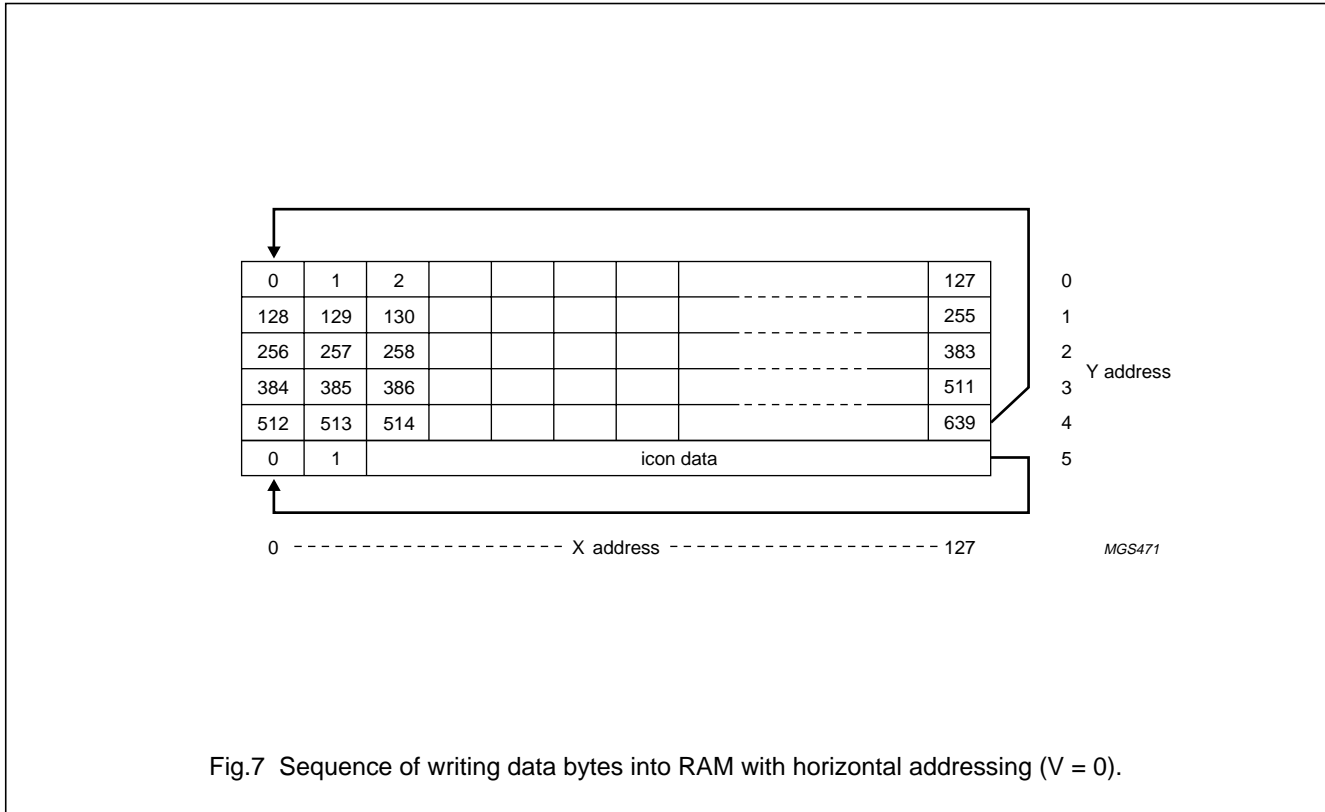

Fig.7 Sequence of writing data bytes into RAM with horizontal addressing (V = 0).

8.18 Instructions

Only two PCF8531 registers, the Instruction Register (IR) and the Data Register (DR) can be directly controlled by the MPU. Before internal operation, control information is stored temporarily in these registers to allow interfacing to various types of MPUs which operate at different speeds or to allow interfacing to peripheral control ICs. The PCF8531 operation is controlled by the instructions given in Table 1. Details are explained in subsequent sections.

Instructions are of four types:

1. Those that define PCF8531 functions such as display configuration, etc.
2. Those that set internal RAM addresses
3. Those that perform data transfer with internal RAM
4. Others.

In normal use, category 3 instructions are used most frequently. Automatic incrementing by 1 of internal RAM addresses after each data write reduces the MPU program load.

8.18.1 RESET

After reset or internal Power-on reset (depending on application), the LCD driver will be set to the following state:

- Power-down mode (PD = 1)
- Horizontal addressing (V = 0)
- Display blank (D = 0; E = 0), no icon mode (IM = 0)
- Address counter X[6:0] = 0; Y[2:0] = 0
- Bias system BS[2:0] = 0
- Multiplex rate M[1:0] = 0 (Mux rate 1 : 17)
- Temperature control mode TC[2:0] = 0
- HV-gen control, HVE = 0 the HV generator is switched off, PRS = 0 and S[1:0] = 0
- V_{LCD} = 0 V
- RAM data is undefined
- Command page definition H[1:0] = 0.

34 × 128 pixel matrix driver

PCF8531

8.18.2 FUNCTION SET

8.18.2.1 PD

When PD = 1, the Power-down mode of the LCD driver is active:

- All LCD outputs at V_{SS} (display off)
- Power-on reset detection active, oscillator off
- V_{LCD} can be disconnected
- I²C-bus is operational, commands can be executed
- RAM contents not cleared; RAM data can be written
- Register settings remain unchanged.

8.18.2.2 V

When V = 0 the horizontal addressing is selected. The data is written into the DDRAM as shown in Fig.7. When V = 1 the vertical addressing is selected. The data is written into the DDRAM as shown in Fig.6. Icon data is written independently of V when Y address is 5.

8.18.3 SET Y ADDRESS

Bits Y_2 , Y_1 and Y_0 define the Y address vector of the display RAM.

Table 1 Y address

Y_2	Y_1	Y_0	BANK
0	0	0	0
0	0	1	1
0	1	0	2
0	1	1	3
1	0	0	4
1	0	1	5 (icons)

Table 2 Programming the required bias system

BS[2]	BS[1]	BS[0]	n	BIAS SYSTEM	COMMENT
0	0	0	7	$\frac{1}{11}$	
0	0	1	6	$\frac{1}{10}$	
0	1	0	5	$\frac{1}{9}$	
0	1	1	4	$\frac{1}{8}$	
1	0	0	3	$\frac{1}{7}$	recommended for 1 : 34
1	0	1	2	$\frac{1}{6}$	recommended for 1 : 26
1	1	0	1	$\frac{1}{5}$	recommended for 1 : 17
1	1	1	0	$\frac{1}{4}$	recommended for icon mode

8.18.4 SET X ADDRESS

The X address points to the columns. The range of X is 0 to 127 (7FH).

8.18.5 SET MULTIPLEX RATE

M[1:0] selects the multiplex rate (see Table 8).

8.18.6 DISPLAY CONTROL (D, E AND IM)

Bits D and E select the display mode (see Table 6). Bit IM sets the display to icon mode.

8.18.7 SET BIAS SYSTEM

Different multiplex rates require different bias settings. These are programmed by BS[2:0], which sets the binary number n. The optimum value for n is given by

$$n = \sqrt{\text{Mux rate}} - 3$$

Supported values of n are given in Table 2. Table 3 shows the intermediate bias voltages.

34 × 128 pixel matrix driver

PCF8531

8.18.8 LCD BIAS VOLTAGE

Table 3 Intermediate LCD bias voltages

SYMBOL	BIAS VOLTAGES	EXAMPLE FOR 1/7 BIAS
V1	V _{LCD}	V _{LCD}
V2	$\frac{n+3}{n+4} \times V_{LCD}$	$\frac{6}{7} \times V_{LCD}$
V3	$\frac{n+2}{n+4} \times V_{LCD}$	$\frac{5}{7} \times V_{LCD}$
V4	$\frac{2}{n+4} \times V_{LCD}$	$\frac{2}{7} \times V_{LCD}$
V5	$\frac{1}{n+4} \times V_{LCD}$	$\frac{1}{7} \times V_{LCD}$
V6	V _{SS}	V _{SS}

8.18.9 SET V_{OP} VALUE:

The operating voltage V_{LCD} can be set by software. The voltage at reference temperature [V_{LCD} (T = T_{cut})] can be calculated as: V_{LCD} (T_{cut}) = (a + V_{OP} × b).

The generated voltage is dependent on the temperature, programmed Temperature Coefficient (TC) and the programmed voltage at reference temperature (T_{cut}).
 $V_{LCD} = V_{LCD} (T_{cut}) \times [1 + TC \times (T - T_{cut})]$.

The parameter values are given in Table 4. Two overlapping V_{LCD} ranges can be selected via the command 'HV-gen control' (see Table 4 and Fig.8). The maximum voltage that can be generated depends on the V_{DD2} and V_{DD3} voltages and the display load current. For Mux 1 : 34, the optimum operating voltage of the liquid can be calculated as:

$$V_{LCD} = \frac{1 + \sqrt{34}}{\sqrt{2 \times \left(1 - \frac{1}{\sqrt{34}}\right)}} \times V_{th} = 5.30 \times V_{th}$$

Where V_{th} is the threshold voltage of the liquid crystal material used.

The practical value for V_{OP} is determined by equating V_{off(rms)} with a defined LCD threshold voltage (V_{th}), typically when the LCD exhibits approximately 10% contrast.

As the programming range for the internally generated V_{LCD} allows values above the maximum allowed V_{LCD}, the user has to ensure, while setting the V_{OP} register and selecting the temperature compensation, that the V_{LCD} limit of maximum 9 V will never be exceeded under all conditions and including all tolerances.

Table 4 Parameter values for the HV generator programming

SYMBOL	VALUE		UNIT
	PRS = 0	PRS = 1	
T _{cut}	27	27	°C
a	2.94	6.75	V
b	0.03	0.03	V
Programming range	2.94 to 6.75	6.75 to 10.56	V

34 × 128 pixel matrix driver

PCF8531

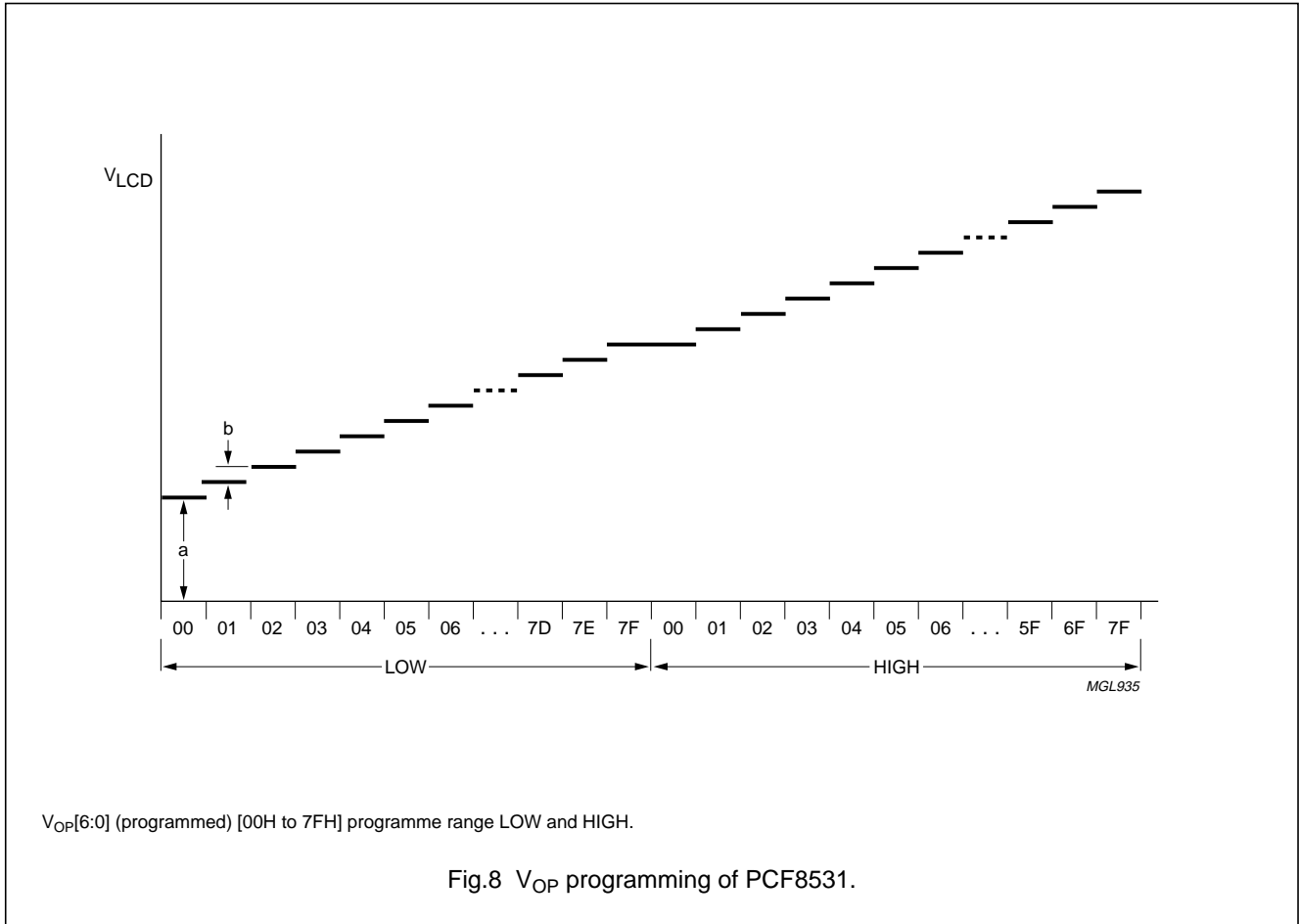

8.18.10 VOLTAGE MULTIPLIER CONTROL S[1:0]

The PCF8531 incorporates a software configurable voltage multiplier. After reset (internal or external), the voltage multiplier is set to $2 \times V_{DD2}$. The voltage multiplier factors are set via the command 'HV-gen configuration' (see Tables 4, 5 and 6).

8.18.11 TEMPERATURE COMPENSATION

Due to the temperature dependency of the liquid crystal's viscosity, the LCD controlling voltage V_{LCD} should usually be increased at lower temperatures to maintain optimum contrast. Figure 9 shows V_{LCD} for high multiplex rates.

Linear temperature compensation is supported in the PCF8531. The temperature coefficient of V_{LCD} can be selected from eight values by setting bits TC[2:0] (see Tables 4, 5 and 6).

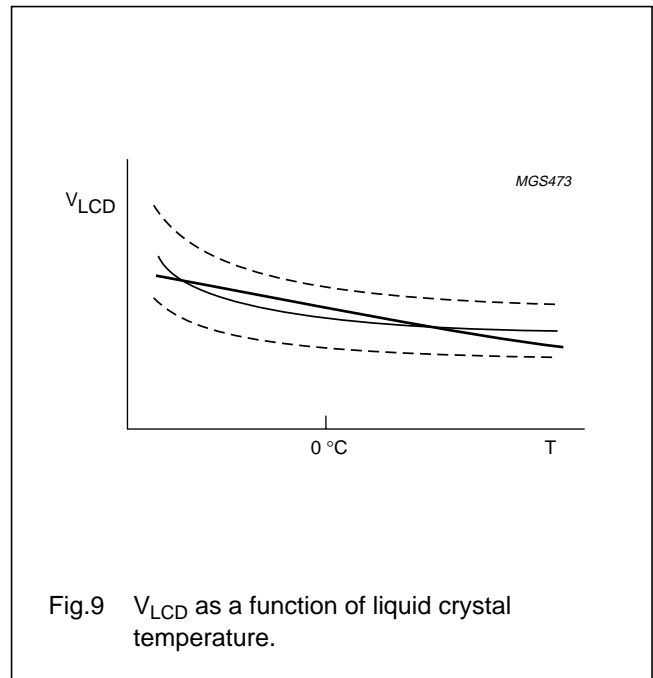

34 × 128 pixel matrix driver

PCF8531

Table 5 Instruction set

INSTRUCTION	I ² C-BUS COMMAND ⁽¹⁾		I ² C-BUS COMMAND BYTE								DESCRIPTION
	RS	R/W	DB7	DB6	DB5	DB4	DB3	DB2	DB1	DB0	
H₁ and H₀ = don't care (H independent command page)											
NOP	0	0	0	0	0	0	0	0	0	0	no operation
Write data	1	0	D ₇	D ₆	D ₅	D ₄	D ₃	D ₂	D ₁	D ₀	write data to display RAM
Set default H[1:0]	0	0	0	0	0	0	0	0	0	1	select H[1:0] = 0
H₁ = 0 and H₀ = 0 (function and RAM command page)											
Instruction set	0	0	0	0	0	0	1	0	H ₁	H ₀	select command page
Function set	0	0	0	0	1	0	0	PD	V	0	power-down control; entry mode
Set Y address of RAM	0	0	0	1	0	0	0	Y ₂	Y ₁	Y ₀	set Y address of RAM; 0 ≤ Y ≤ 5
Set X address of RAM	0	0	1	X ₆	X ₅	X ₄	X ₃	X ₂	X ₁	X ₀	set X address part of RAM; 0 ≤ X ≤ 127
H₁ = 0 and H₀ = 1 (display setting command page)											
Multiplex rate	0	0	0	0	0	0	0	1	M ₁	M ₀	select multiplex rate
Display control	0	0	0	0	0	0	1	D	IM	E	set display configuration
Bias system	0	0	0	0	0	1	0	BS ₂	BS ₁	BS ₀	set Bias System (BSx)
H₁ = 1 and H₀ = 0 (HV-gen command page)											
HV-gen control	0	0	0	0	0	0	0	1	PRS	HVE	set V _{LCD} programming range
HV-gen configuration	0	0	0	0	0	0	1	0	S ₁	S ₀	set voltage multiplication factor
Temperature control	0	0	0	0	1	0	0	TC ₂	TC ₁	TC ₀	set temperature coefficient
Test modes	0	0	0	1	X	X	X	X	X	X	do not use (reserved for test)
V _{LCD} control	0	0	1	V _{OP6}	V _{OP5}	V _{OP4}	V _{OP3}	V _{OP2}	V _{OP1}	V _{OP0}	set V _{LCD} register 0 ≤ V _{OP} ≤ 127

Note

1. R/W is set in the slave address byte; Co and RS are set in the control byte.

34 × 128 pixel matrix driver

PCF8531

Table 6 Explanations for symbols in Table 5

BIT	0	1
PD	chip is active	chip is in Power-down mode
V	horizontal addressing	vertical addressing
IM	normal mode; full display + icons	icon mode; only icons are displayed
H[1:0] ⁽¹⁾	see Table 7	
D and E	see Table 7	
HVE	voltage multiplier disabled	voltage multiplier enabled
PRS	V _{LCD} programming range LOW	V _{LCD} programming range HIGH
TC[2:0]	see Table 7	
S[1:0]	see Table 7	

Note

1. The H-bits identify the command page (use set default H[1:0] command to set H[1:0] = 0).

Table 7 Description of bits H, D and E, TC and S

BITS	VALUE	DESCRIPTION
Command page (H)		
H[1:0]	00	function and RAM command page
	01	display setting command page
	10	HV-gen command page
Display modes (D, E)		
D and E	00	display blank
	10	normal mode
	01	all display segments
	11	inverse video mode
Temperature coefficient (TC)		
TC[2:0]	000	temperature coefficient 0
	001	temperature coefficient 1
	010	temperature coefficient 2
	011	temperature coefficient 3
	100	temperature coefficient 4
	101	temperature coefficient 5
	110	temperature coefficient 6
	111	temperature coefficient 7
Voltage multiplier factor (S)		
S[1:0]	00	2 × voltage multiplier
	01	3 × voltage multiplier
	10	4 × voltage multiplier
	11	5 × voltage multiplier

Table 8 Multiplex rates

MUX RATE	M1	M0
1 : 17	0	0
1 : 26	1	0
1 : 34	0	1

34 × 128 pixel matrix driver

PCF8531

9 I²C-BUS INTERFACE

9.1 Characteristics of the I²C-bus

The I²C-bus is for bi-directional, two-line communication between different ICs or modules. The two lines are a Serial Data line (SDA) and a Serial Clock line (SCL). Both lines must be connected to a positive supply via a pull-up resistor. Data transfer may be initiated only when the bus is not busy.

- Slave: the device addressed by a master
- Multi-Master: more than one master can attempt to control the bus at the same time without corrupting the message
- Arbitration: procedure to ensure that, if more than one master simultaneously tries to control the bus, only one is allowed to do so and the message is not corrupted
- Synchronization: procedure to synchronize the clock signals of two or more devices.

9.1.1 BIT TRANSFER

One data bit is transferred during each clock pulse. The data on the SDA line must remain stable during the HIGH period of the clock pulse as changes in the data line at this time will be interpreted as a control signal (see Fig.10).

9.1.4 ACKNOWLEDGE

Acknowledge on the I²C-bus is illustrated in Fig.13. Each byte of eight bits is followed by an acknowledge bit. The acknowledge bit is a HIGH signal put on the bus by the transmitter, during which time the master generates an extra acknowledge related clock pulse. A slave receiver that is addressed must generate an acknowledge after the reception of each byte.

9.1.2 START AND STOP CONDITIONS

Both data and clock lines remain HIGH when the bus is not busy. A HIGH-to-LOW transition of the data line, while the clock is HIGH is defined as the START condition (S). A LOW-to-HIGH transition of the data line while the clock is HIGH is defined as the STOP condition (P). The START and STOP conditions are illustrated in Fig.11.

Also, a master receiver must generate an acknowledge after the reception of each byte that has been clocked out of the slave transmitter. The device that acknowledges must pull-down the SDA line during the acknowledge clock pulse so that the SDA line is stable LOW during the HIGH period of the acknowledge- related clock pulse (set-up and hold times must be taken into consideration). A master receiver must signal an "end of data" to the transmitter by not generating an acknowledge on the last byte that has been clocked out of the slave. In this event, the transmitter must leave the data line HIGH to enable the master to generate a STOP condition.

9.1.3 SYSTEM CONFIGURATION

The system configuration is illustrated in Fig.12

- Transmitter: the device that sends the data to the bus
- Receiver: the device that receives the data from the bus
- Master: the device that initiates a transfer, generates clock signals and terminates a transfer

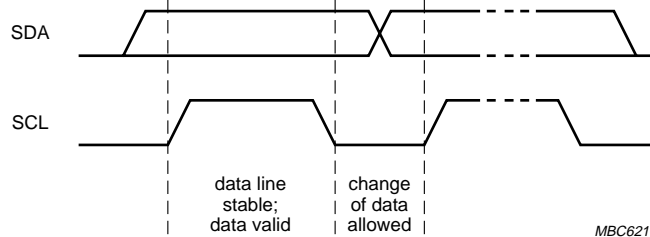
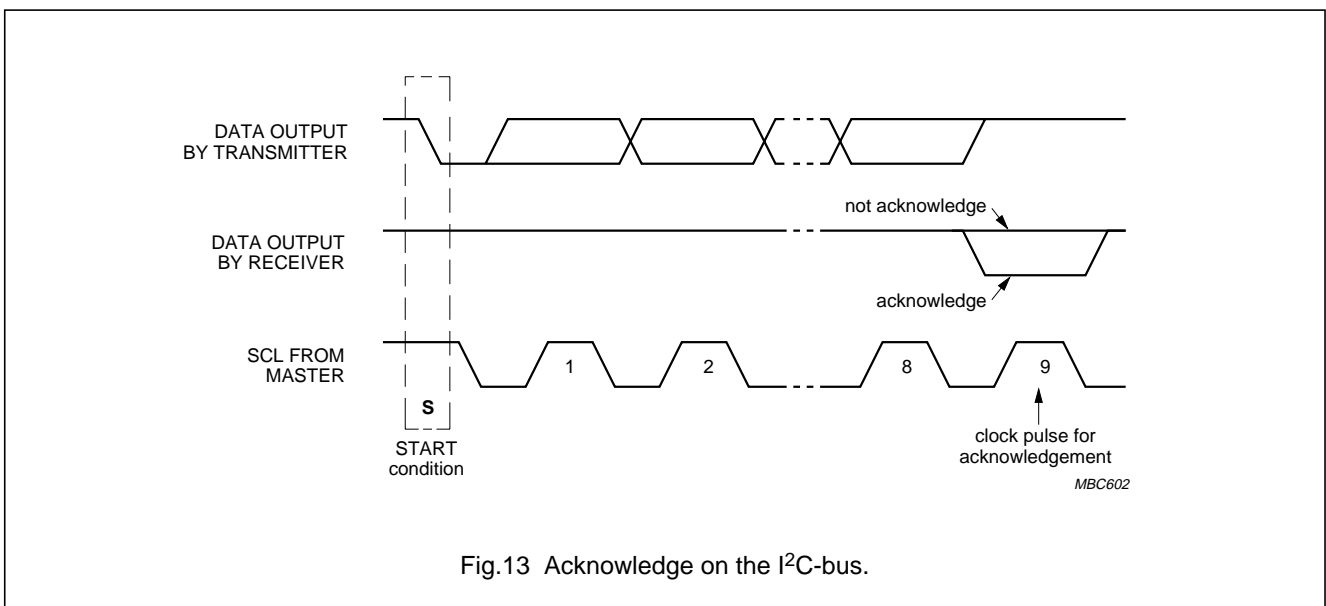
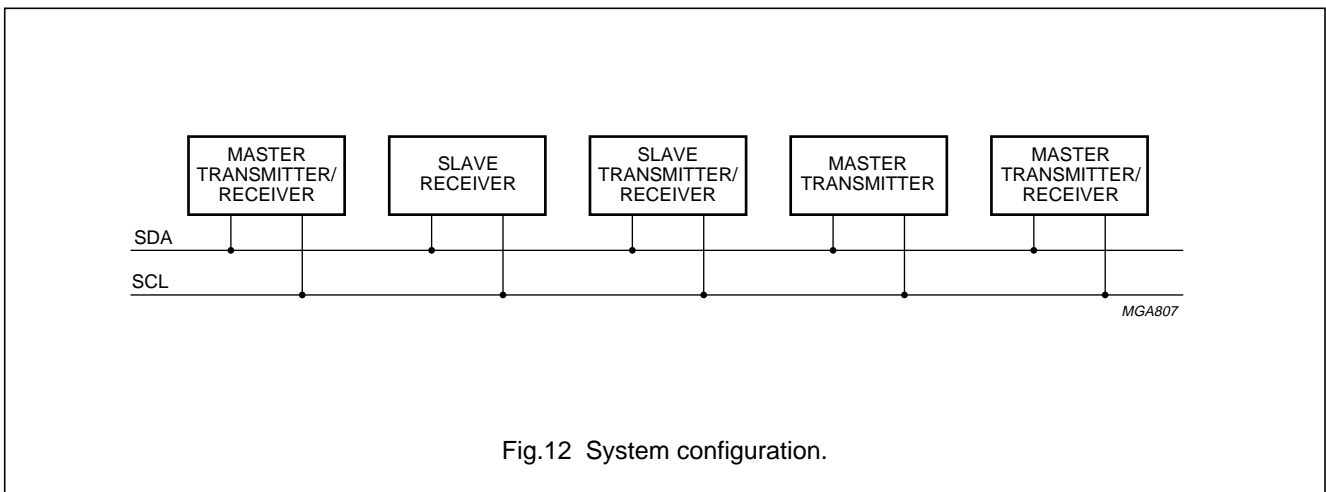
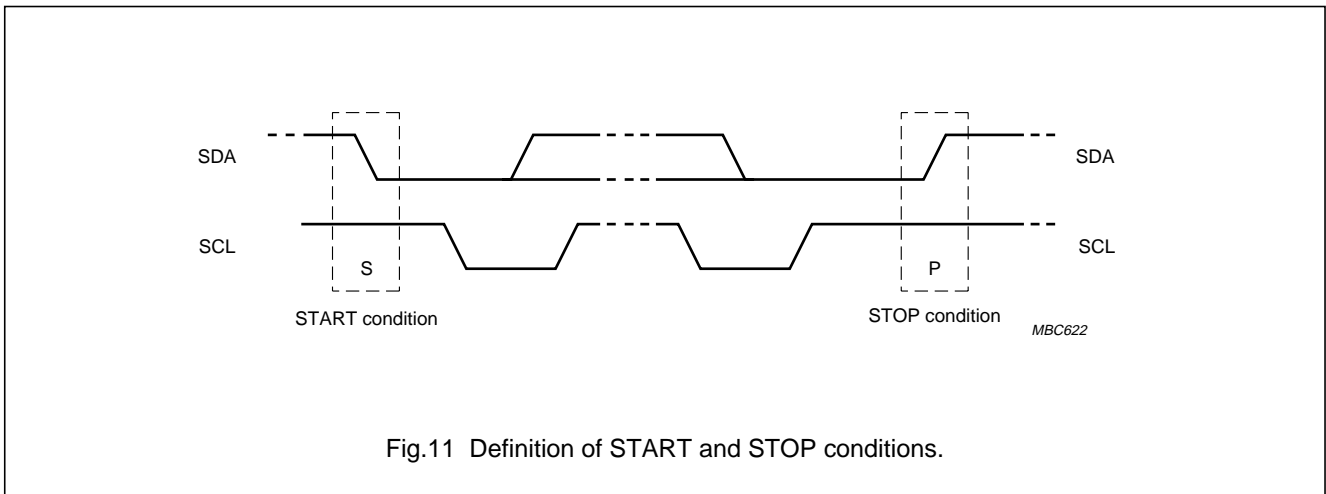

Fig.10 Bit transfer.

34 × 128 pixel matrix driver

PCF8531



34 × 128 pixel matrix driver

PCF8531

9.2 I²C-bus protocol

This driver does not support 'read'. The PCF8531 is a slave receiver. Therefore, it only responds when $R/\overline{W} = 0$ in the slave address byte.

Before any data is transmitted on the I²C-bus, the device that should respond is addressed first. Two 7-bit slave addresses (0111100 and 0111101) are reserved for the PCF8531. The least significant bit of the slave address is set by connecting the input SA0 to either logic 0 (V_{SS}) or logic 1 (V_{DD}).

The I²C-bus protocol is illustrated in Fig.14.

The sequence is initiated with a START condition (S) from the I²C-bus master, and is followed by the slave address. All slaves with the corresponding address acknowledge in parallel, all others ignore the I²C-bus transfer. After acknowledgement, one or more command words follow, which define the status of the addressed slaves. A command word consists of a control byte, which defines Co and RS, plus a data byte (see Fig.14 and Table 1).

The last control byte is tagged with a cleared most significant bit, the continuation bit Co. The control and data bytes are also acknowledged by all addressed slaves on the bus.

After the last control byte, depending on the RS bit setting, either a series of display data bytes or command data bytes may follow. If the RS bit was set to logic 1, these display bytes are stored in the display RAM at the address specified by the data pointer.

The data pointer is automatically updated and the data is directed to the intended PCF8531 device. If the RS bit of the last control byte was set to logic 0, these command bytes will be decoded and the setting of the device will be changed according to the received commands.

The acknowledgement after each byte is made only by the addressed PCF8531. At the end of the transmission, the I²C-bus master issues a STOP condition (P).

9.3 Command decoder

- Pairs of bytes; information in the second byte, the first byte determines whether information is display or instruction data
- Stream of information bytes after Co = 0; display or instruction data, depending on last RS (Register Selection).

The command decoder identifies command words that arrive on the I²C-bus. The most significant bit of a control byte is the continuation bit Co. If this bit is logic 1, it indicates that only one data byte (either command or RAM data) will follow. If this bit is logic 0, it indicates that a series of data bytes (either command or RAM data) may follow. The DB6 bit of a control byte is the RAM data/command bit RS. When this bit is at logic 1, it indicates that another RAM data byte will be transferred next. If the bit is at logic 0, it indicates that another command byte will be transferred next.

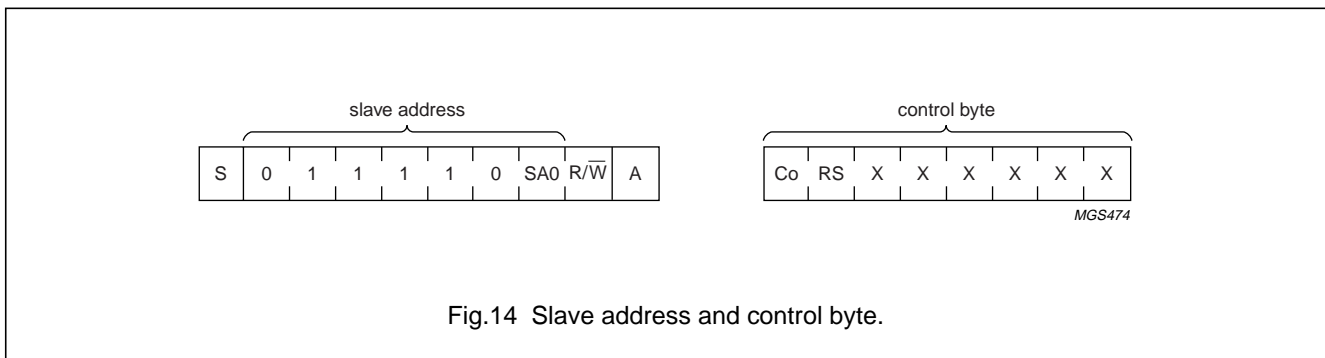

Fig.14 Slave address and control byte.

34 × 128 pixel matrix driver

PCF8531

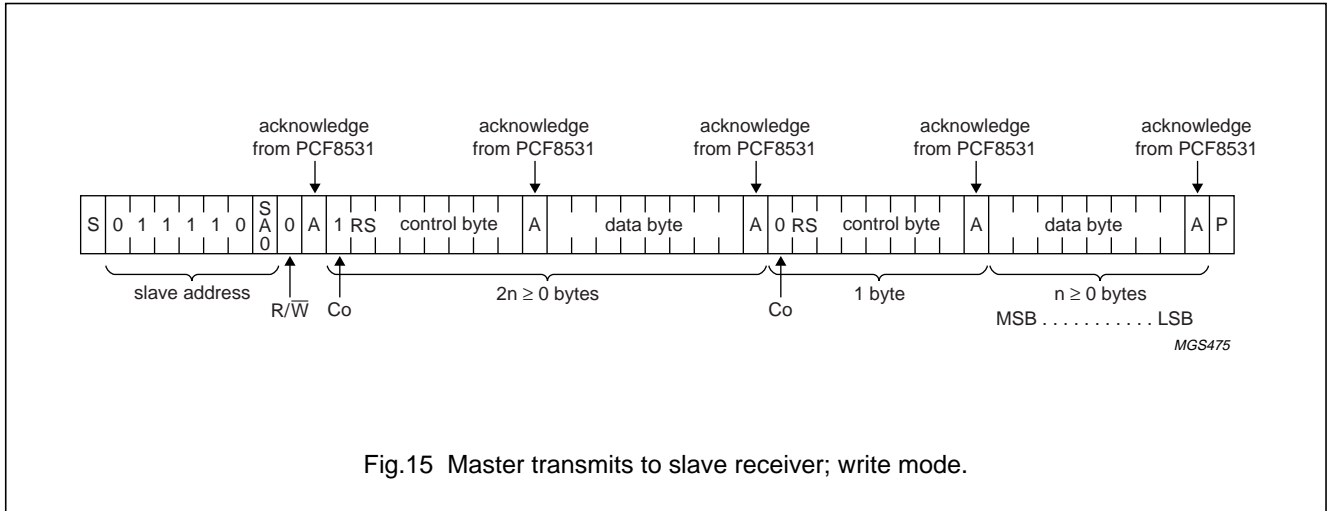

Fig.15 Master transmits to slave receiver; write mode.

10 LIMITING VALUES

In accordance with the Absolute Maximum Rating System (IEC 134); note 1.

SYMBOL	PARAMETER	MIN.	MAX.	UNIT
V _{DD1}	logic supply voltage	-0.5	+5.5	V
V _{DD2} , V _{DD3}	multiplier supply voltage	-0.5	+4.5	V
I _{DD}	supply current	-50	+50	mA
V _{LCD}	LCD supply voltage	-0.5	+9.0	V
I _{LCD}	LCD supply current	-50	+50	mA
I _{SS}	negative supply current	-50	+50	mA
V _I /V _O	input/output voltage (any input/output)	-0.5	V _{DD} + 0.5	V
I _I	DC input current	-10	+10	mA
I _O	DC output current	-10	+10	mA
P _{tot}	total power dissipation per package	-	300	mW
P/out	power dissipation per output	-	30	mW
T _{stg}	storage temperature	-65	+150	°C
T _j	junction temperature	-	150	°C

Note

- Parameters are valid over the operating temperature range unless otherwise specified. All voltages referenced to V_{SS} unless otherwise noted.

11 HANDLING

Inputs and outputs are protected against electrostatic discharge in normal handling. However, to be totally safe, it is recommended to take normal precautions appropriate to handling MOS devices (see "Handling MOS Devices").

34 × 128 pixel matrix driver

PCF8531

12 DC CHARACTERISTICS

$V_{DD1} = 1.8$ (1.9) to 5.5 V; V_{DD2} and $V_{DD3} = 2.5$ to 4.5 V; $V_{SS1,2} = 0$ V; V_{DD1} to $V_{DD3} \leq V_{LCD} \leq 9.0$ V;
 $T_{amb} = -40$ to $+85$ °C; unless otherwise specified.

SYMBOL	PARAMETER	CONDITIONS	MIN.	TYP.	MAX.	UNIT
Supplies						
V_{LCD}	LCD supply voltage	note 1	4.0	–	9.0	V
		icon mode; note 1	3.0	–	9.0	V
V_{DD1}	logic supply voltage		1.9	–	5.5	V
		$T_{amb} \geq -25$ °C	1.8	–	5.5	V
V_{DD2}, V_{DD3}	multiplier supply voltage	LCD voltage internally generated	2.5	–	4.5	V
I_{DD}	supply current	Power-down mode; internal V_{LCD}	–	2	10	μ A
		normal mode; internal V_{LCD} ; notes 2 and 3	–	170	350	μ A
		normal mode; external V_{LCD} ; note 2	–	10	50	μ A
I_{LCD}	LCD input current	normal mode; external V_{LCD} ; notes 2 and 4	–	25	100	μ A
		icon mode; external V_{LCD} ; notes 2 and 5	–	15	70	μ A
V_{POR}	Power-on reset level	note 6	0.9	1.2	1.6	V
Logic						
V_{IL}	LOW-level input voltage		V_{SS}	–	$0.3V_{DD}$	V
V_{IH}	HIGH-level input voltage		$0.7V_{DD}$	–	V_{DD}	V
I_{OL}	LOW-level output current (SDA)	$V_{OL} = 0.4$ V; $V_{DD} = 5$ V	3.0	–	–	mA
I_{LI}	input leakage current	$V_I = V_{DD}$ or V_{SS}	–1	–	+1	μ A
Column and row outputs						
$R_{O(col)}$	column output resistance C0 to C127	note 7	–	12	20	k Ω
$R_{O(row)}$	row output resistance R0 to R33	note 7	–	12	20	k Ω
$V_{bias(col)}$	bias tolerance C0 to C127		–100	0	+100	mV
$V_{bias(row)}$	bias tolerance R0 to R33		–100	0	+100	mV

34 × 128 pixel matrix driver

PCF8531

SYMBOL	PARAMETER	CONDITIONS	MIN.	TYP.	MAX.	UNIT
V_{LCD} generation						
V _{LCD(tol)}	LCD voltage tolerance, internal V _{LCD}	TC1 to TC7; note 8	–	–	±3.9	%
TC0	LCD voltage temperature coefficient 0	T _{amb} = –20 to +70 °C	–	0	–	%/°C
TC1	LCD voltage temperature coefficient 1	T _{amb} = –20 to +70 °C	–	–0.026	–	%/°C
TC2	LCD voltage temperature coefficient 2	T _{amb} = –20 to +70 °C	–	–0.039	–	%/°C
TC3	LCD voltage temperature coefficient 3	T _{amb} = –20 to +70 °C	–	–0.052	–	%/°C
TC4	LCD voltage temperature coefficient 4	T _{amb} = –20 to +70 °C	–	–0.078	–	%/°C
TC5	LCD voltage temperature coefficient 5	T _{amb} = –20 to +70 °C	–	–0.13	–	%/°C
TC6	LCD voltage temperature coefficient 6	T _{amb} = –20 to +70 °C	–	–0.19	–	%/°C
TC7	LCD voltage temperature coefficient 7	T _{amb} = –20 to +70 °C	–	–0.26	–	%/°C
T _{cut}	cut point temperature		–	27	–	°C

Notes

- As the programming range for the internally generated V_{LCD} allows values above the maximum allowed V_{LCD}, the user has to ensure, while setting the V_{OP} register and selecting the temperature compensation, that the V_{LCD} limit of maximum 9 V will never be exceeded under all conditions and including all tolerances.
- LCD outputs are open circuit, inputs at V_{DD} or V_{SS}; bus inactive.
- V_{DD1} to V_{DD3} = 2.85 V; V_{LCD} = 7.0 V; voltage multiplier = 3 × V_{DD}; f_{OSC} = 34 kHz.
- V_{DD1} to V_{DD3} = 2.75 V; V_{LCD} = 9.0 V; f_{OSC} = 34 kHz.
- V_{DD1} to V_{DD3} = 2.75 V; V_{LCD} = 3.5 V; f_{OSC} = 34 kHz.
- Resets all logic when V_{DD1} < V_{POR}.
- |I_{LOAD}| ≤ 50 μA; outputs tested one at a time.
- V_{LCD} ≤ 7.7 V.

34 × 128 pixel matrix driver

PCF8531

13 AC CHARACTERISTICS

$V_{DD1} = 1.8$ to 5.5 V; V_{DD2} and $V_{DD3} = 2.5$ to 4.5 V; V_{SS1} and $V_{SS2} = 0$ V; V_{DD1} to $V_{DD3} \leq V_{LCD} \leq 9.0$ V;
 $T_{amb} = -40$ to $+85$ °C; unless otherwise specified.

SYMBOL	PARAMETER	CONDITIONS	MIN.	TYP.	MAX.	UNIT
f_{frame}	LCD frame frequency (internal clock)	$V_{DD} = 3.0$ V; note 1	40	66	135	Hz
f_{OSC}	oscillator frequency (not available at any pin)		20	34	65	kHz
$f_{clk(ext)}$	external clock frequency		20	–	65	kHz
$t_{W(RESL)}$	reset LOW pulse width	note 2	300	–	–	ns
$t_{SU;RESL}$	reset LOW pulse set-up time after Power-on		–	–	30	μ s
Serial-bus interface; note 3						
f_{SCL}	SCL clock frequency		0	–	400	kHz
t_{SCLL}	SCL clock LOW period		1.3	–	–	μ s
t_{SCLH}	SCL clock HIGH period		0.6	–	–	μ s
$t_{SU;DAT}$	data set-up time		100	–	–	ns
$t_{HD;DAT}$	data hold time		0	–	0.9	μ s
t_r	SCL, SDA rise time	note 4	$20 + 0.1C_b$	–	300	ns
t_f	SCL, SDA fall time	note 4	$20 + 0.1C_b$	–	300	ns
C_b	capacitive load represented by each bus line		–	–	400	pF
$t_{SU;STA}$	set-up time for a repeated START condition		0.6	–	–	μ s
$t_{HD;STA}$	start condition hold time		0.6	–	–	μ s
$t_{SU;STO}$	set-up time for STOP condition		0.6	–	–	μ s
t_{SW}	tolerable spike width on bus		–	–	50	ns
t_{BUF}	bus free time between a STOP and START condition		1.3	–	–	μ s

Notes

- $f_{frame} = f_{clk(ext)}/480$; $f_{OSC}/480$.
- For $t_{W(RESL)} > 3$ ns a reset may be generated.
- All timing values are valid within the operating supply voltage and ambient temperature range and are referenced to V_{IL} and V_{IH} with an input voltage swing of V_{SS} to V_{DD} .
- C_b = total capacitance of one bus line in pF.

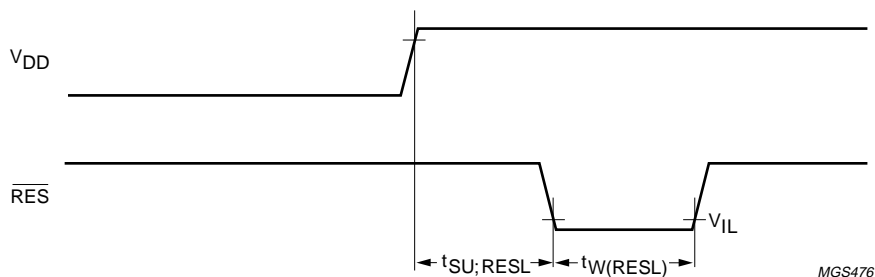

Fig.16 Reset timing.

34 × 128 pixel matrix driver

PCF8531

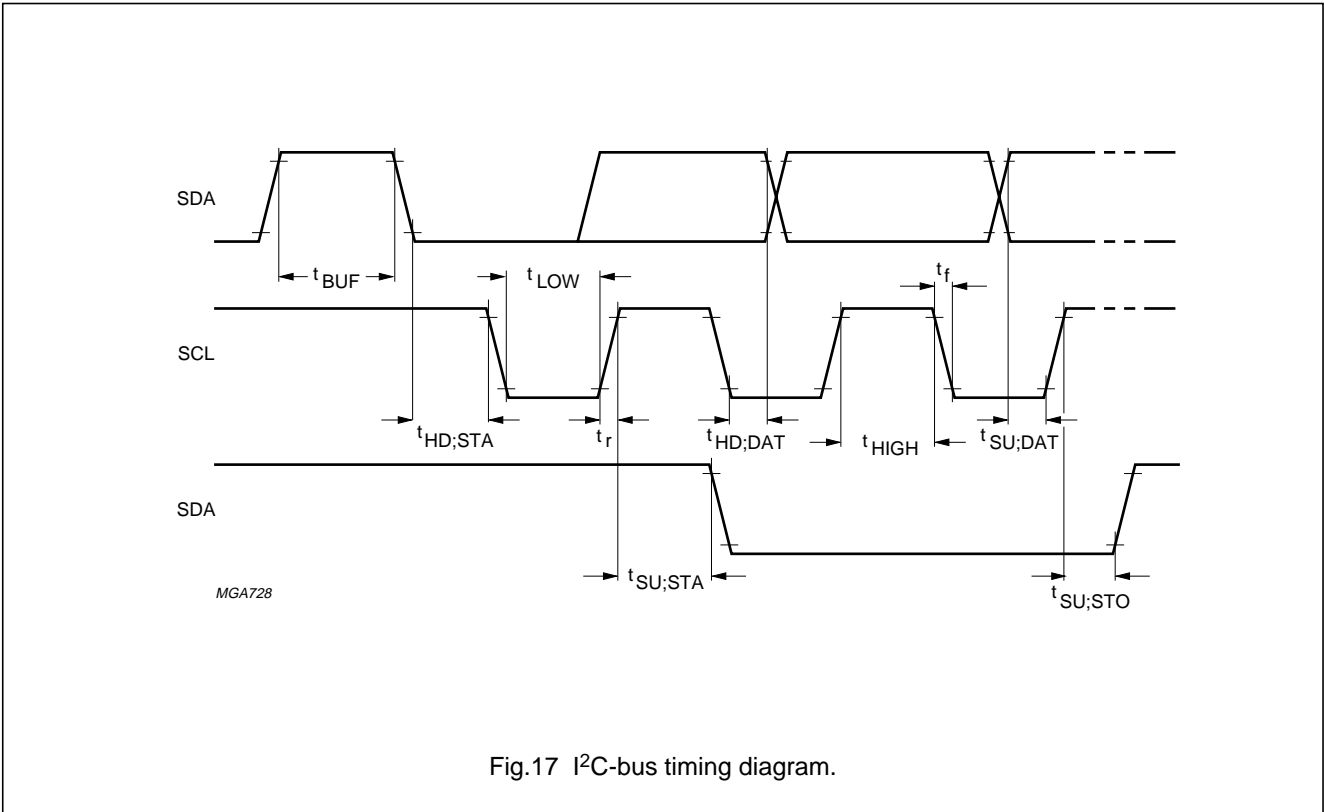

Fig.17 I²C-bus timing diagram.

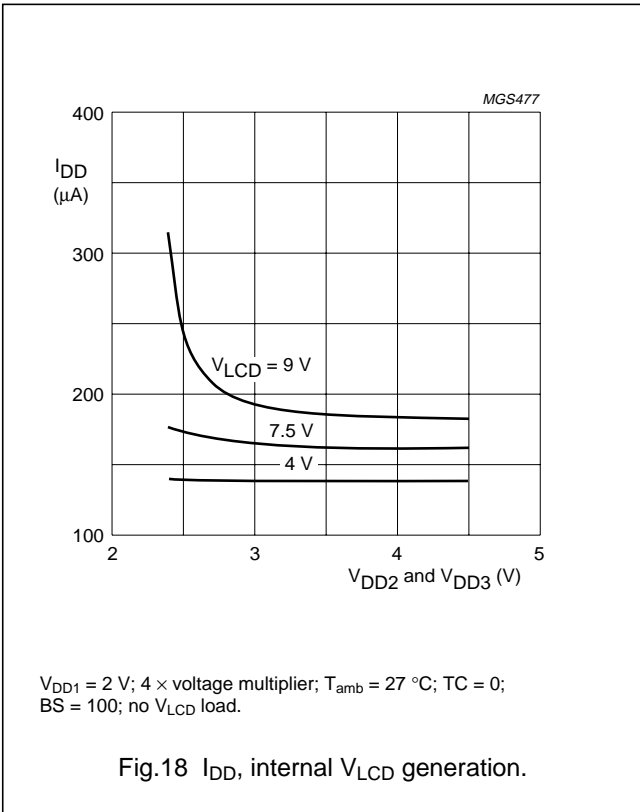

Fig.18 I_{DD} , internal V_{LCD} generation.

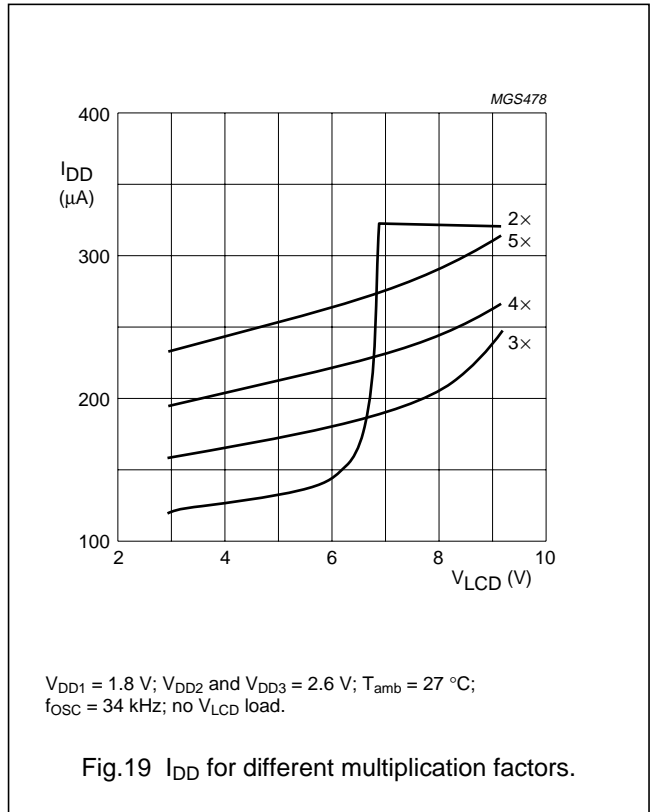
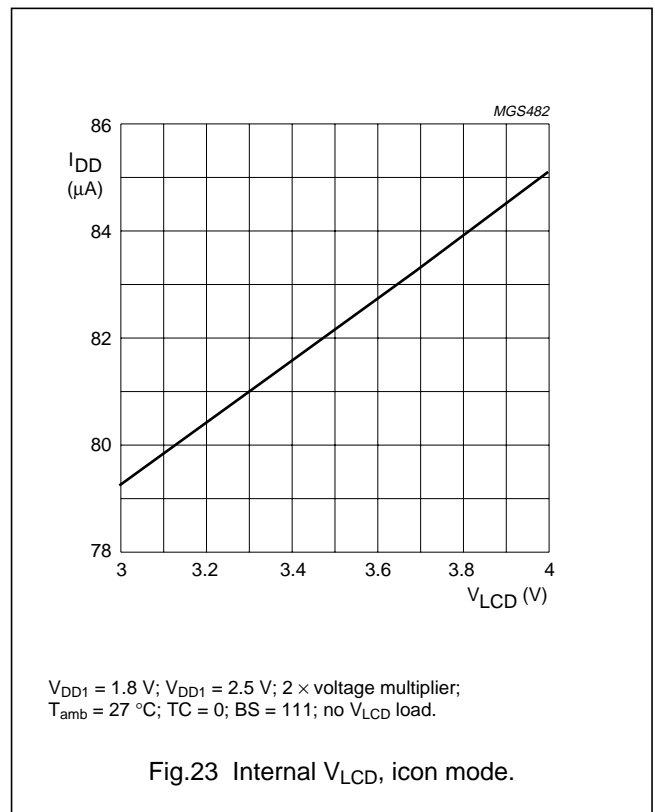
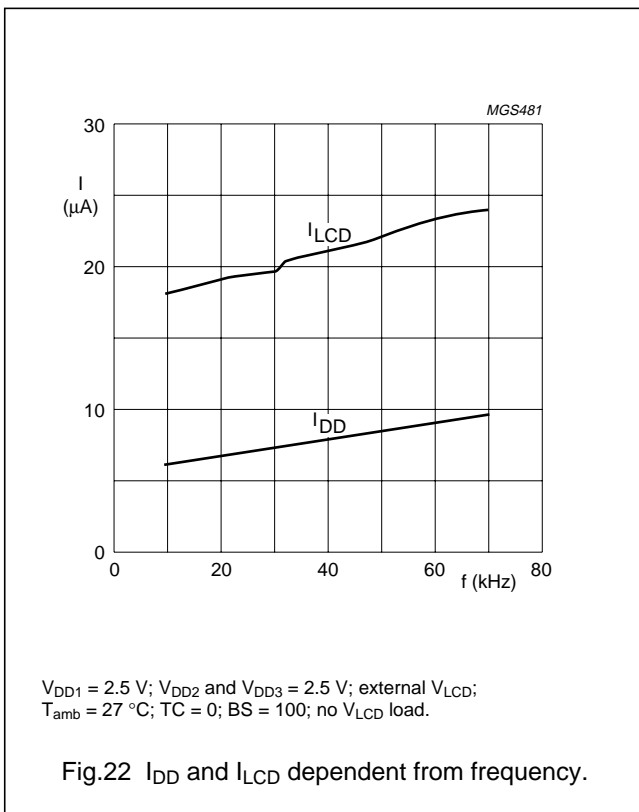
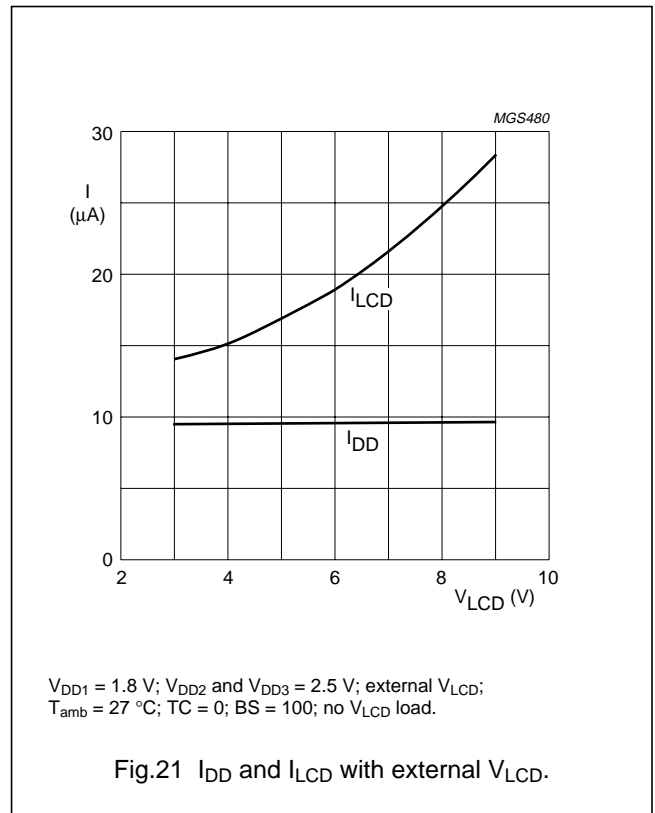
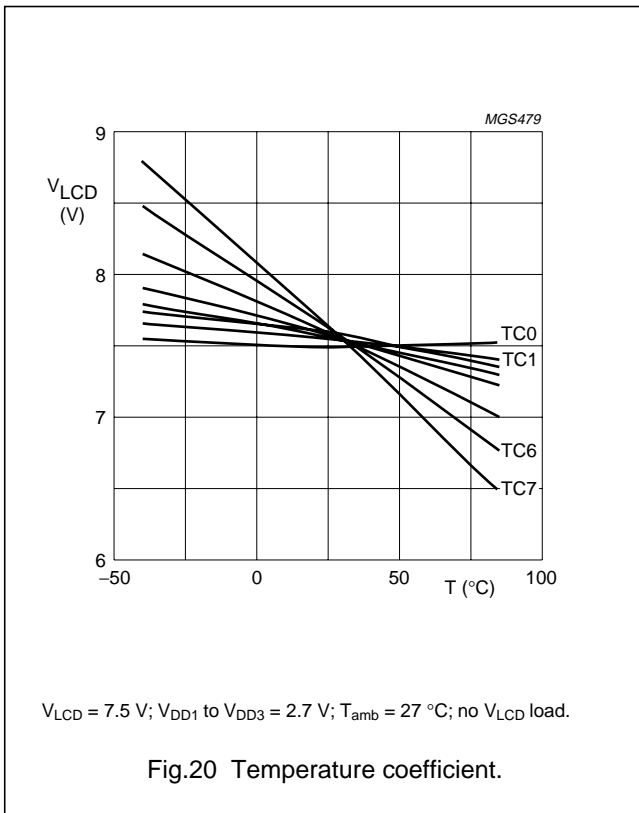

Fig.19 I_{DD} for different multiplication factors.

34 × 128 pixel matrix driver

PCF8531



34 × 128 pixel matrix driver

PCF8531

14 APPLICATION INFORMATION

Table 9 Programming example for PCF8531

STEP	SERIAL BUS BYTE								DISPLAY	OPERATION
	DB7	DB6	DB5	DB4	DB3	DB2	DB1	DB0		
1	0	1	1	1	1	0	SA0	0		start; slave address; R/W = 0
2	1	0	0	0	0	0	0	0		control byte; Co = 1; RS = 0
3	0	0	0	0	0	0	0	1		H[1:0] independent command; select function and RAM command page (H[1:0] = 00)
4	1	0	0	0	0	0	0	0		control byte; Co = 1; RS = 0
5	0	0	1	0	0	0	1	0		function and RAM command page PD = 0 and V = 1
6	1	0	0	0	0	0	0	0		control byte; Co = 1; RS = 0
7	0	0	0	0	1	0	0	1		function and RAM command page select display setting command page H[1:0] = 01
8	1	0	0	0	0	0	0	0		control byte; Co = 1; RS = 0
9	0	0	0	0	1	1	0	0		display setting command page; set normal mode (D = 1; IM = 0 and E = 0)
10	1	0	0	0	0	0	0	0		control byte; Co = 1; RS = 0
11	0	0	0	0	0	1	0	1		select Mux rate 1 : 34
12	1	0	0	0	0	0	0	0		control byte; Co = 1; RS = 0
13	0	0	0	0	0	0	0	1		H[2:0] independent command; select function and RAM command page H[1:0] = 00
14	1	0	0	0	0	0	0	0		control byte; Co = 1; RS = 0
15	0	0	0	0	1	0	1	0		function and RAM command page; select HV-gen command page H[1:0] = 10
16	1	0	0	0	0	0	0	0		control byte; Co = 1; RS = 0
17	0	0	0	0	1	0	1	1		HV-gen command page; select voltage multiplication factor 5 S[1:0] = 11
18	1	0	0	0	0	0	0	0		control byte; Co = 1; RS = 0
19	0	0	1	0	0	0	1	0		HV-gen command page; select temperature coefficient 2 TC[2:0] = 010
20	1	0	0	0	0	0	0	0		control byte; Co = 1; RS = 0

34 × 128 pixel matrix driver

PCF8531

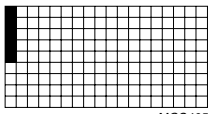
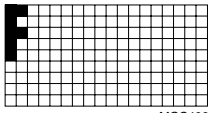
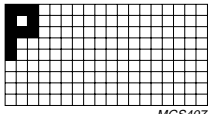
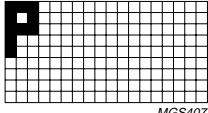
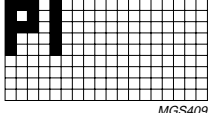
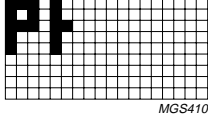
STEP	SERIAL BUS BYTE								DISPLAY	OPERATION
	DB7	DB6	DB5	DB4	DB3	DB2	DB1	DB0		
21	0	0	0	0	0	1	1	1		HV-gen command page; select high V _{LCD} programming range (PRS = 1); voltage multiplier off (HVE = 1)
22	1	0	0	0	0	0	0	0		control byte; Co = 1; RS = 0
23	1	0	1	0	0	0	0	0		HV-gen command page; set V _{LCD} = 7.71 V; V _{OP} [6:0] = 0100000
24	0	1	0	0	0	0	0	0		control byte; Co = 0; RS = 1
25	0	0	0	1	1	1	1	1	 <small>MGS405</small>	data write; Y and X are initialized to 0 by default, so they are not set here
26	0	0	0	0	0	1	0	1	 <small>MGS406</small>	data write
27	0	0	0	0	0	1	1	1	 <small>MGS407</small>	data write
28	0	0	0	0	0	0	0	0	 <small>MGS407</small>	data write
29	0	0	0	1	1	1	1	1	 <small>MGS409</small>	data write
30	0	0	0	0	0	1	0	0	 <small>MGS410</small>	data write

34 × 128 pixel matrix driver

PCF8531

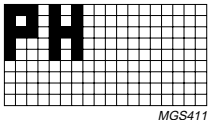
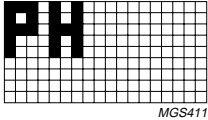
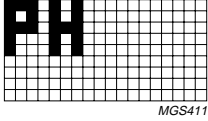
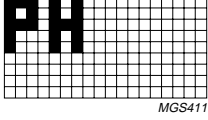
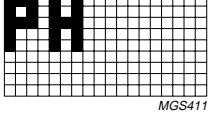
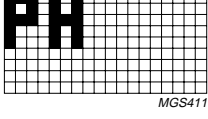
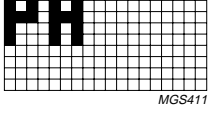
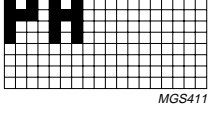
STEP	SERIAL BUS BYTE								DISPLAY	OPERATION
	DB7	DB6	DB5	DB4	DB3	DB2	DB1	DB0		
31	0	0	0	1	1	1	1	1		data write; last data and stop transmission
32	0	1	1	1	1	0	SA0	0		repeated start; slave address; $R/\bar{W} = 0$
33	1	0	0	0	0	0	0	0		control byte; $Co = 1$; $RS = 0$
34	0	0	0	0	0	0	0	1		H[1:0] independent command; select function and RAM command page H[1:0] = 00
35	1	0	0	0	0	0	0	0		control byte; $Co = 1$; $RS = 0$
36	0	0	0	0	1	0	0	1		function and RAM command page; select display setting command page H[1:0] = 01
37	1	0	0	0	0	0	0	0		control byte; $Co = 1$; $RS = 0$
38	0	0	0	0	0	0	0	1		H[1:0] independent command; select function and RAM command page H[1:0] = 00

34 × 128 pixel matrix driver

PCF8531

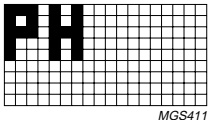
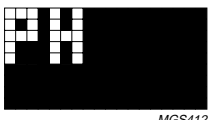
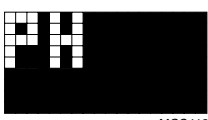
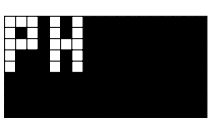
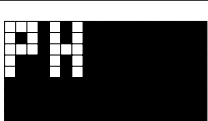
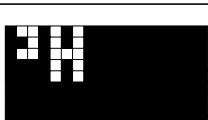
STEP	SERIAL BUS BYTE								DISPLAY	OPERATION
	DB7	DB6	DB5	DB4	DB3	DB2	DB1	DB0		
39	1	0	0	0	0	0	0	0	 <i>MGS411</i>	control byte; Co = 1; RS = 0
40	0	0	0	0	1	1	0	1	 <i>MGS412</i>	display control; set inverse video mode (D = 1; E = 1 and IM = 0)
41	1	0	0	0	0	0	0	0	 <i>MGS412</i>	control byte; Co = 1; RS = 0
42	1	0	0	0	0	0	0	0	 <i>MGS412</i>	set X address of RAM; set address to '0000000'
43	0	1	0	0	0	0	0	0	 <i>MGS412</i>	control byte; Co = 0; RS = 1
44	0	0	0	0	0	0	0	0	 <i>MGS414</i>	data write

The pinning of the PCF8531 is optimized for single plane wiring e.g. for chip-on-glass display modules. Display size: 34 × 128 pixels.

34 × 128 pixel matrix driver

PCF8531

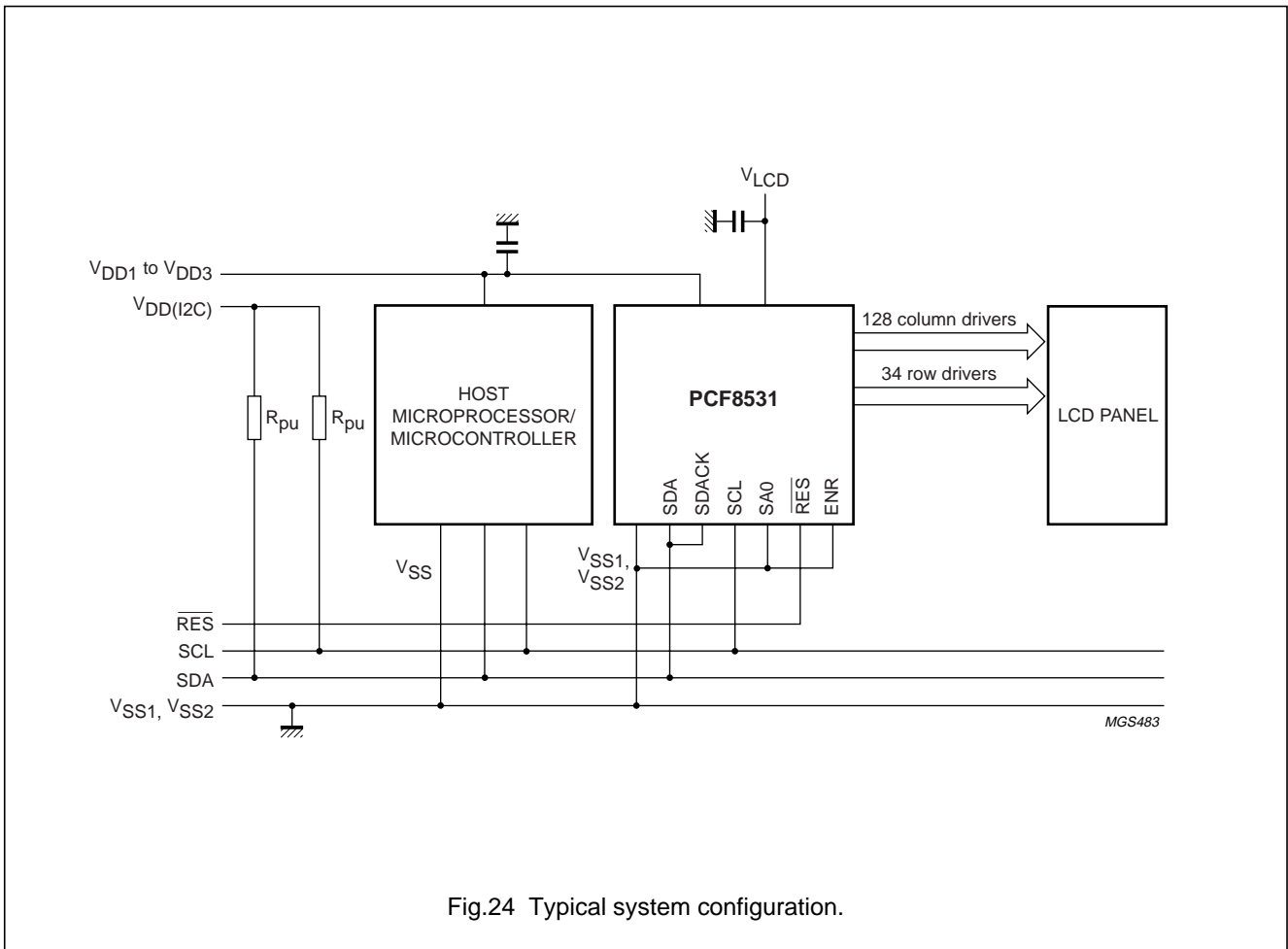
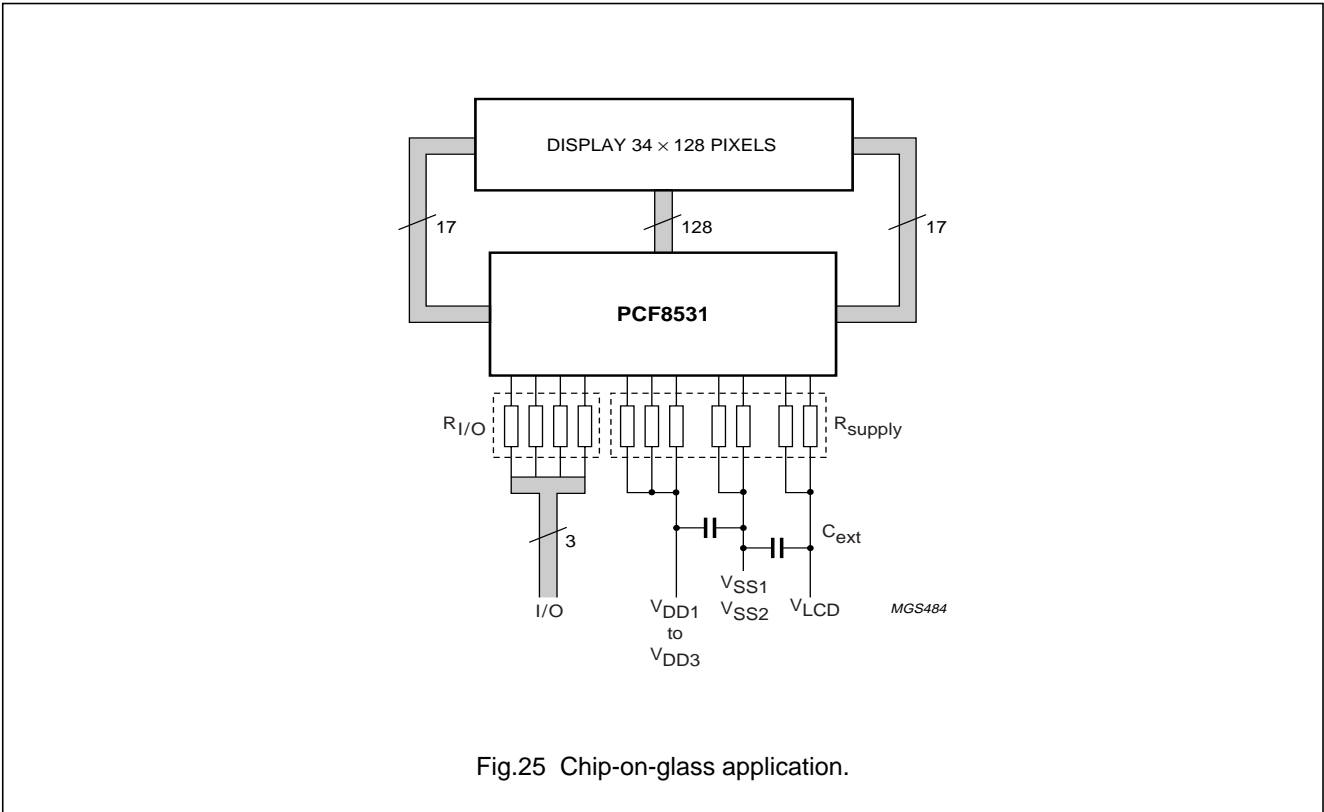

Fig.24 Typical system configuration.

The host microprocessor/microcontroller and the PCF8531 are both connected to the I²C-bus. The SDA and SCL lines must be connected to the positive power supply via pull-up resistors. The internal oscillator requires no external components. The appropriate intermediate biasing voltage for the multiplexed LCD waveforms are generated on-chip. The only other connections required to complete the system are to the power supplies (V_{DD} , V_{SS} and V_{LCD}) and suitable capacitors for decoupling V_{LCD} and V_{DD} .

34 × 128 pixel matrix driver

PCF8531



The required minimum values for the external capacitors in an application with the PCF8531 are as follows:

- $C_{ext} = 100\text{ nF}$ for V_{LCD} and V_{SS1} and V_{SS2} , and $C_{ext} = 470\text{ nF}$ for V_{DD1} to V_{DD3} and V_{SS1} and V_{SS2}
- Higher capacitor values are recommended for ripple reduction
- For COG applications, the recommended ITO track resistance is to be minimized for the I/O and supply connections. Optimized values for these tracks are below $50\ \Omega$ for the supply (R_{supply}) and below $100\ \Omega$ for the I/O connections ($R_{I/O}$).
- To reduce the sensitivity of the reset to ESD/EMC disturbances for a chip-on-glass application, it is strongly recommended to implement a series input resistance in the reset line (recommended minimum value $8\text{ k}\Omega$) on the glass (ITO). If the reset input is not used, it should be connected to V_{DD1} using a short connection.

34 × 128 pixel matrix driver

PCF8531

15 BONDING PAD LOCATIONS

Table 10 Bonding pad locations

All x and y coordinates are referenced to the centre of the chip (dimensions in μm ; see Fig.28).

SYMBOL	PAD	x	y
dummy	1	+5973.6	-821.7
dummy	2	+5969.5	+823.4
dummy	3	+5899.5	+823.4
dummy	4	+5829.5	+823.4
dummy	5	+5479.5	+823.4
dummy	6	+5409.5	+823.4
dummy	7	+5059.5	+823.4
dummy	8	+4989.5	+823.4
dummy	9	+4639.5	+823.4
dummy	10	+4569.5	+823.4
dummy	11	+4219.5	+823.4
dummy	12	+4149.5	+823.4
dummy	13	+3799.5	+823.4
dummy	14	+3729.5	+823.4
OSC	15	+3449.5	+823.4
V _{LCDSENSE}	16	+3169.5	+823.4
V _{LCDOUT}	17	+3099.5	+823.4
V _{LCDOUT}	18	+3029.5	+823.4
V _{LCDOUT}	19	+2959.5	+823.4
V _{LCDOUT}	20	+2889.5	+823.4
V _{LCDOUT}	21	+2819.5	+823.4
V _{LCDOUT}	22	+2749.5	+823.4
V _{LCDOUT}	23	+2679.5	+823.4
V _{LCDIN}	24	+2539.5	+823.4
V _{LCDIN}	25	+2469.5	+823.4
V _{LCDIN}	26	+2399.5	+823.4
V _{LCDIN}	27	+2329.5	+823.4
V _{LCDIN}	28	+2259.5	+823.4
V _{LCDIN}	29	+2189.5	+823.4
V _{LCDIN}	30	+2119.5	+823.4
RES	31	+1979.5	+823.4
V _{DD3}	32	+1699.5	+823.4
V _{DD3}	33	+1629.5	+823.4
V _{DD3}	34	+1559.5	+823.4
V _{DD2}	35	+1279.5	+823.4
V _{DD2}	36	+1209.5	+823.4
V _{DD2}	37	+1139.5	+823.4

SYMBOL	PAD	x	y
V _{DD2}	38	+1069.5	+823.4
V _{DD2}	39	+999.5	+823.4
V _{DD2}	40	+929.5	+823.4
V _{DD2}	41	+859.5	+823.4
V _{DD2}	42	+789.5	+823.4
V _{DD1}	43	+649.5	+823.4
V _{DD1}	44	+579.5	+823.4
V _{DD1}	45	+509.5	+823.4
V _{DD1}	46	+439.5	+823.4
V _{DD1}	47	+369.5	+823.4
V _{DD1}	48	+299.5	+823.4
V _{DD1}	49	+229.5	+823.4
SDA	50	+19.5	+823.4
SDA	51	-50.5	+823.4
SDACK	52	-400.5	+823.4
dummy	53	-750.5	+823.4
SA0	54	-820.5	+823.4
ENR	55	-1100.5	+823.4
T4	56	-1380.5	+823.4
V _{SS2}	57	-1660.5	+823.4
V _{SS2}	58	-1730.5	+823.4
V _{SS2}	59	-1800.5	+823.4
V _{SS2}	60	-1870.5	+823.4
V _{SS2}	61	-1940.5	+823.4
V _{SS2}	62	-2010.5	+823.4
V _{SS2}	63	-2080.5	+823.4
V _{SS1}	64	-2220.5	+823.4
V _{SS1}	65	-2290.5	+823.4
V _{SS1}	66	-2360.5	+823.4
V _{SS1}	67	-2430.5	+823.4
V _{SS1}	68	-2500.5	+823.4
V _{SS1}	69	-2570.5	+823.4
V _{SS1}	70	-2640.5	+823.4
T3	71	-2780.5	+823.4
T1	72	-3060.5	+823.4
SCL	73	-3410.5	+823.4
SCL	74	-3480.5	+823.4
dummy	75	-3830.5	+823.4
dummy	76	-4180.5	+823.4
dummy	77	-4530.5	+823.4
T2	78	-4600.5	+823.4

34 × 128 pixel matrix driver

PCF8531

SYMBOL	PAD	x	y
dummy	79	-4880.5	+823.4
dummy	80	-4950.5	+823.4
dummy	81	-5230.5	+823.4
dummy	82	-5300.5	+823.4
dummy	83	-5650.5	+823.4
dummy	84	-5720.5	+823.4
dummy	85	-5930.5	+823.4
dummy	86	-5926.4	-821.7
R0	87	-5786.4	-821.7
R2	88	-5716.4	-821.7
R4	89	-5646.4	-821.7
R6	90	-5576.4	-821.7
R8	91	-5506.4	-821.7
R10	92	-5436.4	-821.7
R12	93	-5366.4	-821.7
R14	94	-5296.4	-821.7
R16	95	-5226.4	-821.7
R18	96	-5156.4	-821.7
R20	97	-5086.4	-821.7
R22	98	-5016.4	-821.7
R24	99	-4946.4	-821.7
R26	100	-4876.4	-821.7
R28	101	-4806.4	-821.7
R30	102	-4736.4	-821.7
R32	103	-4666.4	-821.7
C0	104	-4526.4	-821.7
C1	105	-4456.4	-821.7
C2	106	-4386.4	-821.7
C3	107	-4316.4	-821.7
C4	108	-4246.4	-821.7
C5	109	-4176.4	-821.7
C6	110	-4106.4	-821.7
C7	111	-4036.4	-821.7
C8	112	-3966.4	-821.7
C9	113	-3896.4	-821.7
C10	114	-3826.4	-821.7
C11	115	-3756.4	-821.7
C12	116	-3686.4	-821.7
C13	117	-3616.4	-821.7
C14	118	-3546.4	-821.7
C15	119	-3476.4	-821.7

SYMBOL	PAD	x	y
C16	120	-3406.4	-821.7
C17	121	-3336.4	-821.7
C18	122	-3266.4	-821.7
C19	123	-3196.4	-821.7
C20	124	-3126.4	-821.7
C21	125	-3056.4	-821.7
C22	126	-2986.4	-821.7
C23	127	-2916.4	-821.7
C24	128	-2846.4	-821.7
C25	129	-2776.4	-821.7
C26	130	-2706.4	-821.7
C27	131	-2636.4	-821.7
C28	132	-2566.4	-821.7
C29	133	-2496.4	-821.7
C30	134	-2426.4	-821.7
C31	135	-2356.4	-821.7
C32	136	-2286.4	-821.7
C33	137	-2216.4	-821.7
C34	138	-2146.4	-821.7
C35	139	-2076.4	-821.7
C36	140	-2006.4	-821.7
C37	141	-1936.4	-821.7
C38	142	-1866.4	-821.7
C39	143	-1796.4	-821.7
C40	144	-1726.4	-821.7
C41	145	-1656.4	-821.7
C42	146	-1586.4	-821.7
C43	147	-1516.4	-821.7
C44	148	-1446.4	-821.7
C45	149	-1376.4	-821.7
C46	150	-1306.4	-821.7
C47	151	-1236.4	-821.7
C48	152	-1166.4	-821.7
C49	153	-1096.4	-821.7
C50	154	-1026.4	-821.7
C51	155	-956.4	-821.7
C52	156	-886.4	-821.7
C53	157	-816.4	-821.7
C54	158	-746.4	-821.7
C55	159	-676.4	-821.7
C56	160	-606.4	-821.7

34 × 128 pixel matrix driver

PCF8531

SYMBOL	PAD	x	y
C57	161	-466.4	-821.7
C58	162	-396.4	-821.7
C59	163	-326.4	-821.7
C60	164	-256.4	-821.7
C61	165	-186.4	-821.7
C62	166	-116.4	-821.7
C63	167	-46.4	-821.7
C64	168	+93.6	-821.7
C65	169	+163.6	-821.7
C66	170	+233.6	-821.7
C67	171	+303.6	-821.7
C68	172	+373.6	-821.7
C69	173	+443.6	-821.7
C70	174	+513.6	-821.7
C71	175	+583.6	-821.7
C72	176	+653.6	-821.7
C73	177	+723.6	-821.7
C74	178	+793.6	-821.7
C75	179	+863.6	-821.7
C76	180	+933.6	-821.7
C77	181	+1003.6	-821.7
C78	182	+1073.6	-821.7
C79	183	+1143.6	-821.7
C80	184	+1213.6	-821.7
C81	185	+1283.6	-821.7
C82	186	+1353.6	-821.7
C83	187	+1423.6	-821.7
C84	188	+1493.6	-821.7
C85	189	+1563.6	-821.7
C86	190	+1633.6	-821.7
C87	191	+1703.6	-821.7
C88	192	+1773.6	-821.7
C89	193	+1843.6	-821.7
C90	194	+1913.6	-821.7
C91	195	+1983.6	-821.7
C92	196	+2053.6	-821.7
C93	197	+2123.6	-821.7
C94	198	+2193.6	-821.7
C95	199	+2263.6	-821.7
C96	200	+2403.6	-821.7
C97	201	+2473.6	-821.7

SYMBOL	PAD	x	y
C98	202	+2543.6	-821.7
C99	203	+2613.6	-821.7
C100	204	+2683.6	-821.7
C101	205	+2753.6	-821.7
C102	206	+2823.6	-821.7
C103	207	+2893.6	-821.7
C104	208	+2963.6	-821.7
C105	209	+3033.6	-821.7
C106	210	+3103.6	-821.7
C107	211	+3173.6	-821.7
C108	212	+3243.6	-821.7
C109	213	+3313.6	-821.7
C110	214	+3383.6	-821.7
C111	215	+3453.6	-821.7
C112	216	+3523.6	-821.7
C113	217	+3593.6	-821.7
C114	218	+3663.6	-821.7
C115	219	+3733.6	-821.7
C116	220	+3803.6	-821.7
C117	221	+3873.6	-821.7
C118	222	+3943.6	-821.7
C119	223	+4013.6	-821.7
C120	224	+4083.6	-821.7
C121	225	+4153.6	-821.7
C122	226	+4223.6	-821.7
C123	227	+4293.6	-821.7
C124	228	+4363.6	-821.7
C125	229	+4433.6	-821.7
C126	230	+4503.6	-821.7
C127	231	+4573.6	-821.7
R33	232	+4713.6	-821.7
R31	233	+4783.6	-821.7
R29	234	+4853.6	-821.7
R27	235	+4923.6	-821.7
R25	236	+4993.6	-821.7
R23	237	+5063.6	-821.7
R21	238	+5133.6	-821.7
R19	239	+5203.6	-821.7
R17	240	+5343.6	-821.7
R15	241	+5413.6	-821.7
R13	242	+5483.6	-821.7

34 × 128 pixel matrix driver

PCF8531

SYMBOL	PAD	x	y
R11	243	+5553.6	-821.7
R9	244	+5623.6	-821.7
R7	245	+5693.6	-821.7
R5	246	+5763.6	-821.7
R3	247	+5833.6	-821.7
R1	248	+5903.6	-821.7

Table 11 Bonding pads

PAD	SIZE	UNIT
Pad pitch	min. 70	μm
Pad size; Al	62 × 100	μm
Bump dimensions	50 × 90 × 17.5 (±5)	μm
Wafer thickness (excluding bumps)	381	μm

Table 12 Alignment marks

MARKS	x	y
C1	-5402.0	+823.1
C2	+5292.4	+823.4
F	+5890.3	+401.9
Circle 1	-5543.0	+798.4
Circle 2	+5637.4	+798.4

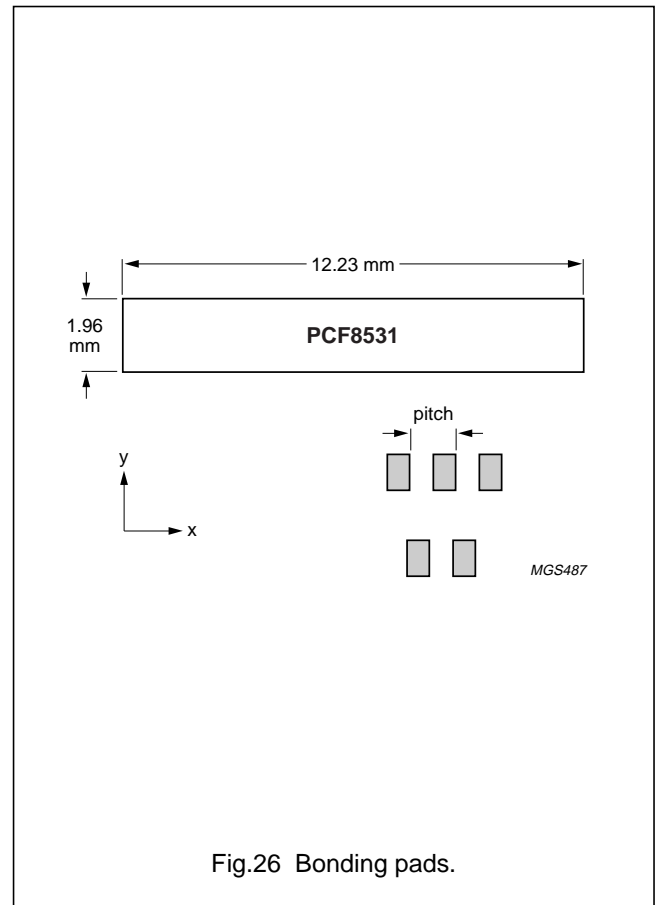

Fig.26 Bonding pads.

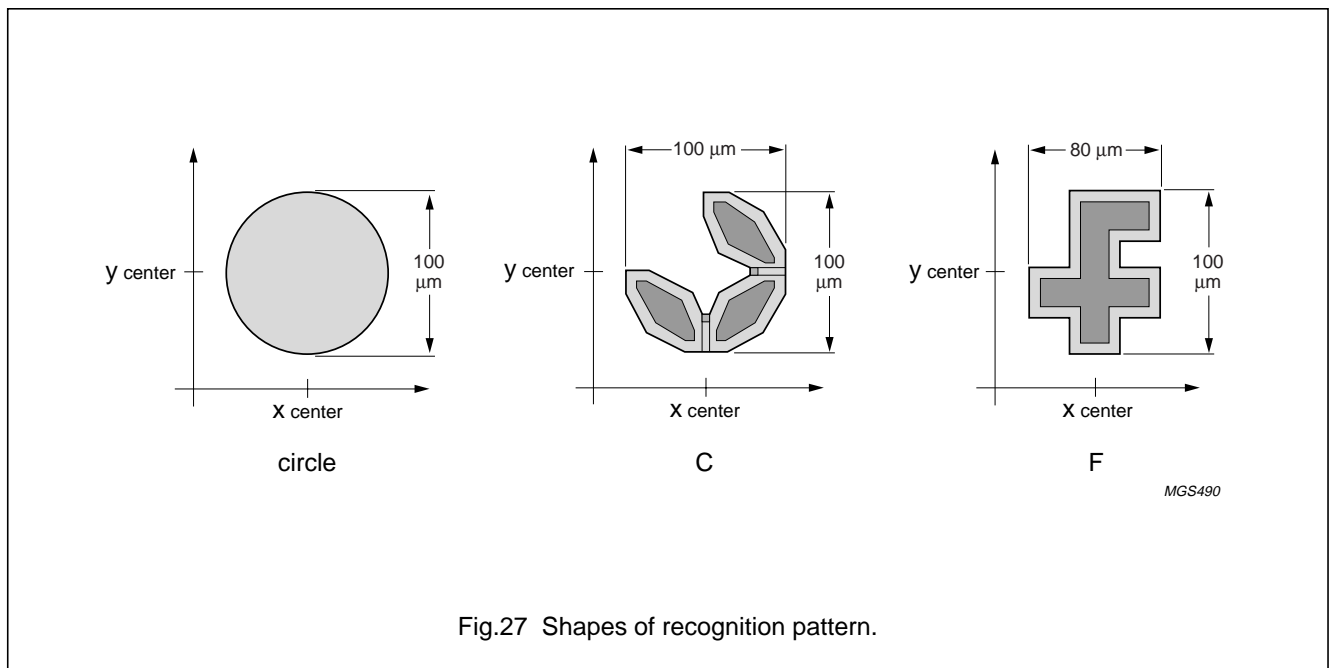
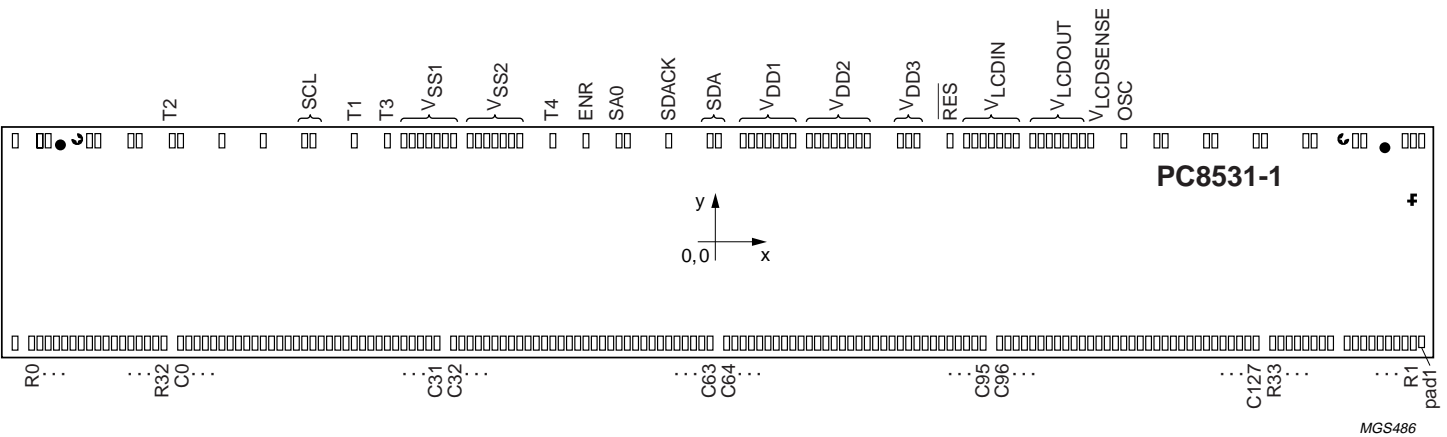

Fig.27 Shapes of recognition pattern.

34 × 128 pixel matrix driver

PCF8531



The positioning of the bonding pads is not to scale.

Fig.28 Bonding pad location.

34 × 128 pixel matrix driver

PCF8531

16 DEVICE PROTECTION DIAGRAM

For all diagrams: the maximum forward current is 5 mA and the maximum reverse voltage is 5 V.

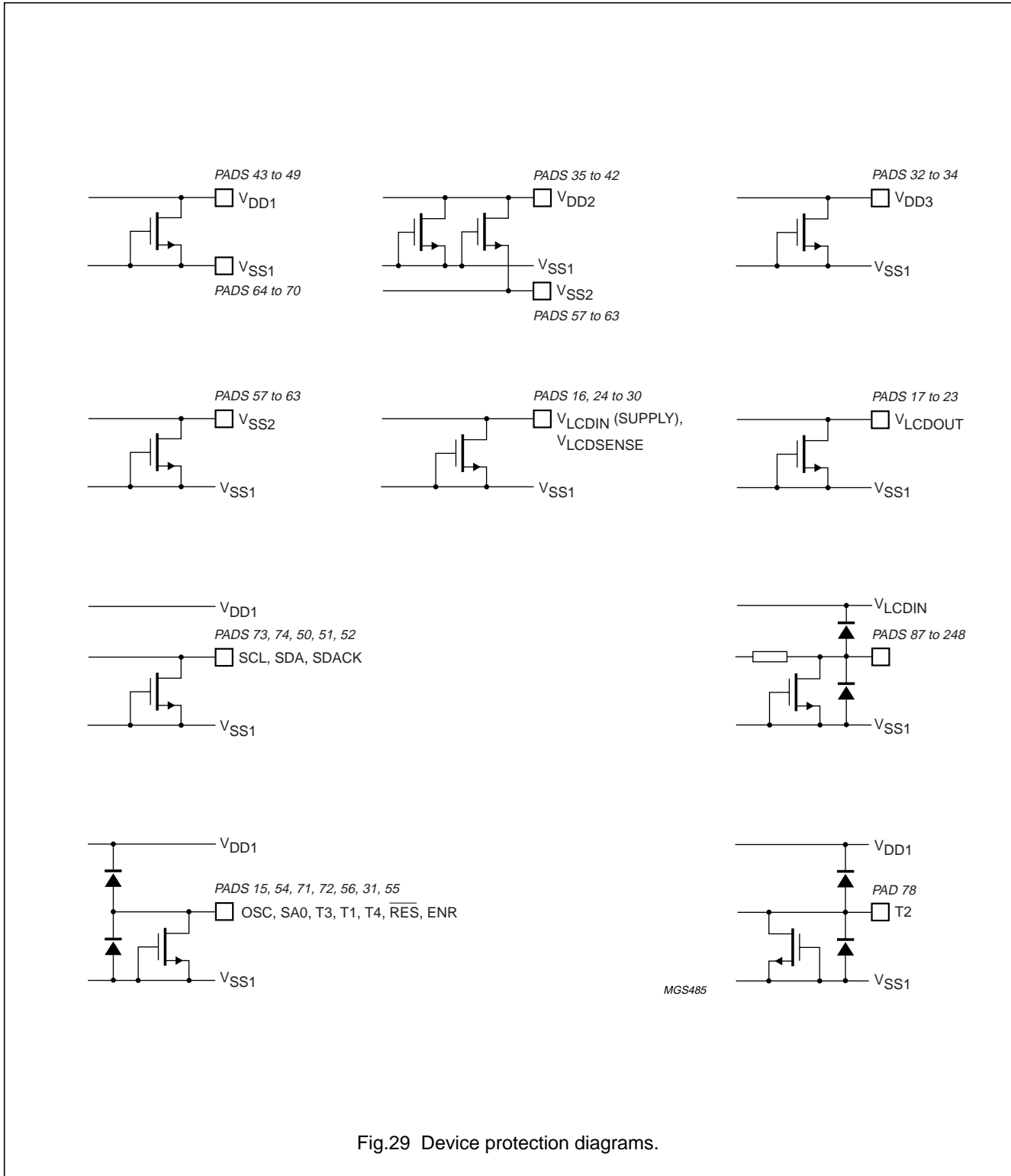

Fig.29 Device protection diagrams.

34 × 128 pixel matrix driver

PCF8531

17 TRAY INFORMATION

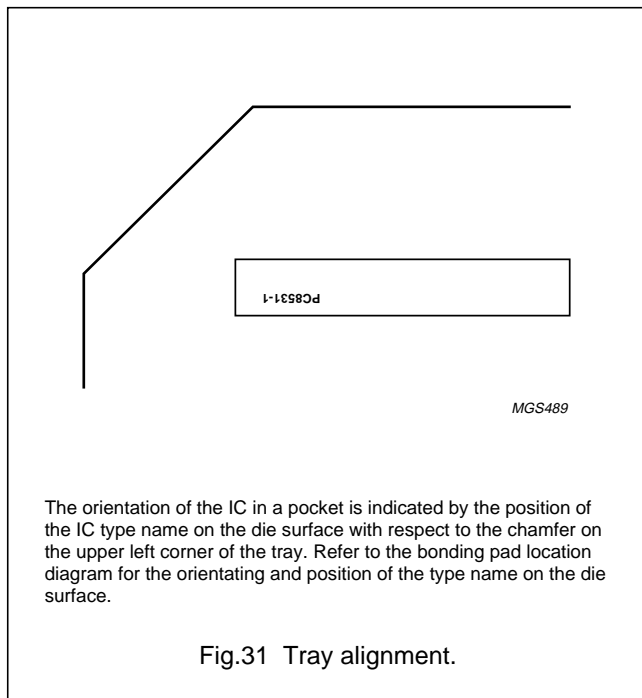
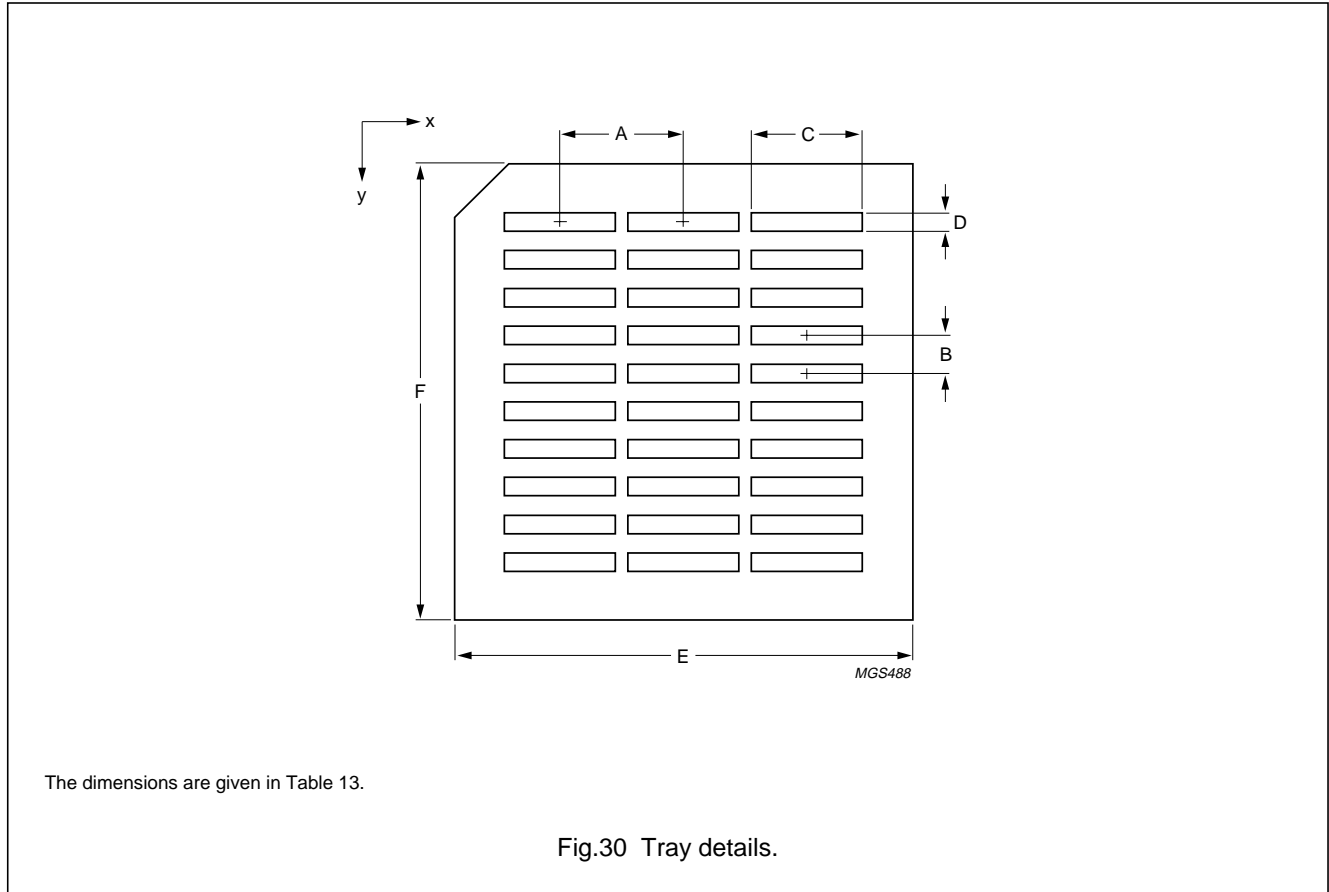

Table 13 Dimensions

DIM.	DESCRIPTION	VALUE
A	pocket pitch; x direction	13.72 mm
B	pocket pitch; y direction	4.17 mm
C	pocket width; x direction	12.34 mm
D	pocket width; y direction	2.05 mm
E	tray width; x direction	50.8 mm
F	tray width; y direction	50.8 mm
x	number of pockets in x direction	3
y	number of pockets in y direction	10

34 × 128 pixel matrix driver

PCF8531

18 DEFINITIONS

Data sheet status	
Objective specification	This data sheet contains target or goal specifications for product development.
Preliminary specification	This data sheet contains preliminary data; supplementary data may be published later.
Product specification	This data sheet contains final product specifications.
Limiting values	
Limiting values given are in accordance with the Absolute Maximum Rating System (IEC 134). Stress above one or more of the limiting values may cause permanent damage to the device. These are stress ratings only and operation of the device at these or at any other conditions above those given in the Characteristics sections of the specification is not implied. Exposure to limiting values for extended periods may affect device reliability.	
Application information	
Where application information is given, it is advisory and does not form part of the specification.	

19 LIFE SUPPORT APPLICATIONS

These products are not designed for use in life support appliances, devices, or systems where malfunction of these products can reasonably be expected to result in personal injury. Philips customers using or selling these products for use in such applications do so at their own risk and agree to fully indemnify Philips for any damages resulting from such improper use or sale.

20 PURCHASE OF PHILIPS I²C COMPONENTS

Purchase of Philips I²C components conveys a license under the Philips' I²C patent to use the components in the I²C system provided the system conforms to the I²C specification defined by Philips. This specification can be ordered using the code 9398 393 40011.

34 × 128 pixel matrix driver

PCF8531

NOTES

34 × 128 pixel matrix driver

PCF8531

NOTES

34 × 128 pixel matrix driver

PCF8531

NOTES

Philips Semiconductors – a worldwide company

Argentina: see South America

Australia: 3 Figtree Drive, HOMEBUSH, NSW 2140,
Tel. +61 2 9704 8141, Fax. +61 2 9704 8139

Austria: Computerstr. 6, A-1101 WIEN, P.O. Box 213,
Tel. +43 1 60 101 1248, Fax. +43 1 60 101 1210

Belarus: Hotel Minsk Business Center, Bld. 3, r. 1211, Volodarski Str. 6,
220050 MINSK, Tel. +375 172 20 0733, Fax. +375 172 20 0773

Belgium: see The Netherlands

Brazil: see South America

Bulgaria: Philips Bulgaria Ltd., Energoproject, 15th floor,
51 James Bourchier Blvd., 1407 SOFIA,
Tel. +359 2 68 9211, Fax. +359 2 68 9102

Canada: PHILIPS SEMICONDUCTORS/COMPONENTS,
Tel. +1 800 234 7381, Fax. +1 800 943 0087

China/Hong Kong: 501 Hong Kong Industrial Technology Centre,
72 Tat Chee Avenue, Kowloon Tong, HONG KONG,
Tel. +852 2319 7888, Fax. +852 2319 7700

Colombia: see South America

Czech Republic: see Austria

Denmark: Sydhavnsgade 23, 1780 COPENHAGEN V,
Tel. +45 33 29 3333, Fax. +45 33 29 3905

Finland: Sinikalliontie 3, FIN-02630 ESPOO,
Tel. +358 9 615 800, Fax. +358 9 6158 0920

France: 51 Rue Carnot, BP317, 92156 SURESNES Cedex,
Tel. +33 1 4099 6161, Fax. +33 1 4099 6427

Germany: Hammerbrookstraße 69, D-20097 HAMBURG,
Tel. +49 40 2353 60, Fax. +49 40 2353 6300

Hungary: see Austria

India: Philips INDIA Ltd, Band Box Building, 2nd floor,
254-D, Dr. Annie Besant Road, Worli, MUMBAI 400 025,
Tel. +91 22 493 8541, Fax. +91 22 493 0966

Indonesia: PT Philips Development Corporation, Semiconductors Division,
Gedung Philips, Jl. Buncit Raya Kav.99-100, JAKARTA 12510,
Tel. +62 21 794 0040 ext. 2501, Fax. +62 21 794 0080

Ireland: Newstead, Clonskeagh, DUBLIN 14,
Tel. +353 1 7640 000, Fax. +353 1 7640 200

Israel: RAPAC Electronics, 7 Kehilat Saloniki St, PO Box 18053,
TEL AVIV 61180, Tel. +972 3 645 0444, Fax. +972 3 649 1007

Italy: PHILIPS SEMICONDUCTORS, Via Casati, 23 - 20052 MONZA (MI),
Tel. +39 039 203 6838, Fax +39 039 203 6800

Japan: Philips Bldg 13-37, Kohnan 2-chome, Minato-ku,
TOKYO 108-8507, Tel. +81 3 3740 5130, Fax. +81 3 3740 5057

Korea: Philips House, 260-199 Itaewon-dong, Yongsan-ku, SEOUL,
Tel. +82 2 709 1412, Fax. +82 2 709 1415

Malaysia: No. 76 Jalan Universiti, 46200 PETALING JAYA, SELANGOR,
Tel. +60 3 750 5214, Fax. +60 3 757 4880

Mexico: 5900 Gateway East, Suite 200, EL PASO, TEXAS 79905,
Tel. +9-5 800 234 7381, Fax +9-5 800 943 0087

Middle East: see Italy

Netherlands: Postbus 90050, 5600 PB EINDHOVEN, Bldg. VB,
Tel. +31 40 27 82785, Fax. +31 40 27 88399

New Zealand: 2 Wagener Place, C.P.O. Box 1041, AUCKLAND,
Tel. +64 9 849 4160, Fax. +64 9 849 7811

Norway: Box 1, Manglerud 0612, OSLO,
Tel. +47 22 74 8000, Fax. +47 22 74 8341

Pakistan: see Singapore

Philippines: Philips Semiconductors Philippines Inc.,
106 Valero St. Salcedo Village, P.O. Box 2108 MCC, MAKATI,
Metro MANILA, Tel. +63 2 816 6380, Fax. +63 2 817 3474

Poland: Al.Jerozolimskie 195 B, 02-222 WARSAW,
Tel. +48 22 5710 000, Fax. +48 22 5710 001

Portugal: see Spain

Romania: see Italy

Russia: Philips Russia, Ul. Usatcheva 35A, 119048 MOSCOW,
Tel. +7 095 755 6918, Fax. +7 095 755 6919

Singapore: Lorong 1, Toa Payoh, SINGAPORE 319762,
Tel. +65 350 2538, Fax. +65 251 6500

Slovakia: see Austria

Slovenia: see Italy

South Africa: S.A. PHILIPS Pty Ltd., 195-215 Main Road Martindale,
2092 JOHANNESBURG, P.O. Box 58088 Newville 2114,
Tel. +27 11 471 5401, Fax. +27 11 471 5398

South America: Al. Vicente Pinzon, 173, 6th floor,
04547-130 SÃO PAULO, SP, Brazil,
Tel. +55 11 821 2333, Fax. +55 11 821 2382

Spain: Balmes 22, 08007 BARCELONA,
Tel. +34 93 301 6312, Fax. +34 93 301 4107

Sweden: Kottbygatan 7, Akalla, S-16485 STOCKHOLM,
Tel. +46 8 5985 2000, Fax. +46 8 5985 2745

Switzerland: Allmendstrasse 140, CH-8027 ZÜRICH,
Tel. +41 1 488 2741 Fax. +41 1 488 3263

Taiwan: Philips Semiconductors, 6F, No. 96, Chien Kuo N. Rd., Sec. 1,
TAIPEI, Taiwan Tel. +886 2 2134 2886, Fax. +886 2 2134 2874

Thailand: PHILIPS ELECTRONICS (THAILAND) Ltd.,
209/2 Sanpavuth-Bangna Road Prakanong, BANGKOK 10260,
Tel. +66 2 745 4090, Fax. +66 2 398 0793

Turkey: Yukari Dudullu, Org. San. Blg., 2.Cad. Nr. 28 81260 Umraniye,
ISTANBUL, Tel. +90 216 522 1500, Fax. +90 216 522 1813

Ukraine: PHILIPS UKRAINE, 4 Patrice Lumumba str., Building B, Floor 7,
252042 KIEV, Tel. +380 44 264 2776, Fax. +380 44 268 0461

United Kingdom: Philips Semiconductors Ltd., 276 Bath Road, Hayes,
MIDDLESEX UB3 5BX, Tel. +44 208 730 5000, Fax. +44 208 754 8421

United States: 811 East Arques Avenue, SUNNYVALE, CA 94088-3409,
Tel. +1 800 234 7381, Fax. +1 800 943 0087

Uruguay: see South America

Vietnam: see Singapore

Yugoslavia: PHILIPS, Trg N. Pasica 5/v, 11000 BEOGRAD,
Tel. +381 11 3341 299, Fax.+381 11 3342 553

For all other countries apply to: Philips Semiconductors,
International Marketing & Sales Communications, Building BE-p, P.O. Box 218,
5600 MD EINDHOVEN, The Netherlands, Fax. +31 40 27 24825

Internet: <http://www.semiconductors.philips.com>

© Philips Electronics N.V. 2000

SCA 69

All rights are reserved. Reproduction in whole or in part is prohibited without the prior written consent of the copyright owner.

The information presented in this document does not form part of any quotation or contract, is believed to be accurate and reliable and may be changed without notice. No liability will be accepted by the publisher for any consequence of its use. Publication thereof does not convey nor imply any license under patent- or other industrial or intellectual property rights.

Printed in The Netherlands

465006/03/pp44

Date of release: 2000 Feb 11

Document order number: 9397 750 06616

Let's make things better.

Philips
Semiconductors



PHILIPS