

International Rectifier

IRF740LC

HEXFET® Power MOSFET

- Ultra Low Gate Charge
- Reduced Gate Drive Requirement;
- Enhanced 30V V_{GS} Rating
- Reduced C_{iss}, C_{oss}, C_{rss}
- Extremely High Frequency Operation
- Repetitive Avalanche Rated

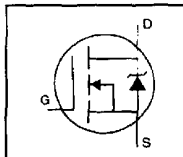

$$V_{DS} = 400V$$

$$R_{DS(on)} = 0.55\Omega$$

$$I_D = 10A$$

Description

This new series of Low Charge HEXFETs achieve significantly lower gate charge over conventional MOSFETs. Utilizing the new LCDMOS technology, the device improvements are achieved without added product cost, allowing for reduced gate drive requirements and total system savings. In addition, reduced switching losses and improved efficiency are achievable in a variety of high frequency applications. Frequencies of a few MHz at high current are possible using the new Low Charge MOSFETs.

These device improvements combined with the proven ruggedness and reliability that are characteristic of HEXFETs offer the designer a new standard in power transistors for switching applications.

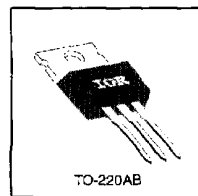

Absolute Maximum Ratings

Parameter	Max.	Units
I_D @ $T_C = 25^\circ\text{C}$	Continuous Drain Current, $V_{GS} = 10\text{ V}$	10
I_D @ $T_C = 100^\circ\text{C}$	Continuous Drain Current, $V_{GS} = 10\text{ V}$	6.3
I_{DM}	Pulsed Drain Current $\text{\textcircled{1}}$	32
P_D @ $T_C = 25^\circ\text{C}$	Power Dissipation	125
	Linear Derating Factor	1.0
V_{GS}	Gate-to-Source Voltage	± 33
E_{AS}	Single Pulse Avalanche Energy $\text{\textcircled{2}}$	520
I_{AR}	Avalanche Current $\text{\textcircled{3}}$	10
E_{AR}	Repetitive Avalanche Energy $\text{\textcircled{3}}$	13
dv/dt	Peak Diode Recovery dv/dt $\text{\textcircled{3}}$	4.0
T_J	Operating Junction and Storage Temperature Range	-55 to +150
T_{STG}	Soldering Temperature, for 10 seconds	300 (1.6mm from case)
	Mounting Torque, 6-32 or M3 screw	10 lbf.in (1.1 N.m)

Thermal Resistance

Parameter	Parameter	Min.	Typ.	Max.	Units
$R_{\theta JC}$	Junction-to-Case	—	—	1.0	—
$R_{\theta CS}$	Case-to-Sink, Flat, Greased Surface	—	0.50	—	$^\circ\text{C/W}$
$R_{\theta JA}$	Junction-to-Ambient	—	—	62	—

IRF740LC



Electrical Characteristics @ T_J = 25°C (unless otherwise specified)

Parameter	Min.	Typ.	Max.	Units	Test Conditions
V _{DR(BR)SS}	400	—	—	V	V _{GS} =0V, I _D =250μA
ΔV _{DR(BR)SS} /ΔT _J	—	0.76	—	V/°C	Reference to 25°C, I _D =1mA
R _{DS(on)}	—	—	0.55	Ω	V _{DS} =10V, I _D =6.0A ⓐ
V _{GS(th)}	2.0	—	4.0	V	V _{DS} =V _{GS} , I _D =250μA
g _{fs}	3.0	—	—	S	V _{DS} =50V, I _D =6.0A ⓐ
I _{DSS}	—	—	25	μA	V _{DS} =400V, V _{GS} =0V
I _{DSS}	—	—	250	μA	V _{DS} =320V, V _{GS} =0V, T _J =125°C
I _{DSS}	—	—	100	nA	V _{GS} =20V
I _{DSS}	—	—	-100	nA	V _{GS} =-20V
Q _g	—	—	39	nC	I _D =10A
Q _{gs}	—	—	10	nC	V _{DS} =320V
Q _{gd}	—	—	19	nC	V _{GS} =10V See Fig. 6 and 13 ⓐ
t _{d(on)}	—	11	—	ns	V _{DS} =200V
t _r	—	31	—	ns	I _D =10A
t _{d(off)}	—	25	—	ns	R _G =9.1Ω
t _f	—	20	—	ns	R _D =20Ω See Figure 10 ⓐ
L _D	—	4.5	—	nH	Between lead, 6 mm (0.25in.) from package and center of die contact
L _S	—	7.5	—	nH	
C _{iss}	—	1100	—	pF	V _{GS} =0V
C _{oss}	—	190	—	pF	V _{DS} =25V
C _{rss}	—	18	—	pF	f=1 MHz See Figure 5

Source-Drain Ratings and Characteristics

Parameter	Min.	Typ.	Max.	Units	Test Conditions
I _S	—	—	10	A	MOSFET symbol showing the integral reverse p-n junction diode.
I _{SM}	—	—	32	A	
V _{SD}	—	—	2.0	V	T _J =25°C, I _S =10A, V _{GS} =0V ⓐ
t _{rr}	—	380	570	ns	T _J =25°C, I _F =10A
Q _{rr}	—	2.8	4.2	μC	di/dt=100A/μs ⓐ
t _{on}	Intrinsic turn-on time is negligible (turn-on is dominated by L _S +L _D)				

Notes:

- ⓐ Repetitive rating; pulse width limited by max. junction temperature (See Figure 11)
- ⓑ I_{SDS}≤10A, di/dt≤120A/μs, V_{DS}≤V_{DR(BR)SS}, T_J≤150°C
- ⓒ V_{DS}=50V, starting T_J=25°C, L=9.1mH, R_G=25Ω, I_{AS}=10A (See Figure 12)
- ⓓ Pulse width ≤ 300 μs; duty cycle ≤2%.

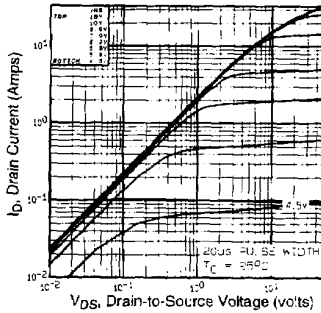

Fig 1. Typical Output Characteristics,
 $T_C=25^\circ\text{C}$

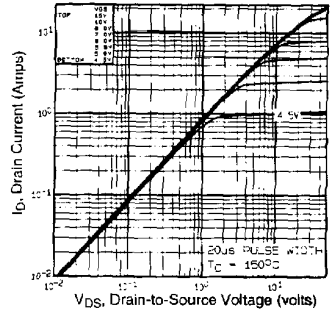

Fig 2. Typical Output Characteristics,
 $T_C=150^\circ\text{C}$

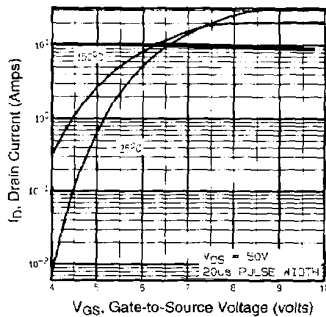

Fig 3. Typical Transfer Characteristics

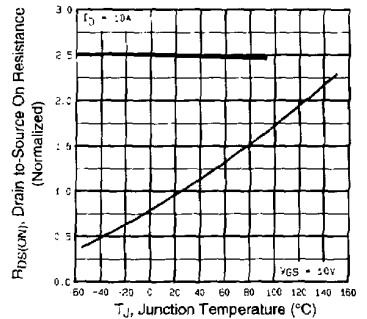

Fig 4. Normalized On-Resistance
Vs. Temperature

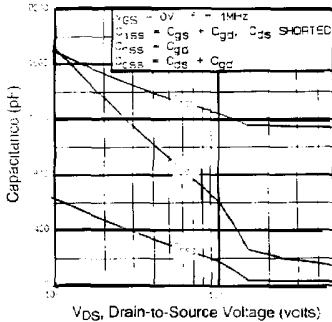

Fig 5. Typical Capacitance Vs. Drain-to-Source Voltage

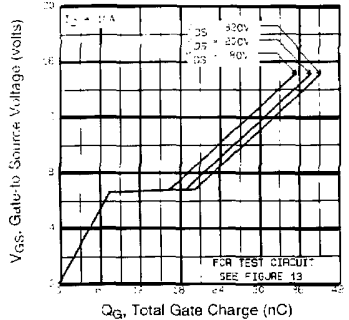

Fig 6. Typical Gate Charge Vs. Gate-to-Source Voltage

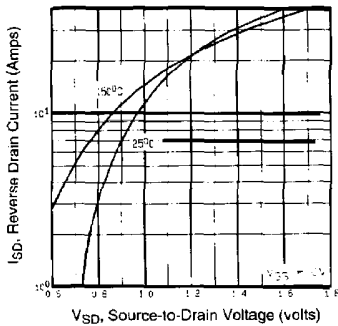

Fig 7. Typical Source-Drain Diode Forward Voltage

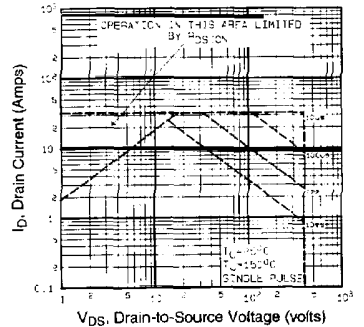

Fig 8. Maximum Safe Operating Area

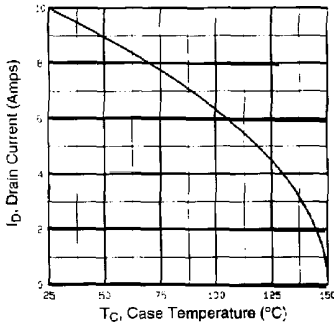

Fig 9. Maximum Drain Current Vs. Case Temperature

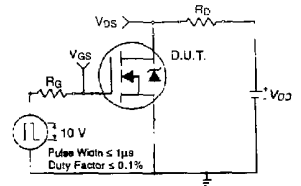

Fig 10a. Switching Time Test Circuit

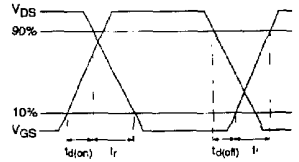

Fig 10b. Switching Time Waveforms

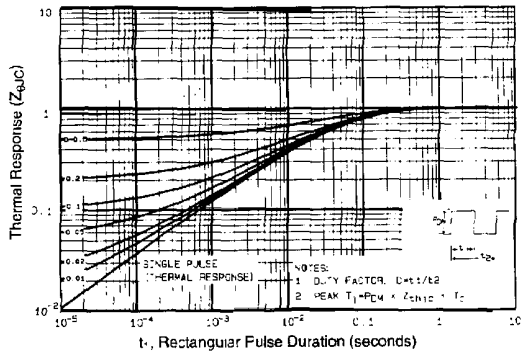

Fig 11. Maximum Effective Transient Thermal Impedance, Junction-to-Case

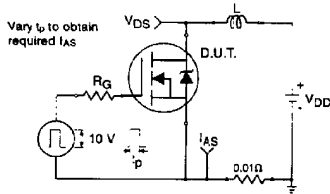

Fig 12a. Unclamped Inductive Test Circuit

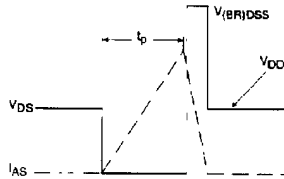

Fig 12b. Unclamped Inductive Waveforms

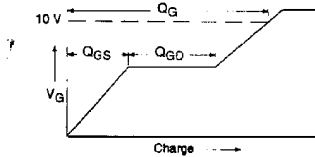

Fig 13a. Basic Gate Charge Waveform

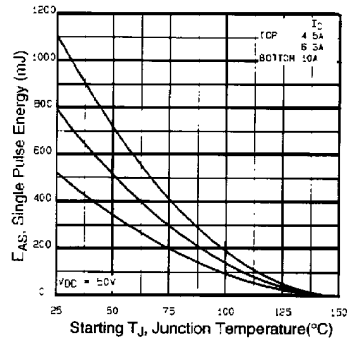

Fig 13c. Maximum Avalanche Energy Vs. Drain Current

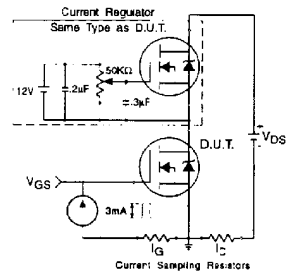

Fig 13b. Gate Charge Test Circuit

Appendix A: Figure 14, Peak Diode Recovery dv/dt Test Circuit

Appendix B: Package Outline Mechanical Drawing

Appendix C: Part Marking Information

Appendix A

Peak Diode Recovery dv/dt Test Circuit

Fig 14. For N-Channel HEXFETs

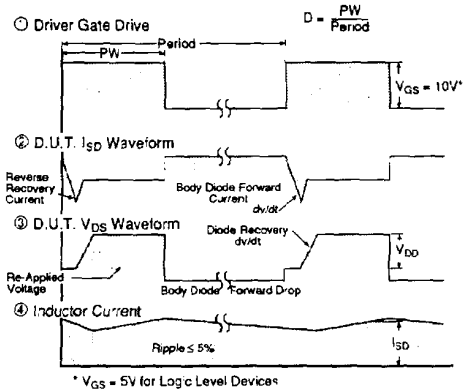
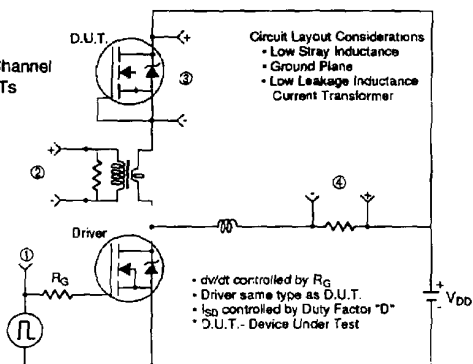

IRF740LC



Package Outline

Appendix B

TO-220AB Outline

Dimensions are shown in millimeters (inches)

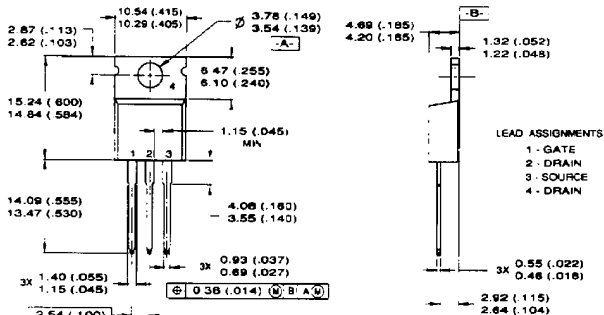

NOTES

2X

- 1 DIMENSIONING & TOLERANCING PER ANSI Y14.5M, 1982
- 2 CONTROLLING DIMENSION: INCH.
- 3 OUTLINE CONFORMS TO JEDEC OUTLINE TO-220-AB.
- 4 HEATSIK & LEAD MEASUREMENTS DO NOT INCLUDE BURRS.

Part Marking Information

Appendix C

TO-220AB

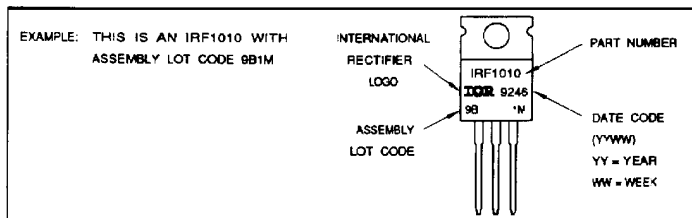

Printed or Signal recycled offset:
made from 50% recycled waste paper, including
10% de-inked, post-consumer waste.



International Rectifier

WORLD HEADQUARTERS: 233 Manassas St., El Segundo, California 90245 Tel: (310) 322-3331 Fax: 4720423
EUROPEAN HEADQUARTERS: Hurst Green, Oxon, Surrey RH8 9BB England. Tel: (0883) 713215. Fax: 9529

IR/CANADA: 101 Bentley St., Markham, Ontario L3R 3L1, Tel: (416) 475-1887 **IR GERMANY:** Seelburgstrasse 157, D-8380 Bad Homburg, Tel: 67-72-3706A **IR ITALY:** Via Liguria 49
12071 Borgate, Torino, Tel: (011) 470 1484. **IR JAPAN:** 1601 Building, 28-4 Nishinokukuro 3-Chome, Toshima-Ku, Tokyo 171 Japan. Tel: (03) 963 0041 **IR SOUTHEAST ASIA:**
180 Middle Road, MEX 10-01 Fortuna Centre, Singapore 0704. Tel: (65) 238 3822.

Sales Offices, Agents and Distributors in Major Cities Throughout the World.