

2N2484

Features

- Meets MIL 19500 /376
- Collector - Base Voltage 60 V
- Collector - Current 50 mA
- High Speed, Low Power Bipolar Transistor

**SWITCHING
 TRANSISTOR
 JAN, JANTX, JANTXV**

**SMALL SIGNAL
 BIPOLAR
 NPN SILICON**

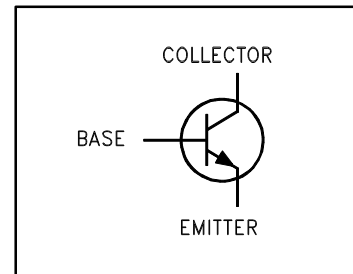
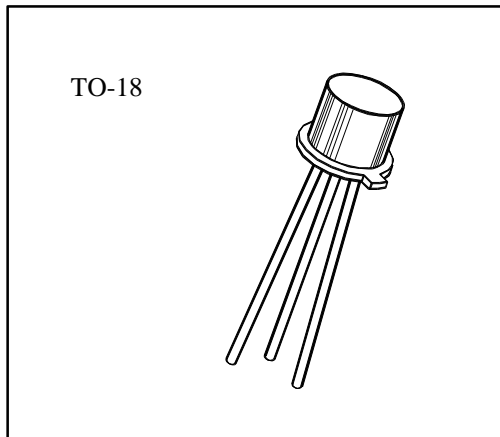

Maximum Ratings

RATING	SYMBOL	VALUE	UNIT
Collector - Emitter Voltage	V_{CEO}	60	Vdc
Collector - Base Voltage	V_{CB0}	60	Vdc
Emitter - Base Voltage	V_{EBO}	6	Vdc
Collector Current - Continuous	I_C	50	mAdc
Total Device Dissipation @ $T_A = 25\text{ }^\circ\text{C}$	P_D	360	mW
Derate above 25 $^\circ\text{C}$		2.06	mW/ $^\circ\text{C}$
Total Device Dissipation @ $T_C = 25\text{ }^\circ\text{C}$	P_D	1.2	WATTS
Derate above 25 $^\circ\text{C}$		6.85	mW/ $^\circ\text{C}$
Operating Junction&Storage Temperature Range	T_J, T_{stg}	-65 to +200	$^\circ\text{C}$

Thermal Characteristics

CHARACTERISTIC	SYMBOL	MAX	UNIT
Thermal Resistance, Junction to Ambient	$R_{\theta JA}$	485	$^\circ\text{C/W}$

Electrical Characteristics ($T_A = 25^\circ\text{C}$ unless otherwise noted)

OFF CHARACTERISTIC	SYMBOL	MIN	MAX	UNIT
Collector - Emitter Breakdown Voltage (1)	$V(BR)_{CEO}$			
($I_C = 10 \text{ mAdc}$, $I_B = 0$)		60		Vdc
Collector - Base Breakdown Voltage	$V(BR)_{CBO}$			
($I_C = 10 \text{ mAdc}$, $I_E = 0$)		60		Vdc
Emitter - Base Breakdown Voltage	$V(BR)_{EBO}$			
($I_E = 10 \text{ mAdc}$, $I_C = 0$)		6		Vdc
Collector - Base Cutoff Current	I_{CBO}			
($V_{CB} = 45 \text{ Vdc}$, $I_E = 0$)			5	nAdc
($V_{CB} = 45 \text{ Vdc}$, $I_E = 0$, $T_A = 150^\circ\text{C}$)			10	mAdc
Collector - Emitter Cutoff Current	I_{CEO}			
($V_{CE} = 5 \text{ Vdc}$, $I_B = 0$)			2	nAdc
Collector - Emitter Cutoff Current	I_{CES}			
($V_{CE} = 45 \text{ Vdc}$, $V_{BE} = 0$)			5	nAdc
Emitter - Base Cutoff Current	I_{EBO}			
($V_{EB} = 5 \text{ Vdc}$)			2	nAdc

ON CHARACTERISTIC	SYMBOL	MIN	MAX	UNIT
DC Current Gain	h_{FE}			
($I_C = 1 \text{ mAdc}$, $V_{CE} = 5 \text{ Vdc}$)		45		
($I_C = 10 \text{ mAdc}$, $V_{CE} = 5 \text{ Vdc}$)		200	500	
($I_C = 100 \text{ mAdc}$, $V_{CE} = 5 \text{ Vdc}$)		225	675	
($I_C = 500 \text{ mAdc}$, $V_{CE} = 5 \text{ Vdc}$)		250	800	
($I_C = 1 \text{ mAdc}$, $V_{CE} = 5 \text{ Vdc}$)		250	800	
($I_C = 10 \text{ mAdc}$, $V_{CE} = 5 \text{ Vdc}$)		225	800	
($I_C = 10 \text{ mAdc}$, $V_{CE} = 5 \text{ Vdc}$, $T_J = -55^\circ\text{C}$)		35		
Collector- Emitter Saturation Voltage	$V_{CE(sat)}$			
($I_C = 1 \text{ mAdc}$, $I_B = 100 \text{ mAdc}$)			0.3	Vdc
Base - Emitter Non-Saturated Voltage	$V_{BE(on)}$			
($I_C = 100 \text{ mAdc}$, $V_{CE} = 5 \text{ Vdc}$)		0.5	0.7	Vdc

1. Pulse Test: Pulse Width $\leq 300 \mu\text{s}$, Duty Cycle $\leq 2\%$

Electrical Characteristics ($T_A = 25^\circ\text{C}$ unless otherwise noted)

SMALL - SIGNAL CHARACTERISTICS	SYMBOL	MIN	MAX	UNIT
Output Capacitance ($V_{CB} = 5 \text{ Vdc}$, $I_E = 0$, 100kHz \times f \leq 1 MHz)	C_{obo}		5	pF
Input Capacitance ($V_{EB} = 0.5 \text{ Vdc}$, $I_C = 0$, 100kHz \times f \leq 1 MHz)	C_{ibo}		6	pF

Small - Signal AC Characteristics ($T_A = 25^\circ\text{C}$)

LOW FREQUENCY	SYMBOL	MIN	MAX	UNIT
Common - Emitter Forward Current Transfer Ratio ($I_C = 1 \text{ mA}$, $V_{CE} = 5 \text{ V}$, $f = 1 \text{ kHz}$)	h_{fe}	250	900	
Common - Emitter Short Circuit Input Impedance ($I_C = 1 \text{ mA}$, $V_{CE} = 5 \text{ V}$, $f = 1 \text{ kHz}$)	h_{ie}	3.5	24	k Ω
Common - Emitter Open Circuit Output Admittance ($I_C = 1 \text{ mA}$, $V_{CE} = 5 \text{ V}$, $f = 1 \text{ kHz}$)	h_{oe}		40	mhos
Common-Emitter Open Circuit Reverse Voltage Transfer Ratio ($I_C = 1 \text{ mA}$, $V_{CE} = 5 \text{ V}$, $f = 1 \text{ kHz}$)	h_{re}		8.0×10^{-4}	
HIGH FREQUENCY AND NOISE				
Magnitude of Common Emitter				
Short Circuit Forward Current Transfer Ratio ($I_C = 50 \text{ mA}$, $V_{CE} = 5 \text{ V}$, $f = 5 \text{ MHz}$)	$ \hat{h}_{fe} $	3.0		
($I_C = 500 \text{ mA}$, $V_{CE} = 5 \text{ V}$, $f = 30 \text{ MHz}$)		2.0	7.0	
Noise Figure ($I_C = 10 \text{ mA}$, $V_{CE} = 5 \text{ Vdc}$, $R_G = 10 \text{ k}\Omega$, $f = 100 \text{ Hz}$)	F_1		7.5	dB
Noise Figure ($I_C = 10 \text{ mA}$, $V_{CE} = 5 \text{ Vdc}$, $R_G = 10 \text{ k}\Omega$, $f = 1 \text{ kHz}$)	F_2		3.0	dB
Noise Figure ($I_C = 10 \text{ mA}$, $V_{CE} = 5 \text{ Vdc}$, $R_G = 10 \text{ k}\Omega$, $f = 10 \text{ kHz}$)	F_3		2.0	dB
Wide Band Noise Figure ($I_C = 10 \text{ mA}$, $V_{CE} = 5 \text{ Vdc}$, $R_G = 10 \text{ k}\Omega$, $f = 10 \text{ Hz to } 15.7 \text{ kHz}$)	F_4		3.0	dB

Spice Model (based upon typical device characteristics) *1

Q2N2484 NPN (IS = 66.4p XTI = 2.0m EG = 1.11 VAF = 73.1 BF = 660.0 ISE = 48.8n
 + NE = 46.13 IKF = 8.98m NK = 0.123 XTB = 1.5 BR = 1.0 ISC = 66.4p
 + NC = 2.51 IKR = 1.23 RC = 0.738 CJC = 4.74p VJC = 0.933 MJC = 0.35
 + FC = 0.5 CJE = 6.0p VJE = 0.6 MJE = 0.34 TR = 25.96n TF = 1.918n
 + ITF = 1.0 XTF = 0 VTF = 10.0)

*1. Microsemi Corp. claims no responsibility for misapplication of Spice Model information. Spice modeling should be used as a precursor guide to in-circuit performance. Actual performance is the responsibility of the user / designer.

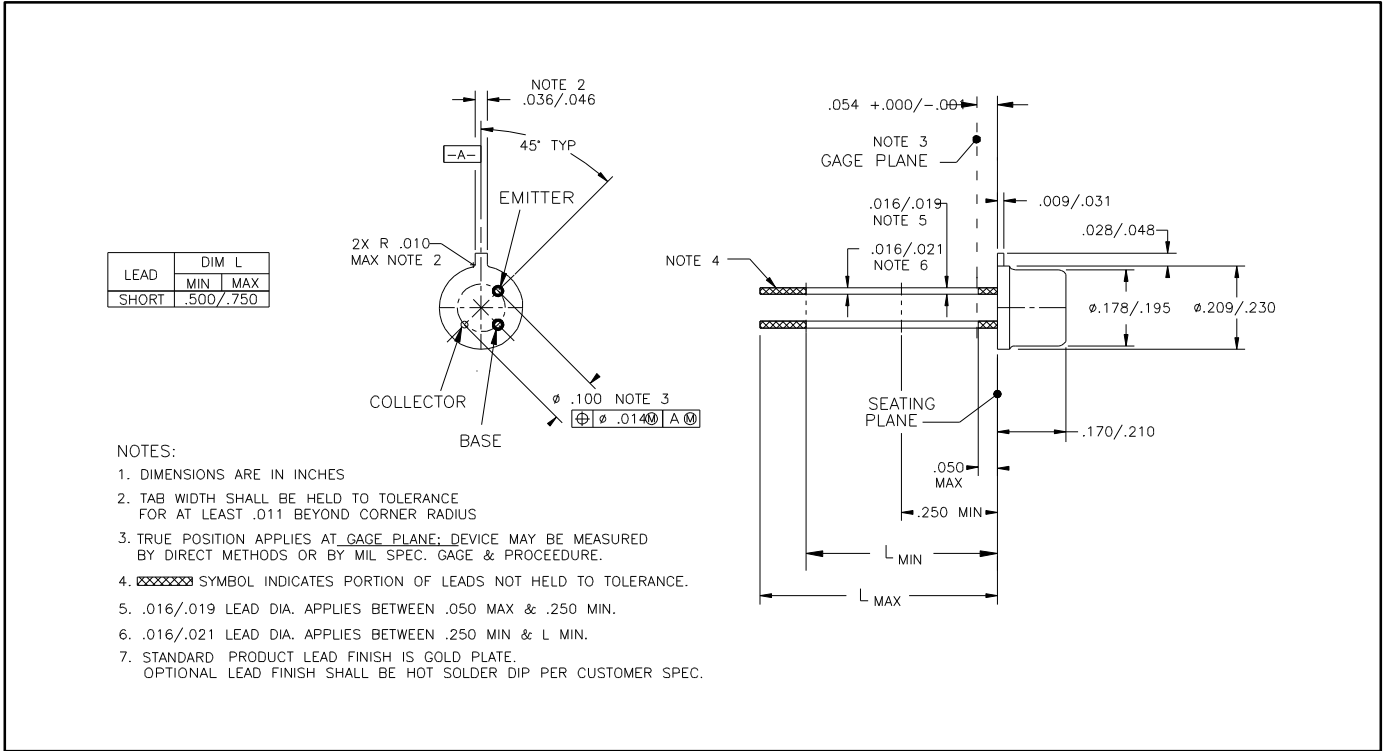

TO 18 CASE OUTLINE

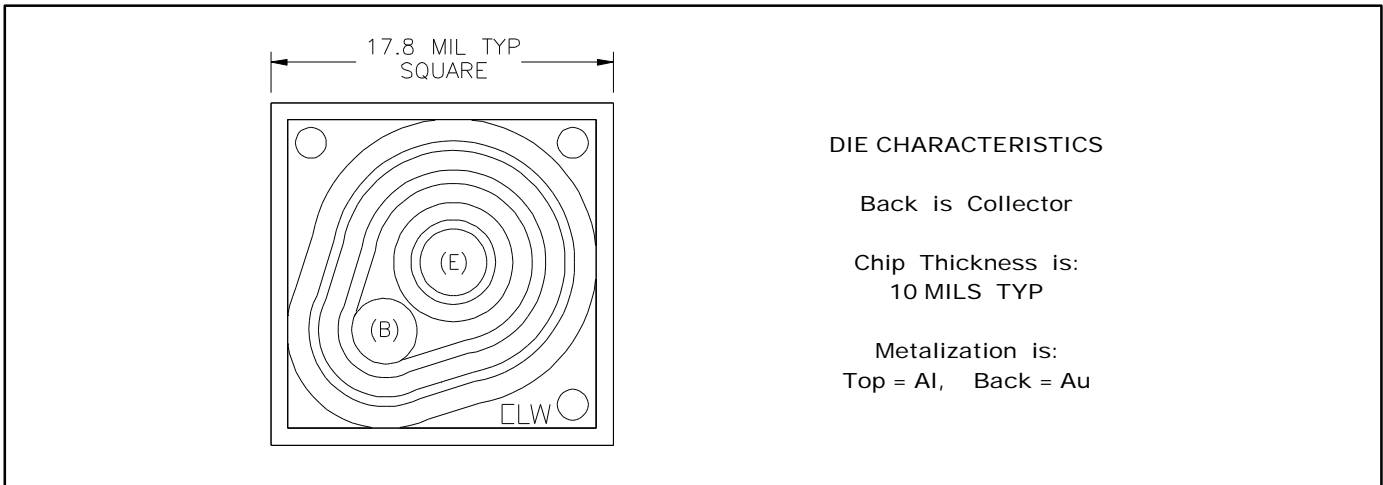

DIE OUTLINE

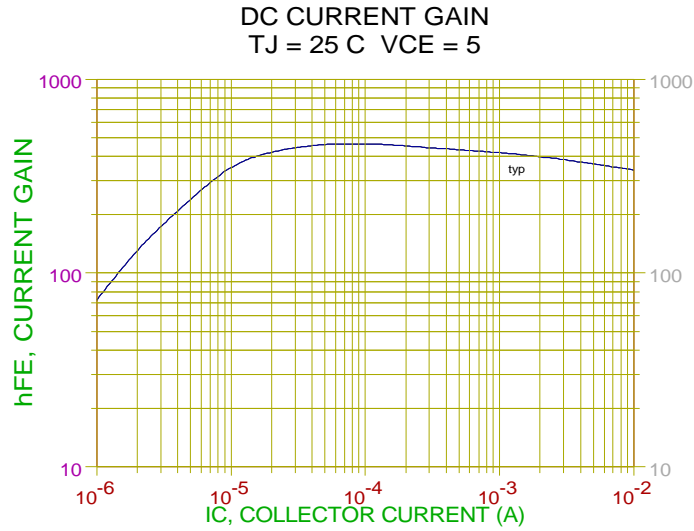

FIGURE 1

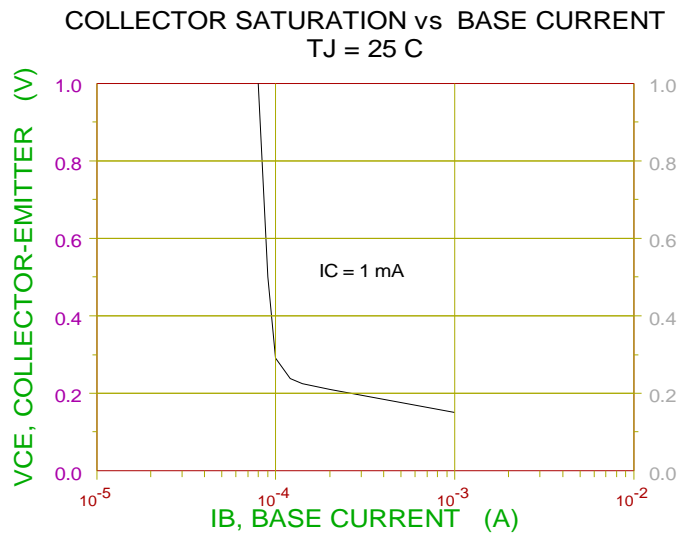

FIGURE 2

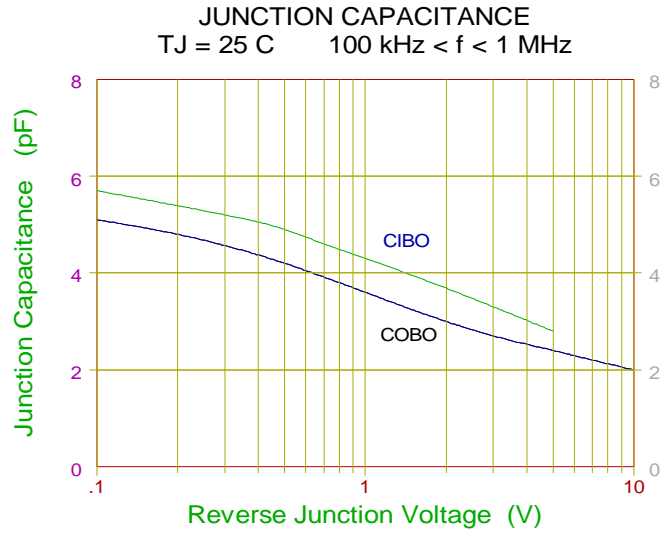

FIGURE 3

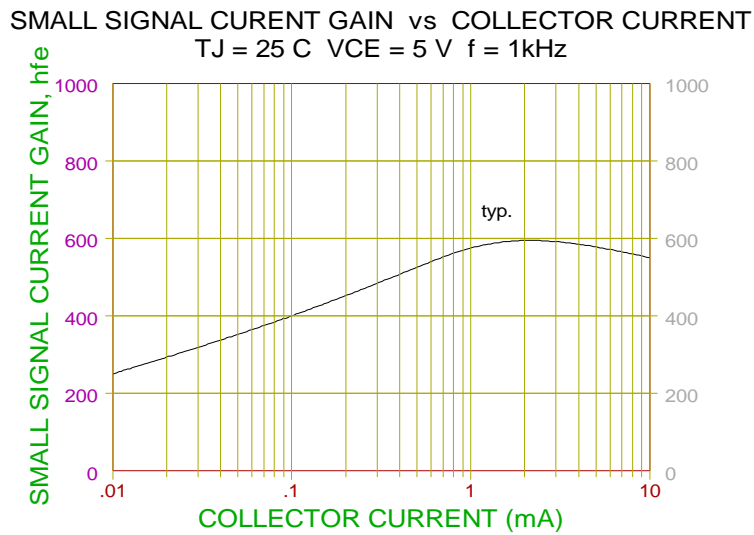

FIGURE 4

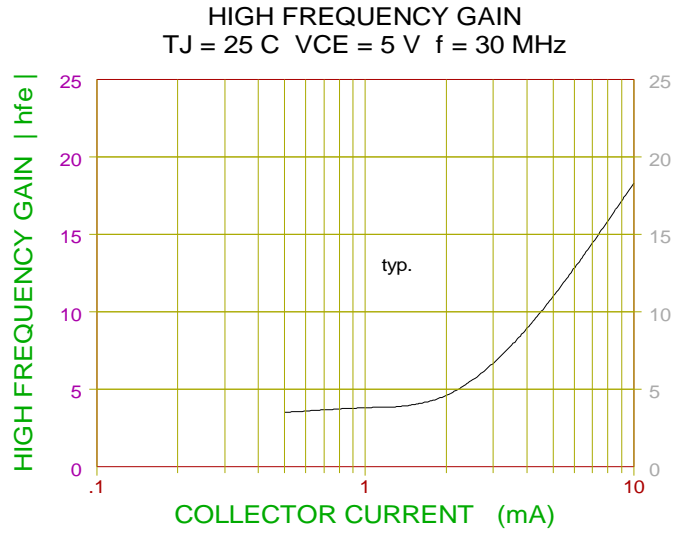

FIGURE 5

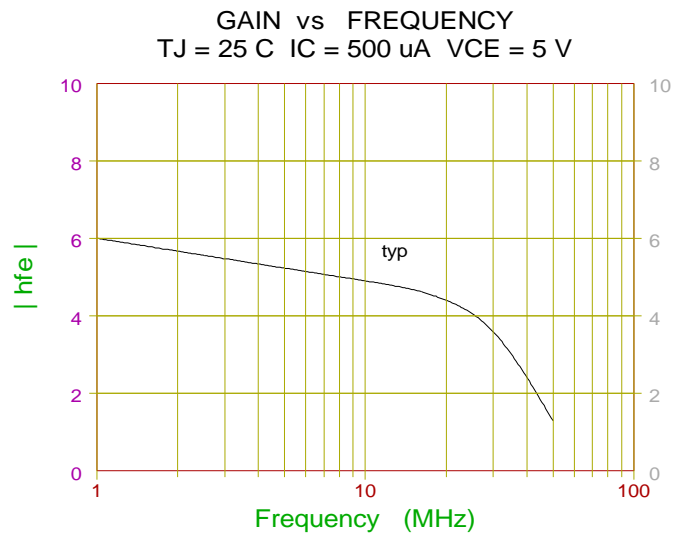

FIGURE 6

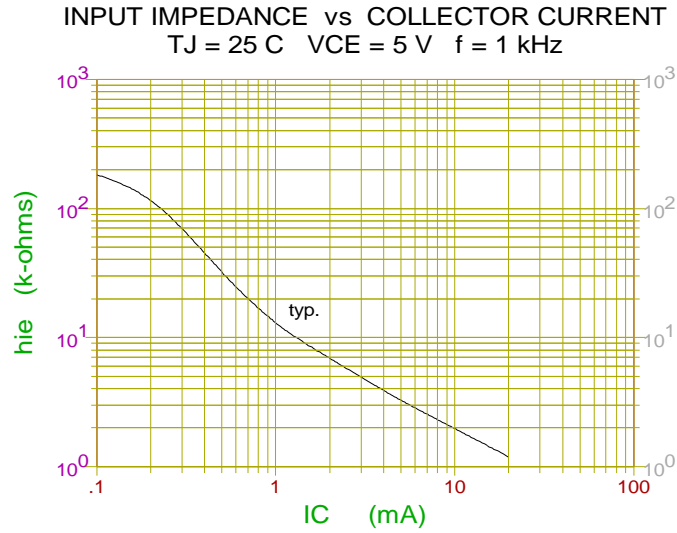

FIGURE 7

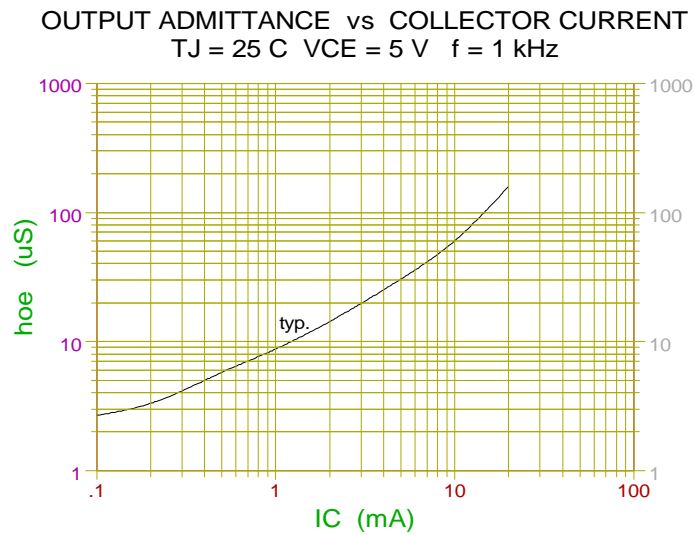

FIGURE 8

VOLTAGE FEEDBACK RATIO vs COLLECTOR CURRENT
 T_J = 25 C V_{CE} = 5 V f = 1kHz

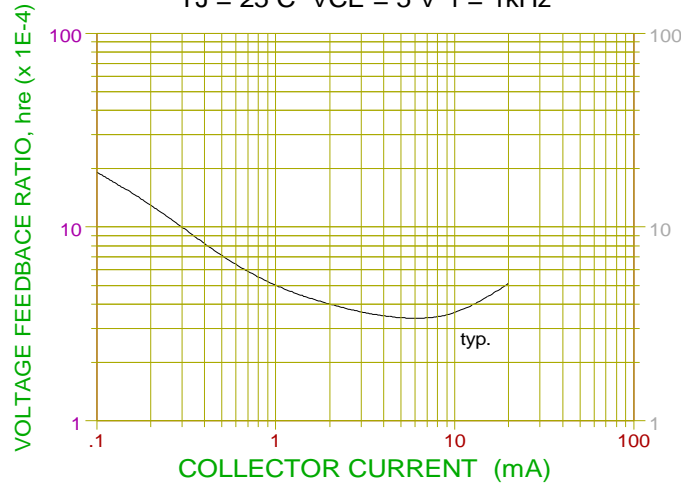

FIGURE 9

NOISE FIGURE (db) VS COLLECTOR CURRENT
 T_J = 25 C V_{CE} = 5 V R_G = 10 k f = 1 kHz

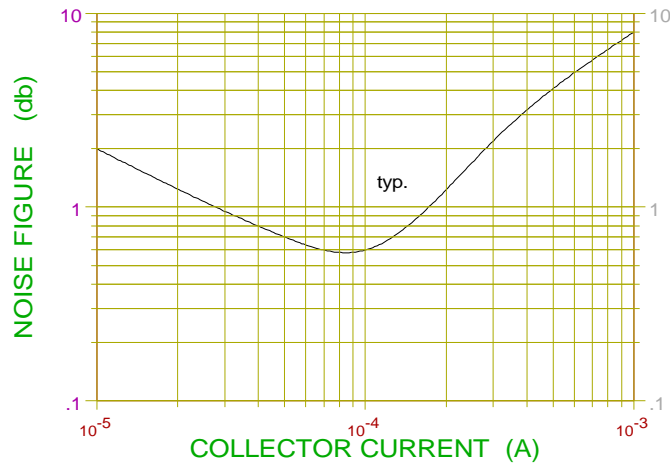

FIGURE 10

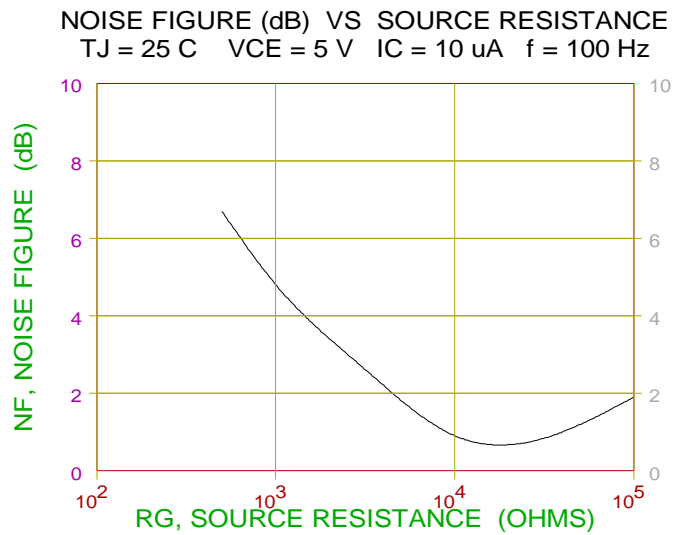

FIGURE 11