

TA2018FN

DC/DC CONVERTER FOR ELECTRIC TUNING (1.5V USE)

The TA2018FN is a DC/DC converter IC which is developed for biasing variable capacitance diodes of tuner system. It is especially suitable for supplying high voltage (about 14.3V) for digital tuning (FM/TV/AM) system at low power operation.

FEATURES

- Few external parts.
- Excellent spurious radiation by oscillation of sine wave.
- Output voltage : $V_O = 14.3V$ (Typ.)
- Excellent regulatory capability of output voltage against fluctuation of supply voltage, and of ambient temperature.
- Built-in constant current source, it is suitable for digital tuning system. (I_{CTL} can be controlled by R_{CTL})
- Built-in power switch.
- Low supply current ($V_{CC} = 1.2V$, $T_a = 25^\circ C$, $I_O = 30\mu A$)
 $I_{CC} = 2.1mA$ (Typ.)
- Operating supply voltage range ($T_a = 25^\circ C$)
 $V_{CC} (opr) = 0.9\sim 4V$

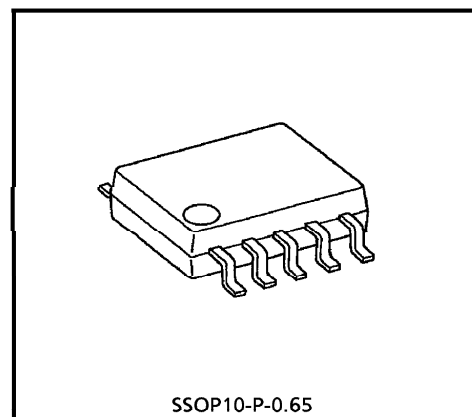

SSOP10-P-0.65
Weight : 0.04g (Typ.)

Marking

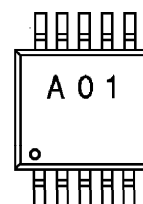

BLOCK DIAGRAM

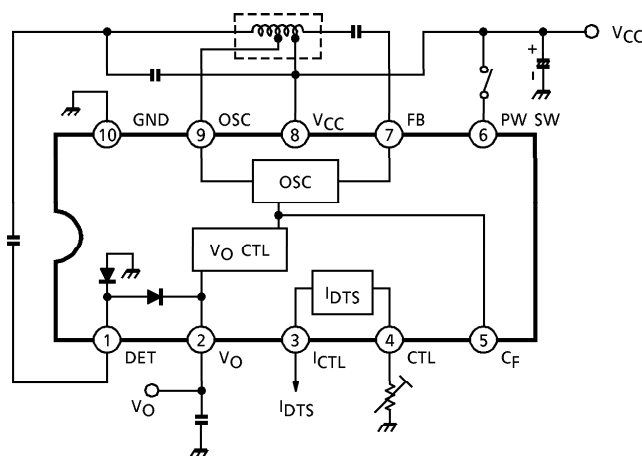

980910EBA2

● TOSHIBA is continually working to improve the quality and the reliability of its products. Nevertheless, semiconductor devices in general can malfunction or fail due to their inherent electrical sensitivity and vulnerability to physical stress. It is the responsibility of the buyer, when utilizing TOSHIBA products, to observe standards of safety, and to avoid situations in which a malfunction or failure of a TOSHIBA product could cause loss of human life, bodily injury or damage to property. In developing your designs, please ensure that TOSHIBA products are used within specified operating ranges as set forth in the most recent products specifications. Also, please keep in mind the precautions and conditions set forth in the TOSHIBA Semiconductor Reliability Handbook.

● The products described in this document are subject to the foreign exchange and foreign trade laws.

● The information contained herein is presented only as a guide for the applications of our products. No responsibility is assumed by TOSHIBA CORPORATION for any infringements of intellectual property or other rights of the third parties which may result from its use. No license is granted by implication or otherwise under any intellectual property or other rights of TOSHIBA CORPORATION or others.

● The information contained herein is subject to change without notice.

TERMINAL EXPLANATION

Terminal voltage : Typical terminal voltage with test circuit ($V_{CC} = 1.2V, T_a = 25^{\circ}C$)

TERMINAL		FUNCTION	INTERNAL CIRCUIT	TERMINAL VOLTAGE (V)
No.	NAME			
1	DET	<ul style="list-style-type: none"> • Boosted output (Voltage double rectifier) • Don't connect any external parts with this terminal 		—
2	V_O			14.3
5	C_F			0.4
3	I_{CTL}	<ul style="list-style-type: none"> • Constant current source V_O supplies this circuit with power source. (for digital tuning) 		—
4	CTL			—
6	PW SW	<ul style="list-style-type: none"> • Power on / off switch (V_{CC} : Power on Open / GND : Power off 		—
7	FB	<ul style="list-style-type: none"> • Hartley type oscillator $f_{osc} \doteq \frac{1}{2\pi\sqrt{L_3 \cdot C_1}}$ • Controlling oscillation current at the terminal of FB 		0.7
8	V_{CC}			1.2
9	OSC			—
10	GND	—	—	0

APPLICATION NOTE

1. PW SW

It is necessary to connect an external pull-down resistor with the terminal PW SW (pin 6), in case that this IC is turned on due to external noise etc.

2. Designing of coil

This IC has the output voltage by means of boosting the oscillation voltage, derived from Hartley type oscillator circuit and of voltage-double rectifier with C₃, D₁ and D₂.

(1) Designing of oscillation frequency

$$f_{osc} \doteq \frac{1}{2\pi\sqrt{L_3 \cdot C_2}}$$

(2) Coil turns can be designed as following :

$$V_{osc(p-p)} = 2(V_{CC(min)} - V_{CE1(sat)})$$

$$n = \frac{n_3}{n_2} \doteq \frac{V_O}{V_{osc(p-p)}}$$

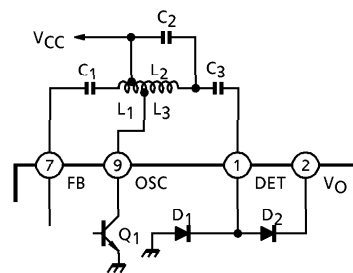

Fig.1 Oscillator and Voltage-Double

- (Note) V_{CC(min)} : minimum of supply voltage designed by a equipment
- V_{CE1(sat)} : saturation voltage of Q₁
- n : coil turns ratio (L₂, L₃)
- V_O : output voltage (V_O ≐ 14.3V)

The turn of L₁ is designed, so as to make the terminal of FB be about 200~300mVp-p through C₁. The turn of L₁ should be small, and the capacitance of C₁ and Q₀ of coil should be large, for the oscillation start at turning power on.

(3) Allowance is advisable for coil design of n, Q₀. However, spurious radiation can be reduced, in case that the output current and n of coil don't make large.

3. Pattern diagram

The Fig.2 shows the oscillation loop. This pattern diagram should be small, because spurious radiation due to the oscillation is reduced.

The Fig.3 shows the rectifier loop. This pattern diagram should be the small, because spurious radiation due to the switching rectifier is reduced. The two loops should be isolated from other DC lines.

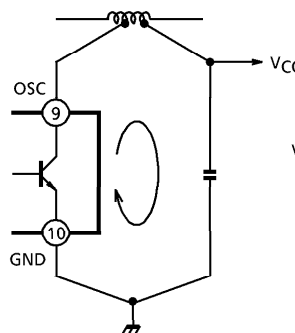

Fig.2 Oscillation Loop

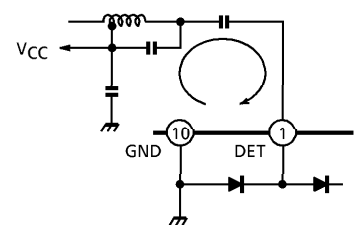

Fig.3 Rectifier Loop

4. Output current

Total output current (I_O and I_{CTL}) should not be smaller than $30\mu A$, because this IC start blocking oscillation etc. Note that this condition will change according to coil setting etc.

5. Terminal C_f

Any external parts should not be connected with this terminal, because this IC doesn't operate normally.

6. I_{CTL}

I_{CTL} can be controlled by R_{CTL} resistor between pin 4 and GND, note that I_{CTL} should be set to $180\mu A$ or smaller (see Fig.4).

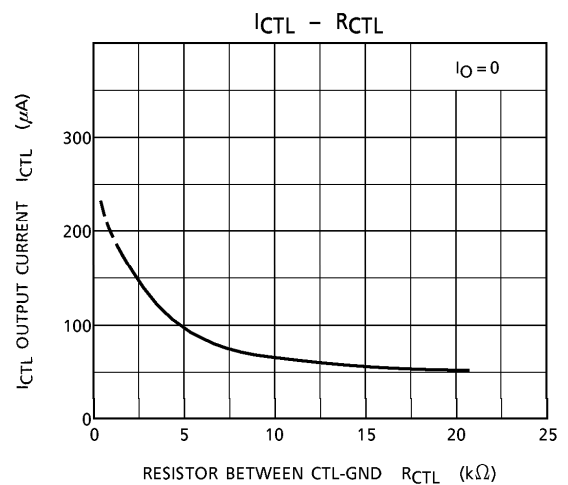

Fig.4 I_{CTL} - R_{CTL}

MAXIMUM RATINGS ($T_a = 25^\circ C$)

CHARACTERISTIC	SYMBOL	RATING	UNIT
Supply Voltage	V_{CC}	4.5	V
Output voltage	V_O	18	
Constant Current Source Circuit Output Current	I_{CTL}	5	mA
Power Dissipation (Note)	P_D	300	mW
Operating Temperature	T_{opr}	- 25~75	°C
Storage Temperature	T_{stg}	- 55~150	

(Note) Derated above $T_a = 25^\circ C$ in the proportion of 2.4mW.

ELECTRICAL CHARACTERISTICS

Unless otherwise specified : $V_{CC} = 1.2V$, $T_a = 25^{\circ}C$, $f_{osc} = 3MHz$, $I_O = 30\mu A$, $SW_1 : a$, $SW_2 : a$

CHARACTERISTIC	SYMBOL	TEST CIRCUIT	TEST CONDITION	MIN.	TYP.	MAX.	UNIT
Supply Current	I_{CC1}	—	PW OFF, $SW_1 : b$	—	—	5	μA
	I_{CC2}	—		—	2.1	3	mA
Boosted Output Voltage	V_O	—		13.5	14.3	15.1	V
V_O Supply Voltage Fluctuation	ΔV_O	—	$V_{CC} = 4V \rightarrow 0.9V$	-20	0	+20	mV
V_O Maximum Output Current	$I_O (MAX)$	—	$\Delta V_O = 50mV$, with respect to standard, $I_{CTL} = 30\mu A$	180	300	—	μA
V_O Ambient Temperature Coefficient	V_O / T	—		—	+1.2	—	mV / $^{\circ}C$
Constant Current Source Output Current	I_{CTL}	—	$I_O = 0$, $SW_2 : b$ ($R_{CTL} = 4.7k\Omega$)	80	100	120	μA
I_{CTL} Maximum Current	$I_{CTL} (MAX)$	—	$I_O = 0$, $SW_2 : b$, (adjust R_{CTL}) $\Delta V_O = 50mV$, with respect to standard, $I_{CTL} = 30\mu A$	—	270	—	μA
Power Switch On Current	I_6	—	$V_{CC} = 0.9V$, $V_O \geq 13V$, $SW_1 : c$	5	—	—	μA
Power Switch Off Voltage	V_6	—	$V_{CC} = 0.9V$, $V_O \leq 3.5V$, $SW_1 : d$	0	—	0.3	V

TEST CIRCUIT

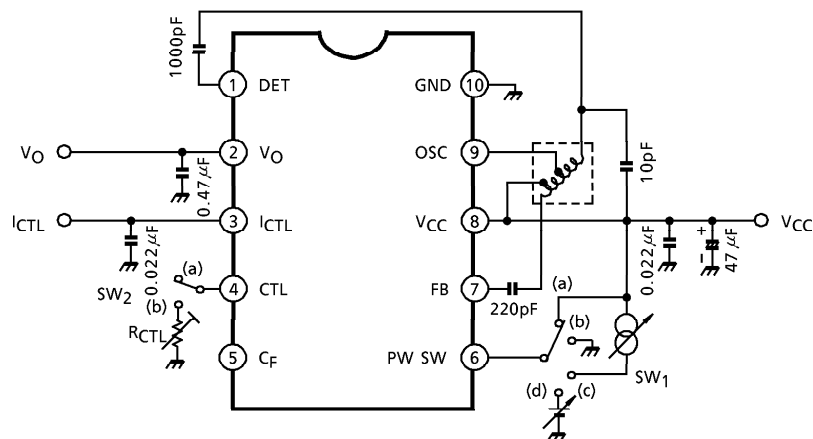

COIL DATA (TEST CIRCUIT)

TEST FREQUENCY	L (μH)	Q	TURN			WIRE (mm ϕ)	REFERENCE
	4-6		6-1	1-3	3-4		
796kHz	152	25	$2 \frac{1}{2}$	8	$89 \frac{1}{2}$	0.04UEW	SUMIDA ELECTRIC & Co.,Ltd. 5201-018

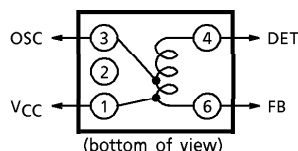

CHARACTERISTIC CURVES

Unless otherwise specified : $V_{CC} = 1.2V$, $I_O = 30\mu A$, $T_a = 25^\circ C$, $f_{osc} = 3MHz$

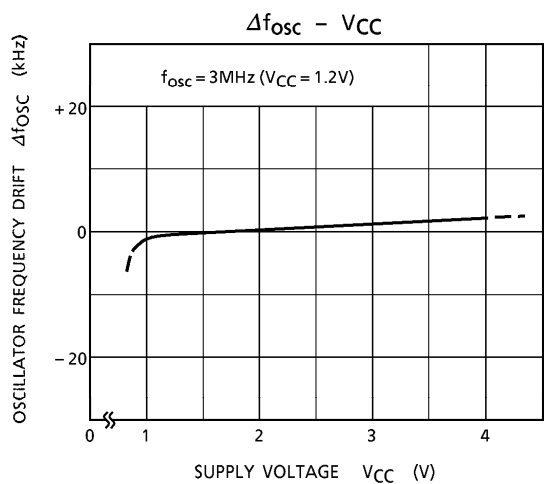
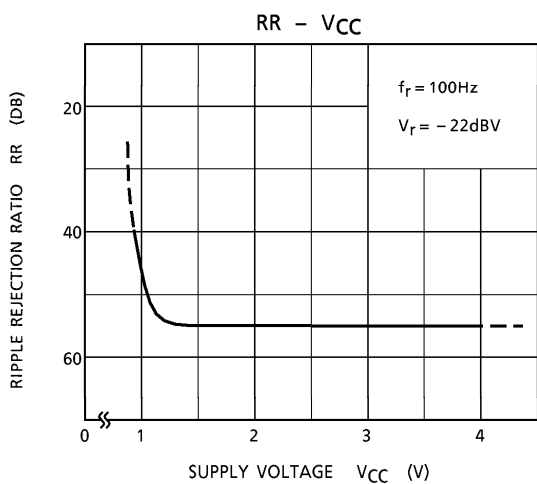
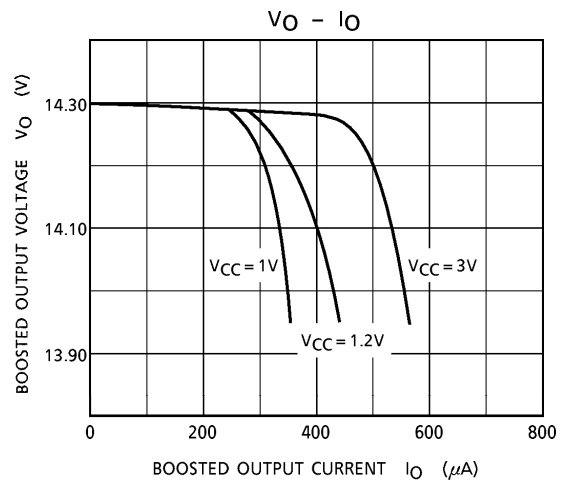
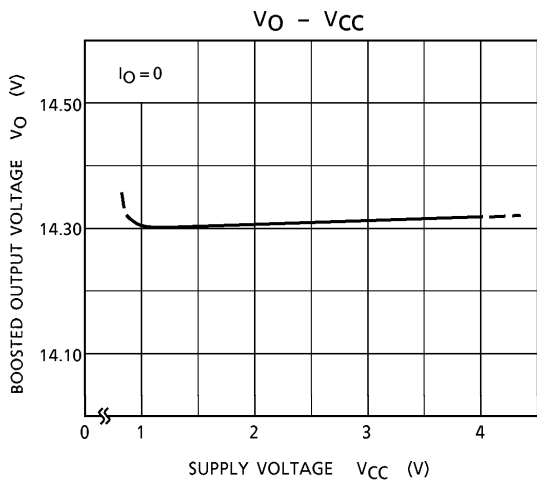
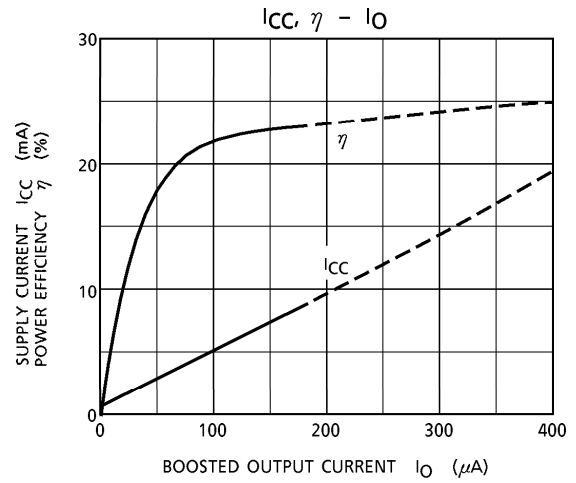
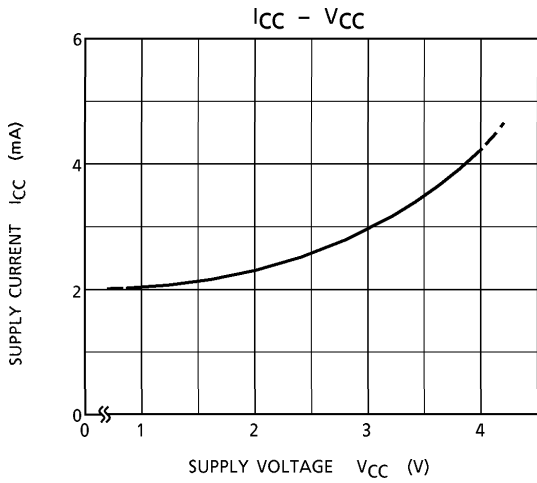

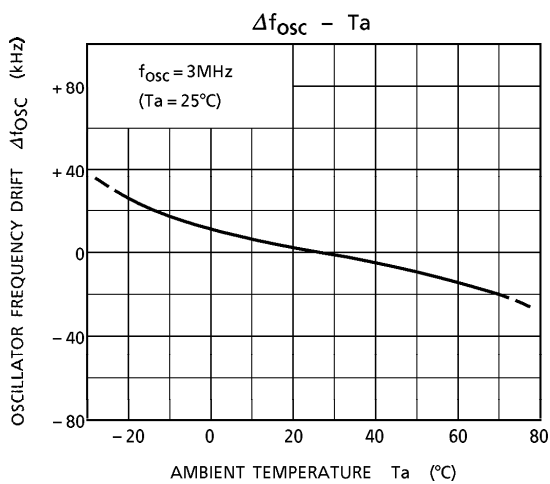
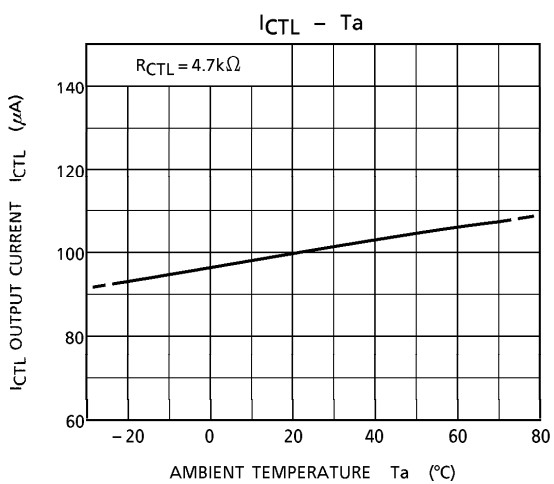
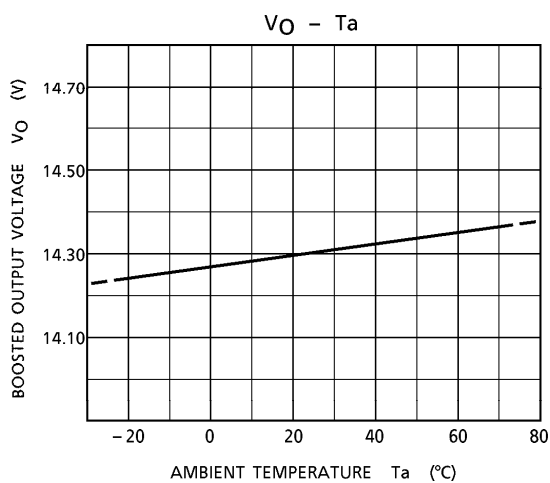
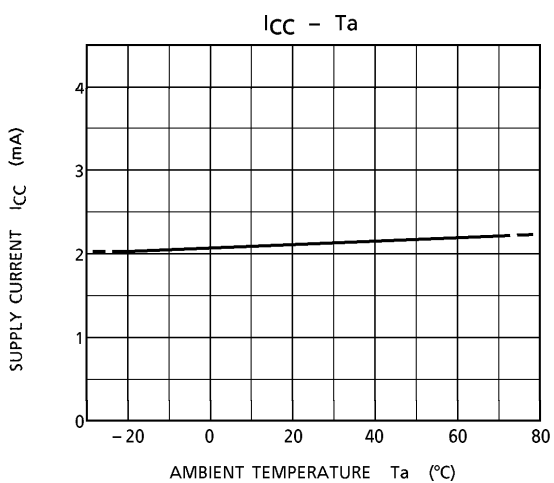

OUTLINE DRAWING
SSOP10-P-0.65

Unit : mm

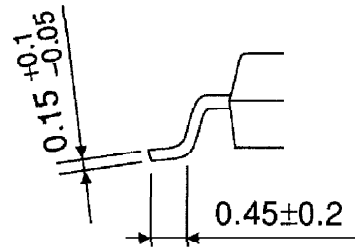
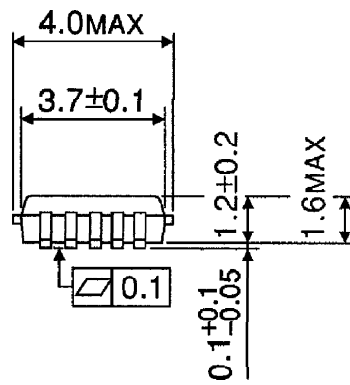
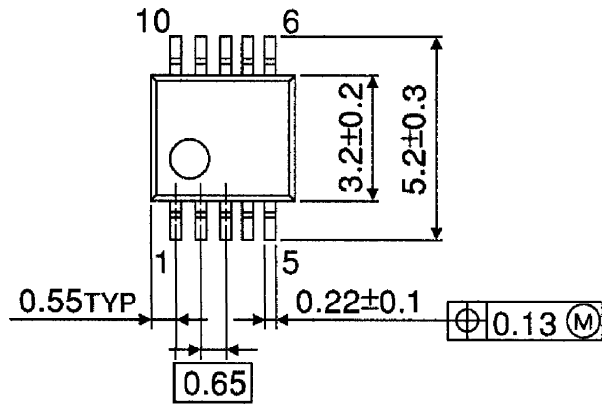

Weight : 0.04g (Typ.)