

MJE13009*

*Motorola Preferred Device

**12 AMPERE
NPN SILICON
POWER TRANSISTOR
400 VOLTS
100 WATTS**

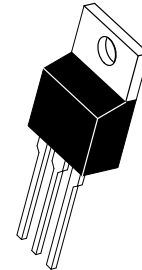

**CASE 221A-06
TO-220AB**

Designer's™ Data Sheet

SWITCHMODE Series

NPN Silicon Power Transistors

The MJE13009 is designed for high-voltage, high-speed power switching inductive circuits where fall time is critical. They are particularly suited for 115 and 220 V switchmode applications such as Switching Regulators, Inverters, Motor Controls, Solenoid/Relay drivers and Deflection circuits.

SPECIFICATION FEATURES:

- $V_{CEO(sus)}$ 400 V and 300 V
- Reverse Bias SOA with Inductive Loads @ $T_C = 100^\circ\text{C}$
- Inductive Switching Matrix 3 to 12 Amp, 25 and 100°C
... $t_C @ 8 \text{ A}, 100^\circ\text{C}$ is 120 ns (Typ).
- 700 V Blocking Capability
- SOA and Switching Applications Information.

MAXIMUM RATINGS

Rating	Symbol	Value	Unit
Collector-Emitter Voltage	$V_{CEO(sus)}$	400	Vdc
Collector-Emitter Voltage	V_{CEV}	700	Vdc
Emitter Base Voltage	V_{EBO}	9	Vdc
Collector Current — Continuous	I_C	12	Adc
— Peak (1)	I_{CM}	24	
Base Current — Continuous	I_B	6	Adc
— Peak (1)	I_{BM}	12	
Emitter Current — Continuous	I_E	18	Adc
— Peak (1)	I_{EM}	36	
Total Power Dissipation @ $T_A = 25^\circ\text{C}$	P_D	2	Watts
Derate above 25°C		16	mW/ $^\circ\text{C}$
Total Power Dissipation @ $T_C = 25^\circ\text{C}$	P_D	100	Watts
Derate above 25°C		800	mW/ $^\circ\text{C}$
Operating and Storage Junction Temperature Range	T_J, T_{stg}	-65 to +150	$^\circ\text{C}$

THERMAL CHARACTERISTICS

Characteristic	Symbol	Max	Unit
Thermal Resistance, Junction to Ambient	$R_{\theta JA}$	62.5	$^\circ\text{C/W}$
Thermal Resistance, Junction to Case	$R_{\theta JC}$	1.25	$^\circ\text{C/W}$
Maximum Lead Temperature for Soldering Purposes: 1/8" from Case for 5 Seconds	T_L	275	$^\circ\text{C}$

(1) Pulse Test: Pulse Width = 5 ms, Duty Cycle $\leq 10\%$.

Designer's Data for "Worst Case" Conditions — The Designer's Data Sheet permits the design of most circuits entirely from the information presented. SOA Limit curves — representing boundaries on device characteristics — are given to facilitate "worst case" design.

Preferred devices are Motorola recommended choices for future use and best overall value.

Designer's and SWITCHMODE are trademarks of Motorola, Inc.

REV 2

ELECTRICAL CHARACTERISTICS ($T_C = 25^\circ\text{C}$ unless otherwise noted)

Characteristic	Symbol	Min	Typ	Max	Unit
*OFF CHARACTERISTICS					
Collector–Emitter Sustaining Voltage ($I_C = 10\text{ mA}$, $I_B = 0$)	$V_{CEO(sus)}$	400	—	—	Vdc
Collector Cutoff Current ($V_{CEV} = \text{Rated Value}$, $V_{BE(off)} = 1.5\text{ Vdc}$) ($V_{CEV} = \text{Rated Value}$, $V_{BE(off)} = 1.5\text{ Vdc}$, $T_C = 100^\circ\text{C}$)	I_{CEV}	— —	— —	1 5	mAdc
Emitter Cutoff Current ($V_{EB} = 9\text{ Vdc}$, $I_C = 0$)	I_{EBO}	—	—	1	mAdc

SECOND BREAKDOWN

Second Breakdown Collector Current with base forward biased Clamped Inductive SOA with Base Reverse Biased	$I_{S/b}$ —	See Figure 1 See Figure 2			
---	----------------	------------------------------	--	--	--

***ON CHARACTERISTICS**

DC Current Gain ($I_C = 5\text{ Adc}$, $V_{CE} = 5\text{ Vdc}$) ($I_C = 8\text{ Adc}$, $V_{CE} = 5\text{ Vdc}$)	h_{FE}	8 6	— —	40 30	
Collector–Emitter Saturation Voltage ($I_C = 5\text{ Adc}$, $I_B = 1\text{ Adc}$) ($I_C = 8\text{ Adc}$, $I_B = 1.6\text{ Adc}$) ($I_C = 12\text{ Adc}$, $I_B = 3\text{ Adc}$) ($I_C = 8\text{ Adc}$, $I_B = 1.6\text{ Adc}$, $T_C = 100^\circ\text{C}$)	$V_{CE(sat)}$	— — — —	— — — —	1 1.5 3 2	Vdc
Base–Emitter Saturation Voltage ($I_C = 5\text{ Adc}$, $I_B = 1\text{ Adc}$) ($I_C = 8\text{ Adc}$, $I_B = 1.6\text{ Adc}$) ($I_C = 8\text{ Adc}$, $I_B = 1.6\text{ Adc}$, $T_C = 100^\circ\text{C}$)	$V_{BE(sat)}$	— — —	— — —	1.2 1.6 1.5	Vdc

DYNAMIC CHARACTERISTICS

Current–Gain — Bandwidth Product ($I_C = 500\text{ mAdc}$, $V_{CE} = 10\text{ Vdc}$, $f = 1\text{ MHz}$)	f_T	4	—	—	MHz
Output Capacitance ($V_{CB} = 10\text{ Vdc}$, $I_E = 0$, $f = 0.1\text{ MHz}$)	C_{ob}	—	180	—	pF

SWITCHING CHARACTERISTICS

Resistive Load (Table 1)						
Delay Time	$(V_{CC} = 125\text{ Vdc}$, $I_C = 8\text{ A}$, $I_{B1} = I_{B2} = 1.6\text{ A}$, $t_p = 25\text{ }\mu\text{s}$, Duty Cycle $\leq 1\%$)	t_d	—	0.06	0.1	μs
Rise Time		t_r	—	0.45	1	μs
Storage Time		t_s	—	1.3	3	μs
Fall Time		t_f	—	0.2	0.7	μs
Inductive Load, Clamped (Table 1, Figure 13)						
Voltage Storage Time	$(I_C = 8\text{ A}$, $V_{clamp} = 300\text{ Vdc}$, $I_{B1} = 1.6\text{ A}$, $V_{BE(off)} = 5\text{ Vdc}$, $T_C = 100^\circ\text{C}$)	t_{sv}	—	0.92	2.3	μs
Crossover Time		t_c	—	0.12	0.7	μs

*Pulse Test: Pulse Width = 300 μs , Duty Cycle = 2%.

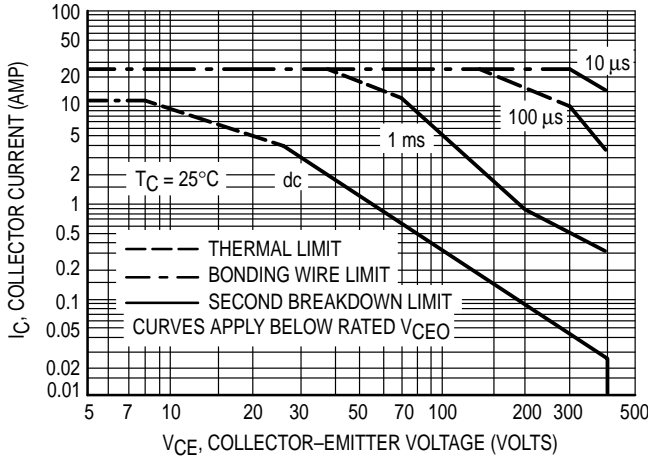

Figure 1. Forward Bias Safe Operating Area

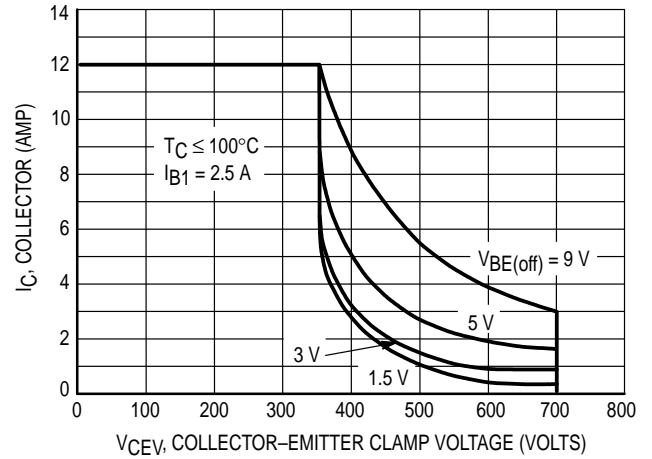

Figure 2. Reverse Bias Switching Safe Operating Area

The Safe Operating Area figures shown in Figures 1 and 2 are specified ratings for these devices under the test conditions shown.

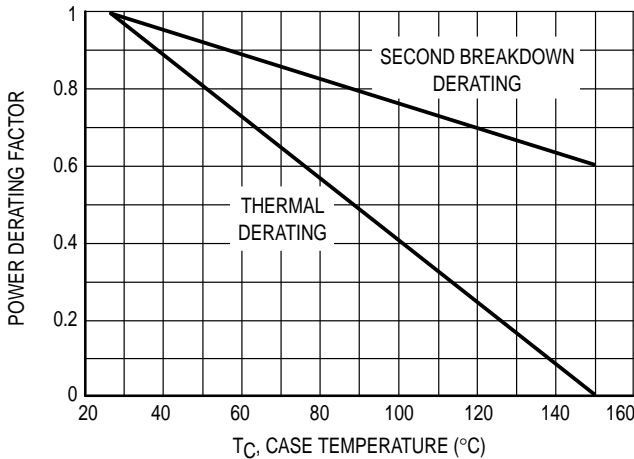

Figure 3. Forward Bias Power Derating

There are two limitations on the power handling ability of a transistor: average junction temperature and second breakdown. Safe operating area curves indicate $I_C - V_{CE}$ limits of the transistor that must be observed for reliable operation; i.e., the transistor must not be subjected to greater dissipation than the curves indicate.

The data of Figure 1 is based on $T_C = 25^\circ\text{C}$; $T_{J(pk)}$ is variable depending on power level. Second breakdown pulse limits are valid for duty cycles to 10% but must be derated when $T_C \geq 25^\circ\text{C}$. Second breakdown limitations do not derate the same as thermal limitations. Allowable current at the voltages shown on Figure 1 may be found at any case temperature by using the appropriate curve on Figure 3.

$T_{J(pk)}$ may be calculated from the data in Figure 4. At high case temperatures, thermal limitations will reduce the power that can be handled to values less than the limitations imposed by second breakdown. Use of reverse biased safe operating area data (Figure 2) is discussed in the applications information section.

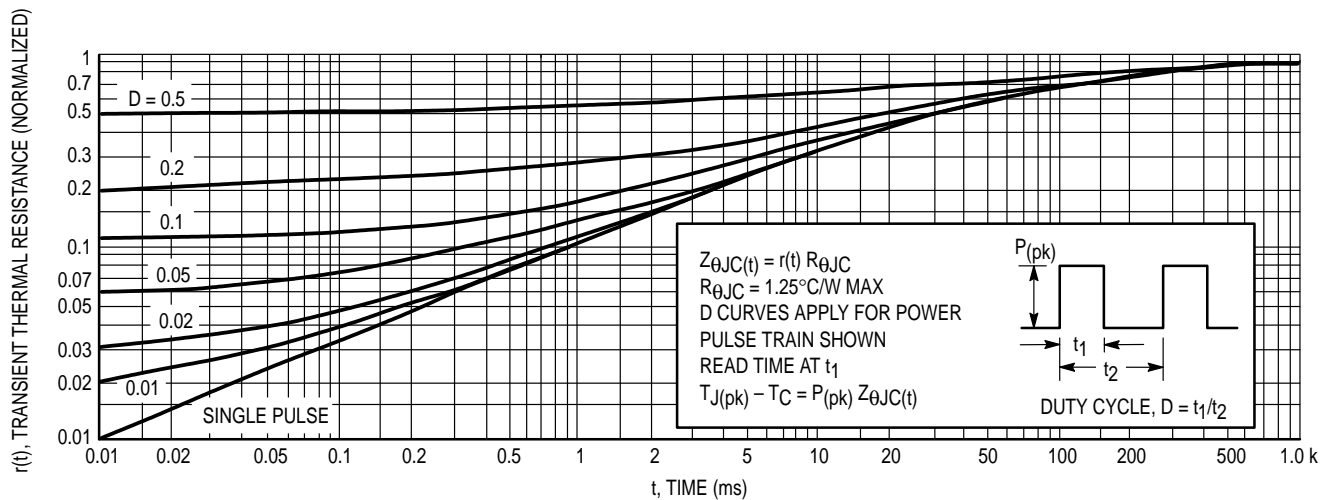

Figure 4. Typical Thermal Response [$Z_{\theta JC}(t)$]

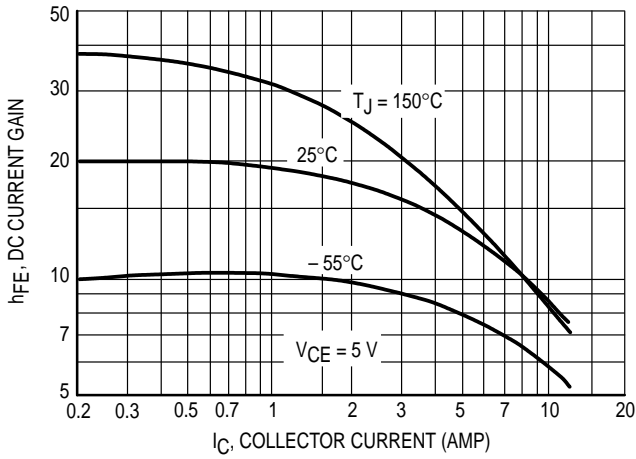

Figure 5. DC Current Gain

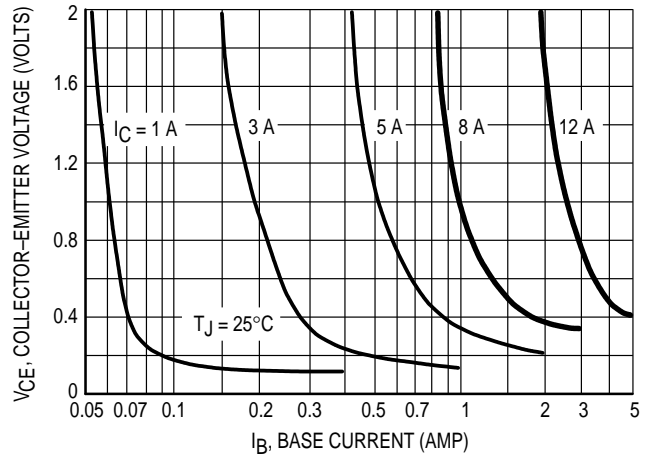

Figure 6. Collector Saturation Region

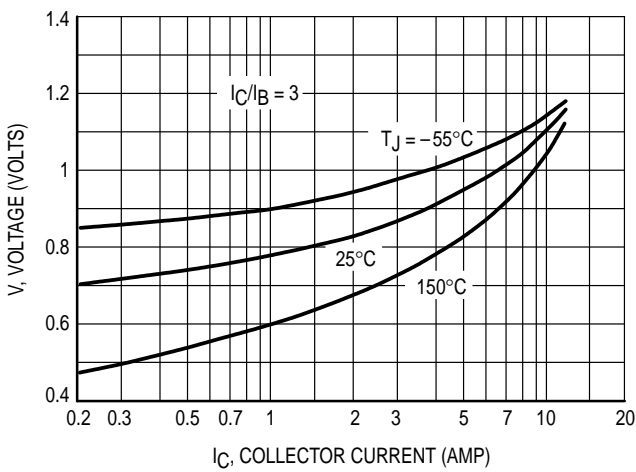

Figure 7. Base-Emitter Saturation Voltage

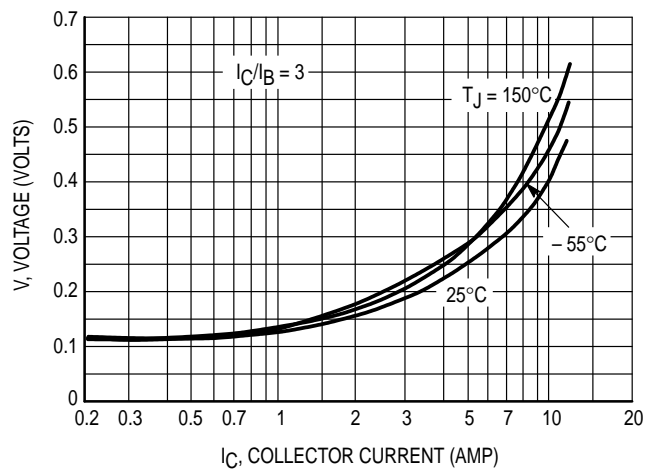

Figure 8. Collector-Emitter Saturation Voltage

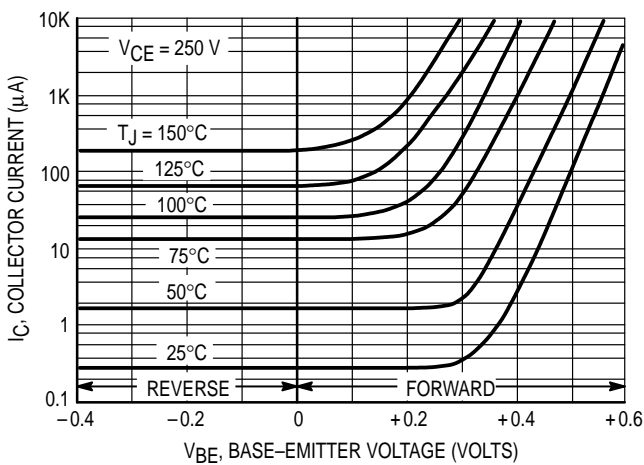

Figure 9. Collector Cutoff Region

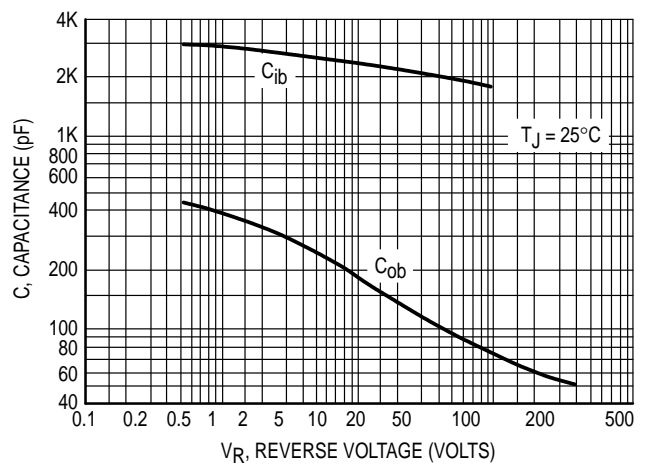

Figure 10. Capacitance

Table 1. Test Conditions for Dynamic Performance

REVERSE BIAS SAFE OPERATING AREA AND INDUCTIVE SWITCHING		RESISTIVE SWITCHING
TEST CIRCUITS	<p>DUTY CYCLE $\leq 10\%$ $t_r, t_f \leq 10$ ns</p> <p>NOTE PW and V_{CC} Adjusted for Desired I_C R_B Adjusted for Desired I_{B1}</p>	
CIRCUIT VALUES	<p>Coil Data: Ferroxcube Core #6656 Full Bobbin (~16 Turns) #16</p> <p>GAP for 200 μH/20 A $L_{coil} = 200 \mu$H</p> <p>$V_{CC} = 20$ V $V_{clamp} = 300$ Vdc</p>	<p>$V_{CC} = 125$ V $R_C = 15 \Omega$ $D1 = 1N5820$ or Equiv. $R_B = \Omega$</p>
TEST WAVEFORMS	<p>OUTPUT WAVEFORMS</p> <p>t_1 ADJUSTED TO OBTAIN I_C</p> $t_1 \approx \frac{L_{coil} (I_{CM})}{V_{CC}}$ $t_2 \approx \frac{L_{coil} (I_{CM})}{V_{clamp}}$ <p>Test Equipment Scope—Tektronics 475 or Equivalent</p>	<p>$t_r, t_f < 10$ ns Duty Cycle = 1.0% R_B and R_C adjusted for desired I_B and I_C</p>

APPLICATIONS INFORMATION FOR SWITCHMODE SPECIFICATIONS

INTRODUCTION

The primary considerations when selecting a power transistor for SWITCHMODE applications are voltage and current ratings, switching speed, and energy handling capability. In this section, these specifications will be discussed and related to the circuit examples illustrated in Table 2.(1)

VOLTAGE REQUIREMENTS

Both blocking voltage and sustaining voltage are important in SWITCHMODE applications.

Circuits B and C in Table 2 illustrate applications that require high blocking voltage capability. In both circuits the switching transistor is subjected to voltages substantially higher than V_{CC} after the device is completely off (see load line diagrams at $I_C = I_{leakage} \approx 0$ in Table 2). The blocking capability at this point depends on the base to emitter conditions and the device junction temperature. Since the highest device capability occurs when the base to emitter junction is reverse biased (V_{CEV}), this is the recommended and specified use condition. Maximum I_{CEV} at rated V_{CEV} is specified at a relatively low reverse bias (1.5 Volts) both at 25°C and

100°C. Increasing the reverse bias will give some improvement in device blocking capability.

The sustaining or active region voltage requirements in switching applications occur during turn-on and turn-off. If the load contains a significant capacitive component, high current and voltage can exist simultaneously during turn-on and the pulsed forward bias SOA curves (Figure 1) are the proper design limits.

For inductive loads, high voltage and current must be sustained simultaneously during turn-off, in most cases, with the base to emitter junction reverse biased. Under these conditions the collector voltage must be held to a safe level at or below a specific value of collector current. This can be accomplished by several means such as active clamping, RC snubbing, load line shaping, etc. The safe level for these devices is specified as a Reverse Bias Safe Operating Area (Figure 2) which represents voltage-current conditions that can be sustained during reverse biased turn-off. This rating is verified under clamped conditions so that the device is never subjected to an avalanche mode.

(1) For detailed information on specific switching applications, see Motorola Application Notes AN-719, AN-767.

VOLTAGE REQUIREMENTS (continued)

In the four application examples (Table 2) load lines are shown in relation to the pulsed forward and reverse biased SOA curves.

In circuits A and D, inductive reactance is clamped by the diodes shown. In circuits B and C the voltage is clamped by the output rectifiers, however, the voltage induced in the primary leakage inductance is not clamped by these diodes and could be large enough to destroy the device. A snubber network or an additional clamp may be required to keep the turn-off load line within the Reverse Bias SOA curve.

Load lines that fall within the pulsed forward biased SOA curve during turn-on and within the reverse bias SOA curve during turn-off are considered safe, with the following assumptions:

- (1) The device thermal limitations are not exceeded.
- (2) The turn-on time does not exceed 10 μ s (see standard pulsed forward SOA curves in Figure 1).
- (3) The base drive conditions are within the specified limits shown on the Reverse Bias SOA curve (Figure 2).

CURRENT REQUIREMENTS

An efficient switching transistor must operate at the required current level with good fall time, high energy handling

capability and low saturation voltage. On this data sheet, these parameters have been specified at 8 amperes which represents typical design conditions for these devices. The current drive requirements are usually dictated by the $V_{CE(sat)}$ specification because the maximum saturation voltage is specified at a forced gain condition which must be duplicated or exceeded in the application to control the saturation voltage.

SWITCHING REQUIREMENTS

In many switching applications, a major portion of the transistor power dissipation occurs during the fall time (t_{fi}). For this reason considerable effort is usually devoted to reducing the fall time. The recommended way to accomplish this is to reverse bias the base-emitter junction during turn-off. The reverse biased switching characteristics for inductive loads are discussed in Figure 11 and Table 3 and resistive loads in Figures 13 and 14. Usually the inductive load component will be the dominant factor in SWITCHMODE applications and the inductive switching data will more closely represent the device performance in actual application. The inductive switching characteristics are derived from the same circuit used to specify the reverse biased SOA curves, (See Table 1) providing correlation between test procedures and actual use conditions.

RESISTIVE SWITCHING PERFORMANCE

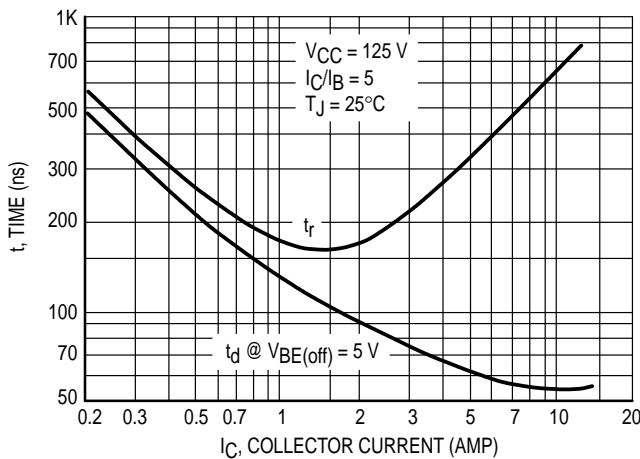

Figure 11. Turn-On Time

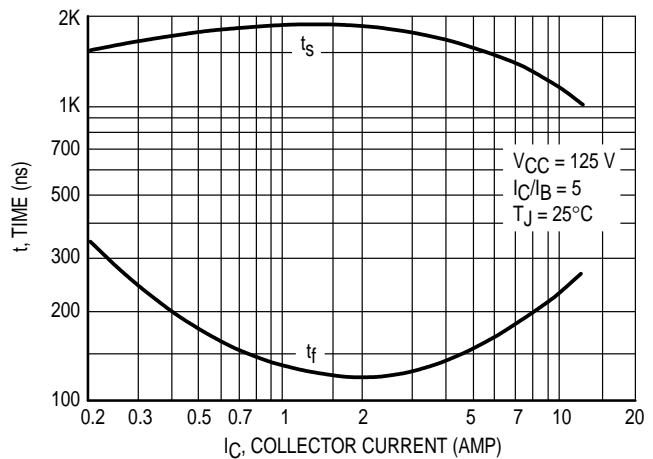

Figure 12. Turn-Off Time

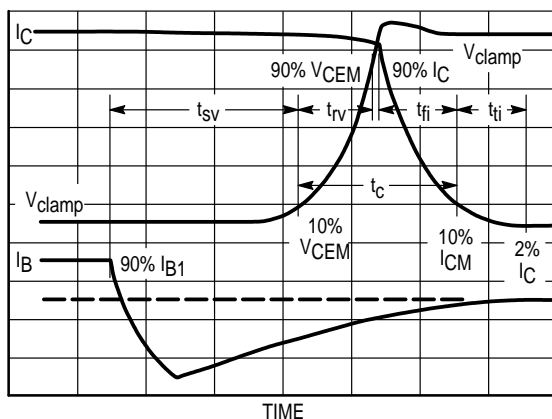

Figure 13. Inductive Switching Measurements

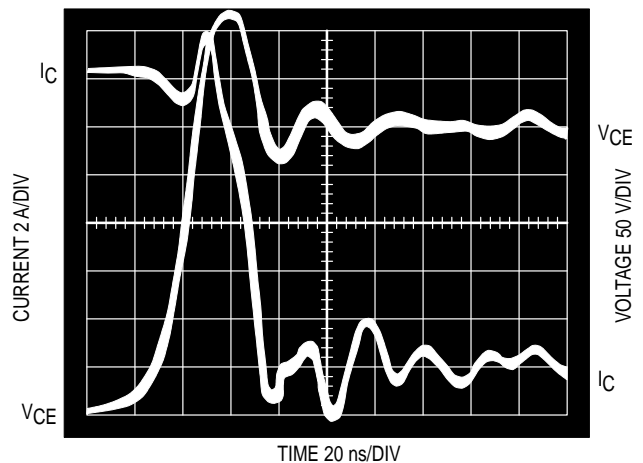

Figure 14. Typical Inductive Switching Waveforms (at 300 V and 12 A with $I_{B1} = 2.4$ A and $V_{BE(off)} = 5$ V)

Table 2. Applications Examples of Switching Circuits

CIRCUIT	LOAD LINE DIAGRAMS	TIME DIAGRAMS
<p>SERIES SWITCHING REGULATOR</p> 		
<p>RINGING CHOKE INVERTER</p> 		
<p>PUSH-PULL INVERTER/CONVERTER</p> 		
<p>SOLENOID DRIVER</p> 		

Table 3. Typical Inductive Switching Performance

I_C AMP	T_C °C	t_{sv} ns	t_{rv} ns	t_{fi} ns	t_{tj} ns	t_c ns
3	25	770	100	150	200	240
	100	1000	230	160	200	320
5	25	630	72	26	10	100
	100	820	100	55	30	180
8	25	720	55	27	2	77
	100	920	70	50	8	120
12	25	640	20	17	2	41
	100	800	32	24	4	54

NOTE: All Data recorded In the Inductive Switching Circuit In Table 1.

SWITCHING TIME NOTES

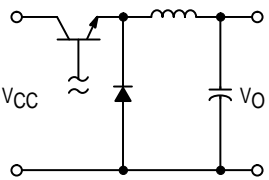
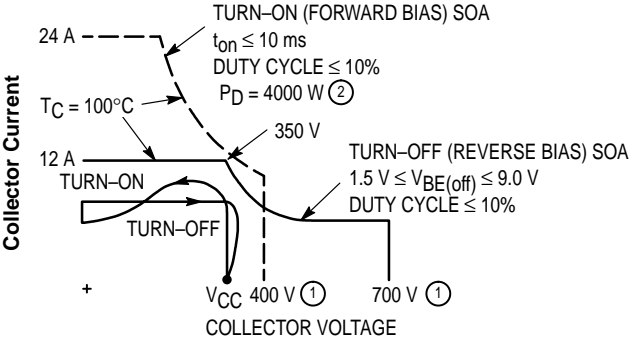
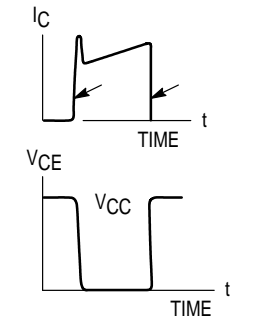
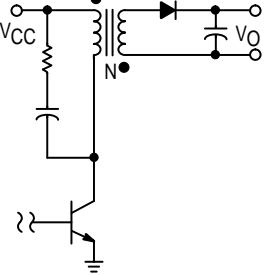
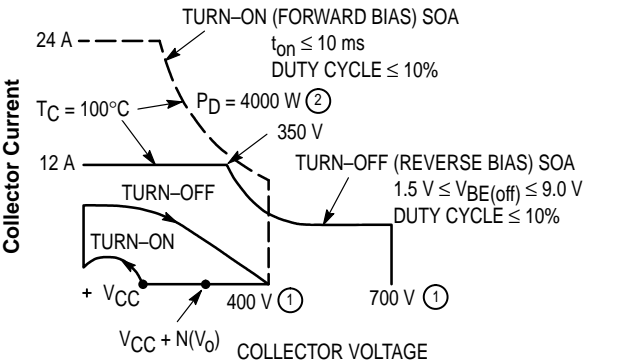
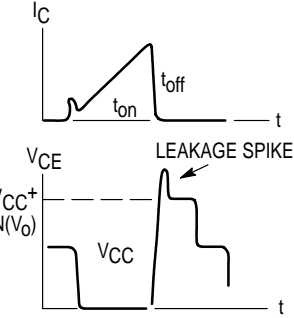
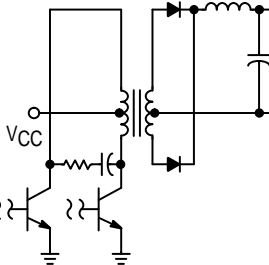
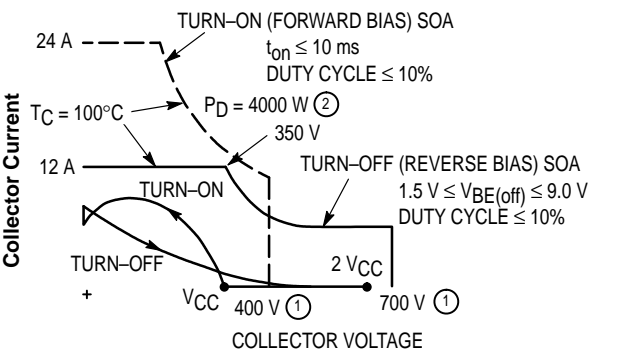
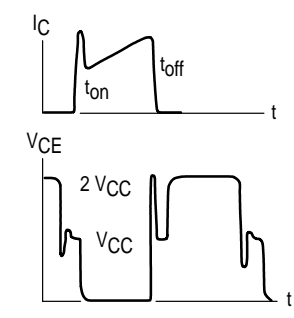
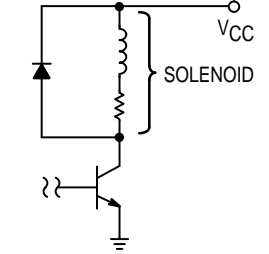
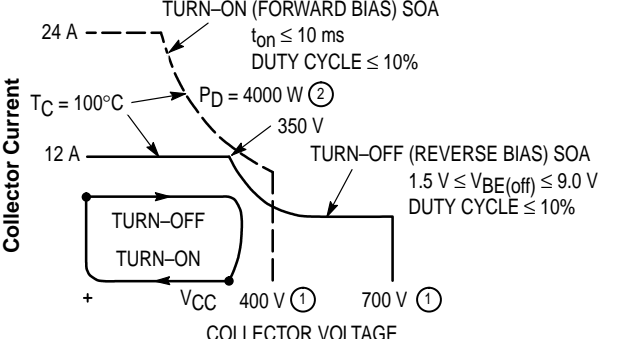
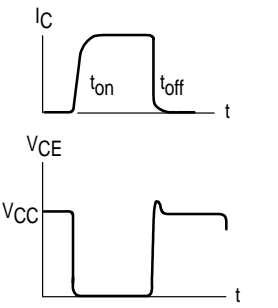
In resistive switching circuits, rise, fall, and storage times have been defined and apply to both current and voltage waveforms since they are in phase. However, for inductive loads which are common to SWITCHMODE power supplies and hammer drivers, current and voltage waveforms are not in phase. Therefore, separate measurements must be made on each waveform to determine the total switching time. For this reason, the following new terms have been defined.

t_{sv} = Voltage Storage Time, 90% I_{B1} to 10% V_{CEM}

t_{rv} = Voltage Rise Time, 10–90% V_{CEM}

t_{fi} = Current Fall Time, 90–10% I_{CM}

t_{tj} = Current Tail, 10–2% I_{CM}

t_c = Crossover Time, 10% V_{CEM} to 10% I_{CM}

An enlarged portion of the turn-off waveforms is shown in Figure 13 to aid in the visual identity of these terms.

For the designer, there is minimal switching loss during storage time and the predominant switching power losses occur during the crossover interval and can be obtained using the standard equation from AN-222:

$$P_{SWT} = 1/2 V_{CC} I_C (t_c) f$$

Typical inductive switching waveforms are shown in Figure 14. In general, $t_{rv} + t_{fi} \approx t_c$. However, at lower test currents this relationship may not be valid.

As is common with most switching transistors, resistive switching is specified at 25°C and has become a benchmark for designers. However, for designers of high frequency converter circuits, the user oriented specifications which make this a "SWITCHMODE" transistor are the inductive switching speeds (t_c and t_{sv}) which are guaranteed at 100°C.

PACKAGE DIMENSIONS

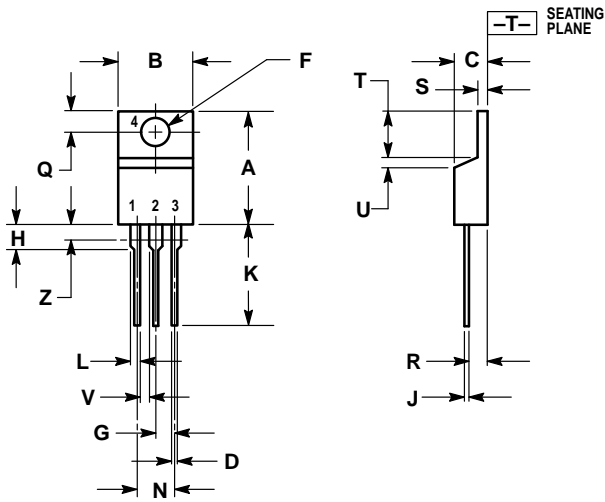

- NOTES:
1. DIMENSIONING AND TOLERANCING PER ANSI Y14.5M, 1982.
 2. CONTROLLING DIMENSION: INCH.
 3. DIMENSION Z DEFINES A ZONE WHERE ALL BODY AND LEAD IRREGULARITIES ARE ALLOWED.

DIM	INCHES		MILLIMETERS	
	MIN	MAX	MIN	MAX
A	0.570	0.620	14.48	15.75
B	0.380	0.405	9.66	10.28
C	0.160	0.190	4.07	4.82
D	0.025	0.035	0.64	0.88
F	0.142	0.147	3.61	3.73
G	0.095	0.105	2.42	2.66
H	0.110	0.155	2.80	3.93
J	0.018	0.025	0.46	0.64
K	0.500	0.562	12.70	14.27
L	0.045	0.060	1.15	1.52
N	0.190	0.210	4.83	5.33
Q	0.100	0.120	2.54	3.04
R	0.080	0.110	2.04	2.79
S	0.045	0.055	1.15	1.39
T	0.235	0.255	5.97	6.47
U	0.000	0.050	0.00	1.27
V	0.045	—	1.15	—
Z	—	0.080	—	2.04

- STYLE 1:
 PIN 1. BASE
 2. COLLECTOR
 3. EMITTER
 4. COLLECTOR

CASE 221A-06
 TO-220AB
 ISSUE Y

Motorola reserves the right to make changes without further notice to any products herein. Motorola makes no warranty, representation or guarantee regarding the suitability of its products for any particular purpose, nor does Motorola assume any liability arising out of the application or use of any product or circuit, and specifically disclaims any and all liability, including without limitation consequential or incidental damages. "Typical" parameters can and do vary in different applications. All operating parameters, including "Typicals" must be validated for each customer application by customer's technical experts. Motorola does not convey any license under its patent rights nor the rights of others. Motorola products are not designed, intended, or authorized for use as components in systems intended for surgical implant into the body, or other applications intended to support or sustain life, or for any other application in which the failure of the Motorola product could create a situation where personal injury or death may occur. Should Buyer purchase or use Motorola products for any such unintended or unauthorized application, Buyer shall indemnify and hold Motorola and its officers, employees, subsidiaries, affiliates, and distributors harmless against all claims, costs, damages, and expenses, and reasonable attorney fees arising out of, directly or indirectly, any claim of personal injury or death associated with such unintended or unauthorized use, even if such claim alleges that Motorola was negligent regarding the design or manufacture of the part. Motorola and  are registered trademarks of Motorola, Inc. Motorola, Inc. is an Equal Opportunity/Affirmative Action Employer.

How to reach us:

USA / EUROPE: Motorola Literature Distribution;
P.O. Box 20912; Phoenix, Arizona 85036. 1-800-441-2447

JAPAN: Nippon Motorola Ltd.; Tatsumi-SPD-JLDC, Toshikatsu Otsuki,
6F Seibu-Butsuryu-Center, 3-14-2 Tatsumi Koto-Ku, Tokyo 135, Japan. 03-3521-8315

MFAX: RMFAX0@email.sps.mot.com – TOUCHTONE (602) 244-6609
INTERNET: <http://Design-NET.com>

HONG KONG: Motorola Semiconductors H.K. Ltd.; 8B Tai Ping Industrial Park,
51 Ting Kok Road, Tai Po, N.T., Hong Kong. 852-26629298

