



MAX8717 Evaluation Kit

General Description

The MAX8717 evaluation kit (EV kit) demonstrates the MAX8717's standard application circuit. This dual-PWM synchronous DC-DC converter steps down high-voltage batteries and/or AC adapters, generating main supplies for notebook computers.

The MAX8717 EV kit provides dual 5V and 3.3V output voltages from the 6V to 24V battery input range. It delivers up to 5A output current for the 5V output and 5A for the 3.3V output with 95% efficiency. The EV kit operates at 300kHz switching frequency and has superior line- and load-transient response.

This EV kit is a fully assembled and tested circuit board. Both outputs are adjustable between 1.0V and 5.5V by changing feedback resistors R20, R21, R24, and R26.

Features

- ◆ 6V to 24V Input Voltage Range
- ◆ Output Voltages
 - 3.3V at 5A (Adjustable from 1.0V to 5.5V)
 - 5.0V at 5A (Adjustable from 1.0V to 5.5V)
- ◆ 300kHz Switching Frequency (Selectable 200kHz/300kHz/500kHz)
- ◆ Independently Selectable PWM, Skip, and Low-Noise Mode Operation
- ◆ Independent Power-Good Outputs
- ◆ Low-Profile Components
- ◆ Fully Assembled and Tested

Ordering Information

PART	TEMP RANGE	IC PACKAGE
MAX8717EVKIT	0°C to +70°C	28 Thin QFN 5mm x 5mm

Component List

DESIGNATION	QTY	DESCRIPTION
C1, C19	0	Not installed (E case)
C2	1	220 μ F, 6.3V, 25m Ω low-ESR capacitor (D case) Sanyo 6TPE220M Kemet T520V227M006ASE025
C3	1	150 μ F, 6.3V, 25m Ω low-ESR capacitor (D case) Sanyo 6TPE150M Kemet T520D157M006ASE025
C4, C7	0	Not installed (1812)
C5, C6	2	10 μ F \pm 20%, 25V X5R ceramic capacitors (1812) Taiyo Yuden TMK432BJ106KM or TDK C4532X5R1E106M
C8, C9	2	0.1 μ F \pm 10%, 50V X7R ceramic capacitors (0603) Murata GRM188R71H104K or equivalent
C12, C15	2	1 μ F \pm 20%, 10V X5R ceramic capacitors (0805) Taiyo Yuden LMK212BJ105KG or TDK C2012X7R1C105MKT

DESIGNATION	QTY	DESCRIPTION
C13, C20, C21, C26	0	Not installed (0603)
C14	1	0.22 μ F, 16V X5R ceramic capacitor (0805) Taiyo Yuden EMK212BJ224KG
C27, C28	2	10 μ F \pm 20%, 6.3V X5R ceramic capacitors (0805) TDK C2012X5R0J106M or Taiyo Yuden AMK212BJ106MG
D1, D2	2	1A, 30V Schottky diodes Nihon EP10QY03 or Toshiba CRS02
D3, D4	2	100mA, 30V Schottky diodes (SOT23) (top mark: D95) Central Semiconductor CMPSH-3
JU1, JU2	2	3-pin headers
JU3, JU4, JU5	3	4-pin headers
JU1 (1, 2), JU2 (1, 2), JU3 (1, 3), JU4 (1, 2), JU5 (1, 2)	5	Shunts

Evaluates: MAX8717

MAX8717 Evaluation Kit

Component List (continued)

DESIGNATION	QTY	DESCRIPTION
L1, L2	2	5.7 μ H, 5.8A, 10.3m Ω power inductors Sumida CDEP105-5R7NC, or Sumida CDRH127/LD-5R8NC, or TDK RLF12560T-5R6N9R2
N1, N3	2	n-channel MOSFETs (8-pin SO) Fairchild FDS6612A
N2, N4	2	n-channel MOSFETs (8-pin SO) Fairchild FDS6670A
R1, R2	2	0.007 Ω \pm 1%, 1/2W resistors (2010) IRC LR2010-01-R0007-F or Dale WSL-2010-R0007F

DESIGNATION	QTY	DESCRIPTION
R3–R6, R22, R23	0	Not installed (short PC trace) (0603)
R7, R8	2	100k Ω \pm 5% resistors (0603)
R9	1	20 Ω \pm 5% resistor (0805)
R10, R11, R19, R25	4	0 Ω \pm 1% resistors (0603)
R15–R18, R20, R21, R24, R26, R29, R32	0	Not installed (0603)
U1	1	MAX8717ETL (28-pin thin QFN 5mm x 5mm)
None	1	MAX8717 PC board

Component Suppliers

SUPPLIER	PHONE	FAX	WEBSITE
Central Semiconductor	631-435-1110	631-435-1824	www.centralsemi.com
Dale-Vishay	402-564-3131	402-563-6296	www.vishay.com
Fairchild	888-522-5372	—	www.fairchildsemi.com
IRC	361-992-7900	361-992-3377	www.irctt.com
Kemet	864-963-6300	864-963-6322	www.kemet.com
Murata	770-436-1300	770-436-3636	www.murata.com
Nihon	847-843-7500	847-843-2798	www.niec.co.jp
Sanyo	619-661-6835	619-661-1055	www.sanyodevice.com
Sumida	847-545-6700	847-545-6720	www.sumida.com
Taiyo Yuden	800-348-2496	847-925-0899	www.t-yuden.com
TDK	847-803-6100	847-390-4405	www.component.tdk.com
Toshiba	408-526-2459	408-526-2426	www.toshiba.com

Note: Indicate that you are using the MAX8717 when contacting these component suppliers.

Quick Start

Recommended Equipment

- 6V to 24V, power supply, battery, or notebook AC adapter
- DC bias power supply, 5V at 100mA
- Dummy loads capable of sinking 5A
- Digital multimeters (DMMs)
- 100MHz dual-trace oscilloscope

Procedure

- 1) Ensure that the circuit is connected correctly to the supplies and dummy loads prior to applying any power.
- 2) Verify that the shunts are across:
 - a) JU1 pins 1 and 2 (ON1 high, OUT1 (3.3V) enabled)
 - b) JU2 pins 1 and 2 (ON2 high, OUT2 (5.0V) enabled)
 - c) JU3 pins 1 and 3 (300kHz switching frequency)

MAX8717 Evaluation Kit

Evaluates: MAX8717

- d) JU4 pins 1 and 2 ($\overline{\text{SKIP1}}$ high, OUT1 in forced-PWM mode)
 - e) JU5 pins 1 and 2 ($\overline{\text{SKIP2}}$ high, OUT2 in forced-PWM mode)
- 3) Turn on input power VIN prior to +5V bias power; otherwise, the output UVLO timer times out and the FAULT latch is set, disabling the regulator outputs until +5V power is cycled or ON1/ON2 is toggled.
 - 4) Verify that the output voltages are $V_{\text{OUT1}} = 3.3\text{V}$ and $V_{\text{OUT2}} = 5.0\text{V}$.

Table 1. Jumper JU1 Functions (Output Voltage OUT1 Control)

JU1	ON1 PIN	OUT1
1 and 2 (default)	Connected to VCC.	OUT1 is enabled, $V_{\text{OUT1}} = 3.3\text{V}$.
2 and 3	Connected to GND.	OUT1 is disabled.
Not installed	ON1 must be driven by an external signal connected to ON1 pad.	OUT1 operation depends on the external ON1 signal levels.

Table 2. Jumper JU2 Functions (Output Voltage OUT2 Control)

JU2	ON2 PIN	OUT2
1 and 2 (default)	Connected to VCC.	OUT2 is enabled, $V_{\text{OUT2}} = 5.0\text{V}$.
2 and 3	Connected to GND.	OUT2 is disabled.
Not installed	ON2 must be driven by an external signal connected to ON2 pad.	OUT2 operation depends on the external ON2 signal levels.

Table 3. Jumpers JU3 Functions (Switching-Frequency Selection)

JU3	FSEL PIN	FREQUENCY (kHz)
1 and 2	Connected to VCC.	500
1 and 3 (default)	Connected to REF.	300 (as shipped)
1 and 4	Connected to GND.	200

Note: Do not change the operating frequency without first recalculating component values. The frequency has a significant effect on preferred inductor value, peak current-limit level, MOSFET heating, PFM/PWM switchover point, output noise, efficiency, and other critical parameters.

Table 4. Jumper JU4 Functions (Low-Noise Mode Control for OUT1)

JU4	$\overline{\text{SKIP1}}$ PIN	OPERATIONAL MODE
1 and 2 (default)	Connected to VCC.	OUT1 is in forced-PWM mode (fixed frequency).
1 and 3	Connected to REF.	OUT1 is in low-noise mode.
1 and 4	Connected to GND.	OUT1 is in pulse-skipping mode.

Table 5. Jumper JU5 Functions (Low-Noise Mode Control for OUT2)

JU5	$\overline{\text{SKIP2}}$ PIN	OPERATIONAL MODE
1 and 2 (default)	Connected to VCC.	OUT2 is in forced-PWM mode (fixed frequency).
1 and 3	Connected to REF.	OUT2 is in low-noise mode.
1 and 4	Connected to GND.	OUT2 is in pulse-skipping mode.

Detailed Description

Jumper Setting

Evaluating Other Output Voltages

The MAX8717 provides a fixed 3.3V output (OUT1) when FB1 is connected to VCC ($R_{25} = 0$) and a fixed 5.0V output (OUT2) when FB2 is connected to VCC ($R_{19} = 0$).

OUT1 and OUT2 can also be adjusted from 1.0V to 5.5V by using a resistive voltage-divider formed by R_{24} , R_{26} ($R_{25} = \text{open}$), and R_{20} , R_{21} ($R_{19} = \text{open}$). The MAX8717 regulates FB1, FB2 to a fixed reference voltage (1.0V).

The adjusted output voltages are:

$$V_{\text{OUT1}} = V_{\text{FB1}}(1 + R_{24}/R_{26})$$

where $V_{\text{FB1}} = 1.0\text{V}$;

$$V_{\text{OUT2}} = V_{\text{FB2}}(1 + R_{20}/R_{21})$$

where $V_{\text{FB2}} = 1.0\text{V}$.

Two 330pF to 1000pF feed-forward bypass capacitors (C13, C26) reduce duty-cycle jitter and feedback noise.

Refer to the MAX8716/MAX8717/MAX8757 data sheet for selection of output capacitors and inductor values for different output voltages.

MAX8717 Evaluation Kit

Evaluates: MAX8717

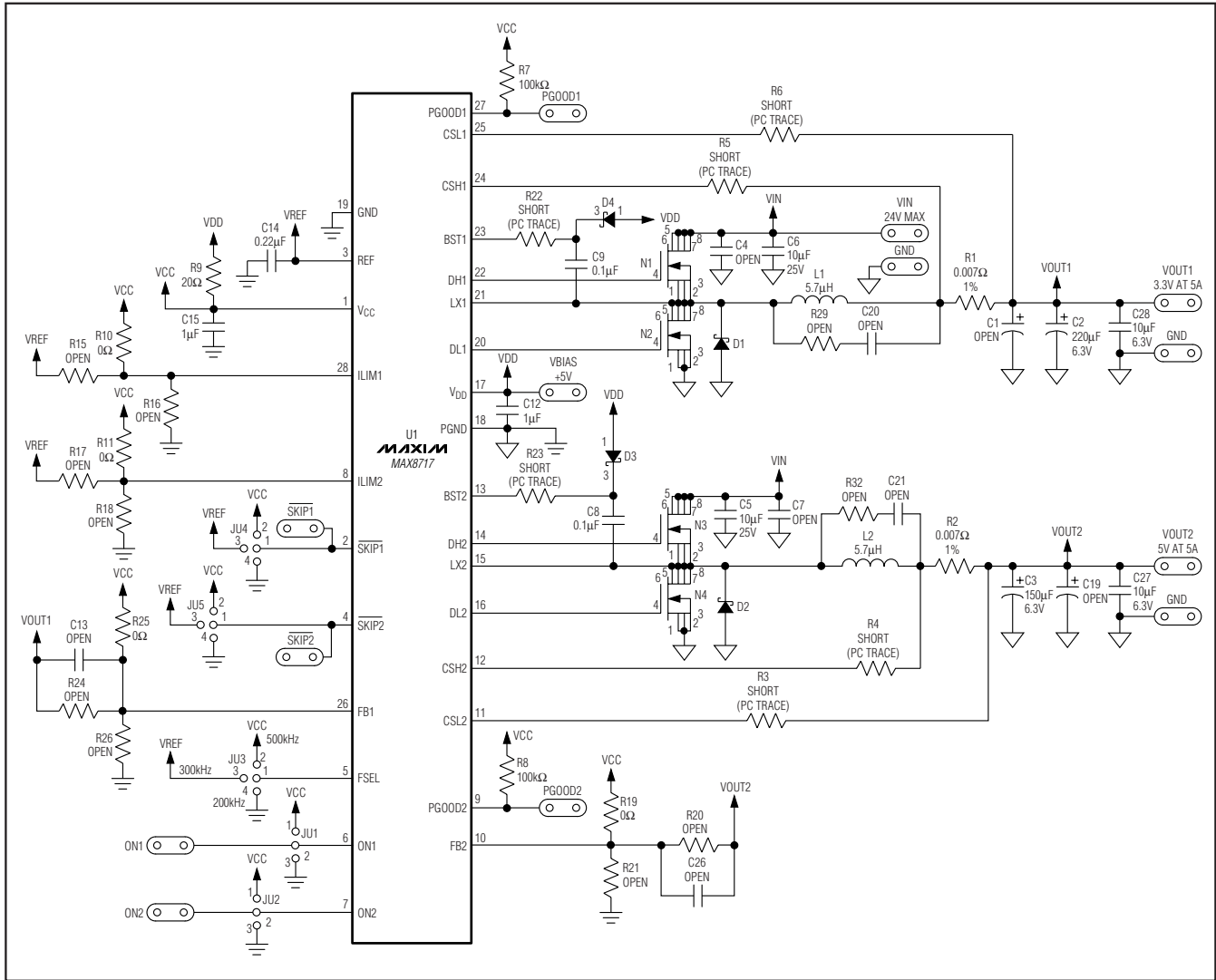

Figure 1. MAX8717 Schematic

MAX8717 Evaluation Kit

Evaluates: MAX8717

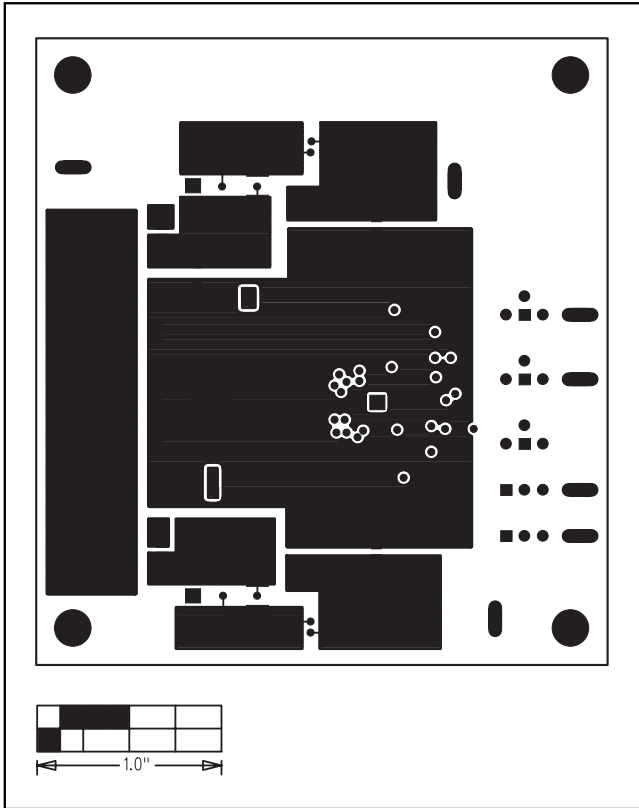

Figure 2. MAX8717 EV Kit Component Placement Guide—Component Side

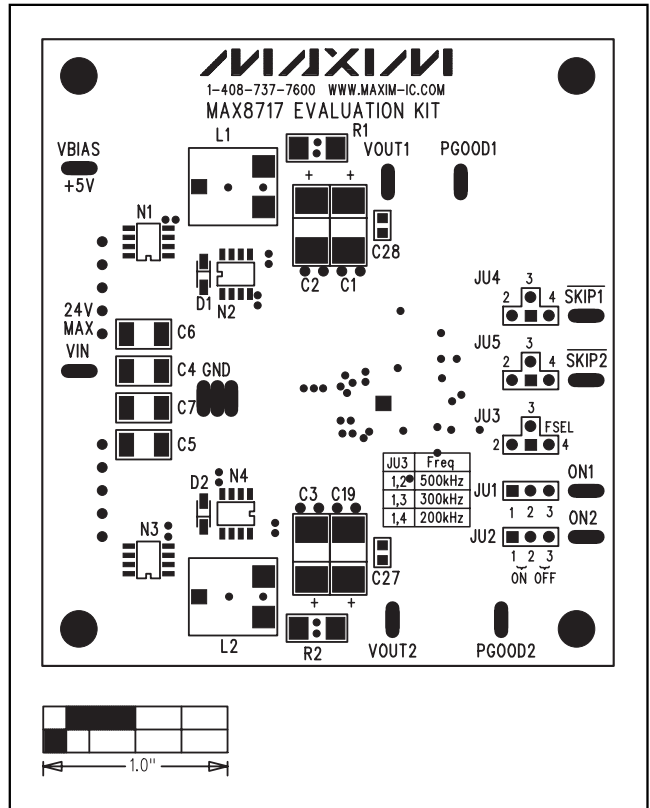

Figure 3. MAX8717 EV Kit PC Board Layout—Top Silkscreen

MAX8717 Evaluation Kit

Evaluates: MAX8717

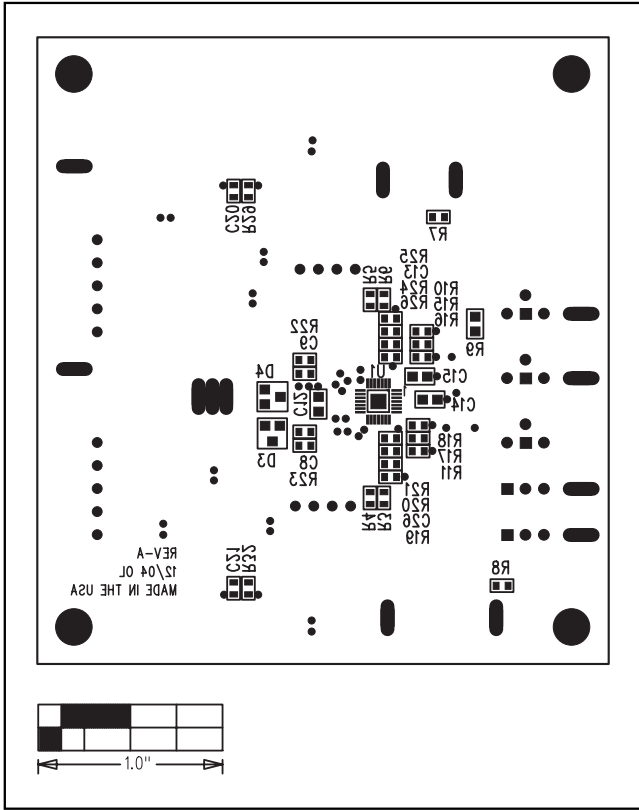

Figure 4. MAX8717 EV Kit PC Board Layout—Bottom Silkscreen

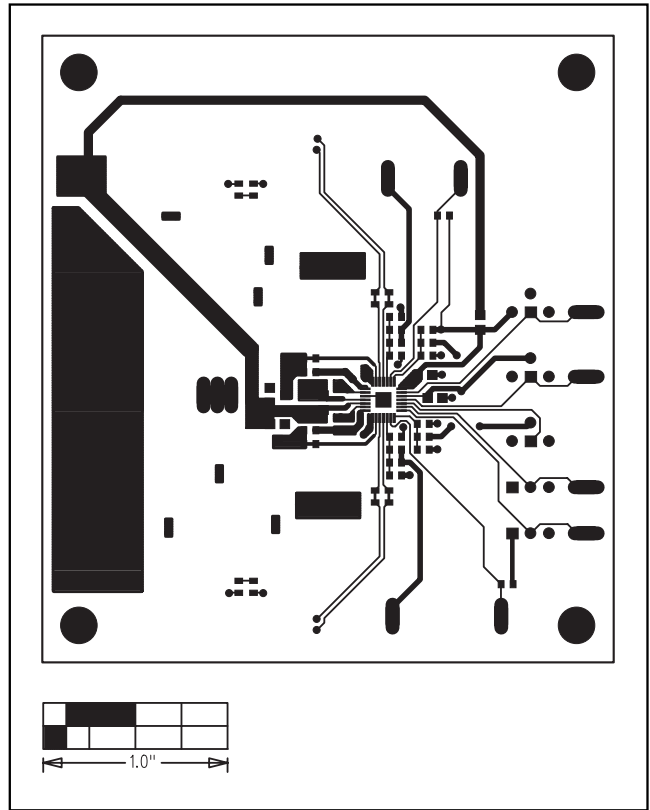

Figure 5. MAX8717 EV Kit PC Board Layout—Solder Side

MAX8717 Evaluation Kit

Evaluates: MAX8717

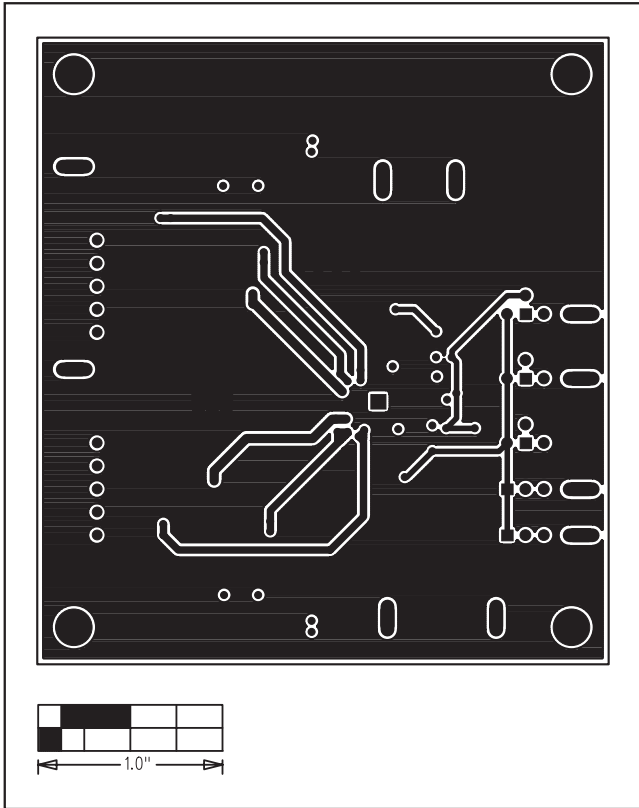

Figure 6. MAX8717 EV Kit PC Board Layout—PGND/Signal Layer 2

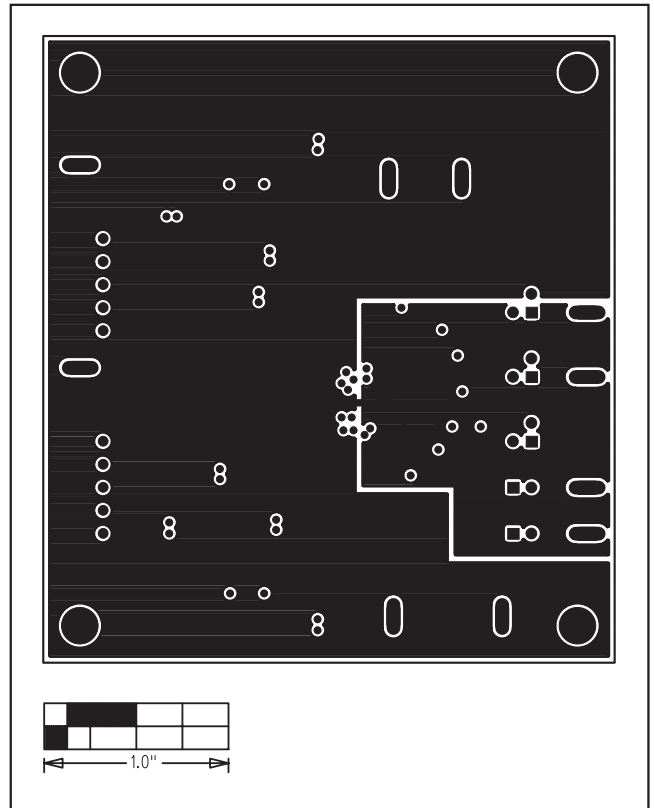

Figure 7. MAX8717 EV Kit PC Board Layout—PGND/AGND Layer 3

Maxim cannot assume responsibility for use of any circuitry other than circuitry entirely embodied in a Maxim product. No circuit patent licenses are implied. Maxim reserves the right to change the circuitry and specifications without notice at any time.

Maxim Integrated Products, 120 San Gabriel Drive, Sunnyvale, CA 94086 408-737-7600 _____ 7