



MAX4455 Evaluation Kit/Evaluation System

General Description

The MAX4455 evaluation kit (EV kit) is an assembled and tested circuit board that demonstrates the MAX4455 arbitrary graphics on-screen display video generator. Windows® 98 software provides a handy user interface to exercise the features of the MAX4455. (Windows 2000 is supported, but at a severely reduced data rate.)

Order the complete evaluation system (EV system) (MAX4455EVSYS) for comprehensive evaluation of the MAX4455 using a PC and the recommended crosspoint switch. A bidirectional parallel port is required. Order the EV kit (MAX4455EVKIT) for use with other user-defined external solutions.

Windows is a registered trademark of Microsoft Corp.

MAX4455EVSYS Component List

PART	QTY	DESCRIPTION
MAX4455EVKIT	1	8-channel on-screen display
MAX4358EVKIT	1	32 × 16 crosspoint switch

Features

- ◆ Character Generation Using Fonts from Host PC
- ◆ Demonstration Software and Test Patterns Included
- ◆ Proven PC Board Layout
- ◆ Convenient On-Board Test Points
- ◆ Fully Assembled and Tested

Ordering Information

PART	TEMP RANGE	DESCRIPTION
MAX4455EVSYS	0°C to +70°C	Complete system
MAX4455EVKIT	0°C to +70°C	Requires user-supplied fast mux switch*

*Refer to the MAX4455 data sheet.

EV Kit Component List

DESIGNATION	QTY	DESCRIPTION
C1–C17, C19, C21, C22, C24–C29, C31, C48	28	0.1µF ±10%, 10V ceramic capacitors (0402)
C18, C23, C30, C57	4	100µF ±20%, 6.3V ceramic capacitors (2220) TDK C575X5R0J107M
C20	1	0.01µF ceramic capacitor (1206)
C32, C35, C36, C39, C40, C43, C44, C47	8	470pF ±10%, 50V ceramic capacitors (0402)
C33, C34, C37, C38, C41, C42, C45, C46	8	0.047µF ±10%, 10V ceramic capacitors (0402)
C49–C56	0	Leave open
J5	1	2 × 25 right-angle header
J6	1	2 × 13 right-angle header
JU1–JU8	0	Leave open
JU9	1	2-pin jumper
JU9	1	Shunt
R1	1	10kΩ ±1% resistor (1/4W axial leaded)

DESIGNATION	QTY	DESCRIPTION
R2–R9	8	75Ω ±1% SMT resistors (0402)
R10–R17	8	430Ω ±5% SMT resistors (0402)
TB1	2	6-position terminal blocks
U1	1	MAX4455ECQ
U2	1	Dynamic RAM Micron MT48LC1M16A1TG-7S
U3	1	MAX8867EUK33
U4	1	Full-size crystal oscillator ICM International Crystal Manufacturing Corp., Inc. Catalog IT1100FSS, custom 40.5MHz, 3.3VDC
U4, Y1	8	Socket pins
VSYNC0–VSYNC7	8	BNC female jacks
Y1	0	Leave open
None	1	PC board
None	1	MAX4455 EV kit software CD-ROM
None	1	MAX4455 data sheet
None	1	MAX4455 EV kit data sheet
None	1	DB25 IDC plug connector with 6ft ribbon cable Digi-Key M7PXG-2SO6J or equivalent

Evaluate: MAX4455



MAX4455 Evaluation Kit/Evaluation System

Quick Start

Recommended Equipment

Before you begin, the following equipment is needed:

- Dual-output DC power supply, ±5V at 500mA
- Computer running Windows 98/2000, with a bidirectional or ECP parallel port
- Video signal sources (such as cameras)
- Video monitor(s)
- MAX4455 EV kit
- MAX4358 EV kit
- 25-pin I/O extension cable (included in EV kit)

Procedure

- 1) Carefully connect the boards by aligning the two right-angle headers of the MAX4455 EV kit with the corresponding headers of the MAX4358 EV kit. Gently press them together. The two boards should be flush against one another.
- 2) With the power supply off, connect the power supply to the MAX4358 EV kit terminal block TB1 (see Table 1).
- 3) With the power supply off, connect the power supply to the MAX4455 EV kit terminal block TB1 (see Table 1).
- 4) Install the EV system software on your computer by running the INSTALL.EXE program on the CD-ROM. The program files are copied and icons are created for them in the Windows Start menu. **Note: Windows 2000 requires an extra installation step; refer to file win2000.pdf.**
- 5) Ensure that the MAX4358 jumpers JU1–JU4 are open.
- 6) Turn on the power supply.
- 7) Connect the 25-pin I/O extension cable between the computer's parallel port and the MAX4358 EV kit. The MAX4358 EV kit includes a suitable 25-pin I/O extension cable. Snap on the included ferrite bead to reduce PC-generated noise from affecting the video boards.
- 8) Start the program by opening its icon in the Start menu.
- 9) Connect video signal sources to IN00...IN03 on the MAX4358 EV kit.
- 10) Connect video displays to OUT00...OUT03 on the MAX4358 EV kit.
- 11) Confirm that the software successfully connected video source IN00 to video monitor OUT00. The video signal should be visible on the monitor.

- 12) Confirm that the on-screen display is working by selecting the text tool (T) and then clicking in the middle of the large blue display control area. The Character Generator dialog box pops up. Click OK to copy the text to the on-screen display memory. Both the computer and the video monitor should show the key/fill text. **Note: The parallel port interface bandwidth severely limits the graphics transfer rate between the MAX4455 and the host PC.**

Table 1. MAX4455 EV System Power Connections

MAX4455 TB1 TERMINAL	REQUIRED POWER SUPPLY
+3.3V	Leave unconnected. Supplied by on-board linear regulator.
DGND	Digital ground return.
VKEY	OSDFILL power. Connect to +5V supply.
AGND	Analog ground return.
VCC	Main power. Connect to +5V supply.
VH1	Host power. Connect to +5V supply.
MAX4358 TB1 TERMINAL	REQUIRED POWER SUPPLY
VCC	Connect to +5V supply.
AGND	Analog ground return.
VEE	Connect to -5V supply.
DGND	Digital ground return.
VDD	Connect to +5V supply.

Detailed Description of Software

The MAX4455 EV kit software is a simple but effective paint program that draws on the on-screen display memory. There are nine drawing windows: one for each of the eight on-screen display channels, and a master window for simultaneously writing multiple channels. The large blue area represents the on-screen display memory. Each pixel in this area corresponds to one pixel in the on-screen display memory. Transparent areas are blue. The OSDKEY signal is automatically generated for any pixel that is not transparent. The software implements a few simple tools for drawing lines, boxes, and text. User-generated graphics can be loaded from standard Windows bitmap files, and the contents of the on-screen display can be saved to a standard Windows bitmap file. Tables 2–10 describe the buttons found on various toolbars.

MAX4455 Evaluation Kit/Evaluation System

Loading and Saving Files

The MAX4455 on-screen display uses 15-level grayscale patterns. When the MAX4455 EV kit software saves an image as a windows bitmap, each pixel of the on-screen display image is converted from 15-level grayscale into an equivalent RGB value:

```
osd_value &= 0x0F;
if (osd_value == 0) {
    unsigned __int8 red    = 0;
    unsigned __int8 green  = 0;
    unsigned __int8 blue   = 255;
} else {
    unsigned __int8 greyscale_nybble =
osd_value + 1;
    double luma = (greyscale_nybble *
256.0 / 16.0);
    if (luma > 255.0) { luma = 255.0; }
    if (luma < 0) { luma = 0; }
    unsigned __int8 red    = luma;
    unsigned __int8 green  = luma;
    unsigned __int8 blue   = luma;
}
color = ((blue * 0x10000) | (green * 0x100) |
(red));
```

When the MAX4455 EV kit software loads a Windows bitmap image, each pixel of the image is converted from RGB into an equivalent brightness (luma) value, in accordance with the following equation:

$$\text{Luma} = (0.299 \times \text{Red}) + (0.587 \times \text{Green}) + (0.114 \times \text{Blue})$$

The MAX4455 EV kit software uses pure saturated blue (RGB value of red = 0, green = 0, blue = 255) to designate transparent pixels.

Example code: converting RGB value into MAX4455 on-screen display control nybble:

```
const double ar = 0.299, ag =
0.587, ab = 0.114, offset = 0;
double luma = ar x red + ag x
green + ab x blue + offset;
unsigned __int8 greyscale_nybble =
((luma * 16.0) / 256) + 0.5;
if (greyscale_nybble > 15+1) {
greyscale_nybble = 15+1; }
if (greyscale_nybble < 1+1) {
greyscale_nybble = 1+1; }
osd_control_value = greyscale_nyb
ble - 1;
```

Creating Test Patterns

Simple brightness-gradient test patterns can be drawn interactively using the horizontal or vertical luma bar drawing tool. Click the desired tool button (■ or ■), and then drag the mouse across the opposite corners of the desired region. The white bar is always drawn near where the mouse is first clicked. All 15 grayscale levels are drawn, and one additional transparent bar is drawn just after the black bar.

Custom test patterns can be created using any paint program that can read and write Windows bitmap files. Always start with a pure saturated blue background (RGB value of red = 0, green = 0, blue = 255) for a transparent background.

Capture any program's output by pressing **ALT+PrintScreen**, then paste into the Windows Paint program and save as a bitmap. For example:

- 1) Run the MAX4455 EV kit software.
- 2) Click the View Channel 0 button (■).
- 3) Draw some luma bars (■ or ■) to use as a drawing palette (optional).
- 4) Locate your monitor's overscan boundary by pointing the camera at a black field, choose a contrasting drawing color (■), select the free-hand drawing tool (■), and drag the mouse around the edges of the on-screen display (optional).
- 5) Click the Save All button (■), saving the empty on-screen display memory.
- 6) Edit the saved bitmap using any suitable paint program.
- 7) Load your newly created test pattern using the Load All button (■). The test pattern is copied into the on-screen display memory.

Using Shared Memory

The MAX4455 can insert a horizontal band of on-screen display information from a different channel. This example draws vertical bars on channel 0 and horizontal bars on channel 2, then shares part of the channel 0 memory into the channel 2 display.

- 1) Click the View Channel 0 button (■).
- 2) Maximize the window.
- 3) Click the Vertical luma bars (■) drawing tool, and drag the mouse from the upper-left corner of the drawing area to the lower-right corner of the drawing area. (Once drawing begins, minimize the window to improve drawing speed.)
- 4) Click the View Channel 2 button (■).
- 5) Maximize the window.

MAX4455 Evaluation Kit/Evaluation System

- 6) Click the Horizontal luma bars (■) drawing tool, and drag the mouse from the upper-left corner of the drawing area to the lower-right corner of the drawing area.
- 7) Click the Shared Memory from Channel 0/1 button (■).
- 8) Click the Define Shared Memory button (■), and drag the mouse from the top of one of the bars to the bottom of the same bar.
- 9) View the video display connected to OUT02.

On the host PC, the software displays a colored rectangle indicating the band of shared memory. The monitor displays the horizontal bars test pattern, replacing the shared memory band with the vertical bars pattern from channel 0.

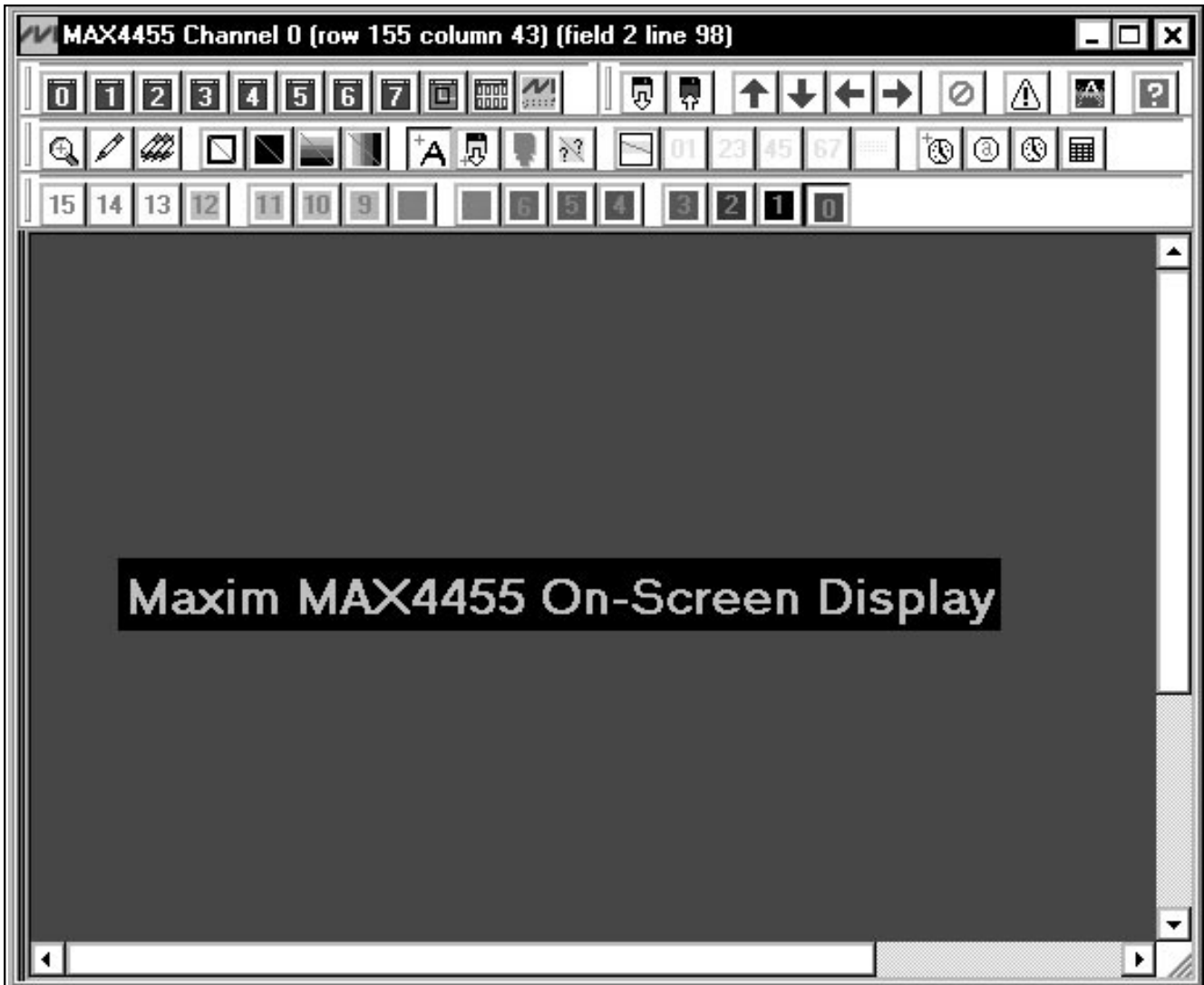

NOTE: EACH SINGLE-CHANNEL SCREEN PROVIDES DRAWING TOOLS, A LUMA VALUES PALETTE, AND A TIME STAMP.

Figure 1. MAX4455 Single-Channel Write

MAX4455 Evaluation Kit/Evaluation System

Using the Time Stamp

- 1) Click the View Channel 0 button (📺).
- 2) Enable the software time stamp by clicking the Time Stamp button (🕒).
- 3) Click the Query button (🔍), and move the mouse cursor to locate the top and bottom NTSC lines of the time stamp.
- 4) Click the View Channel 2 button (📺).
- 5) Click the Define Shared Memory button (📄).
- 6) Define the top and bottom of the shared memory band by dragging the mouse from the top NTSC line of the time stamp to the bottom NTSC line of the time stamp.
- 7) Click the Shared Memory from Channel 0/1 button (📄).

The parallel port interface bandwidth severely limits the graphics transfer rate between the MAX4455 and the host PC.

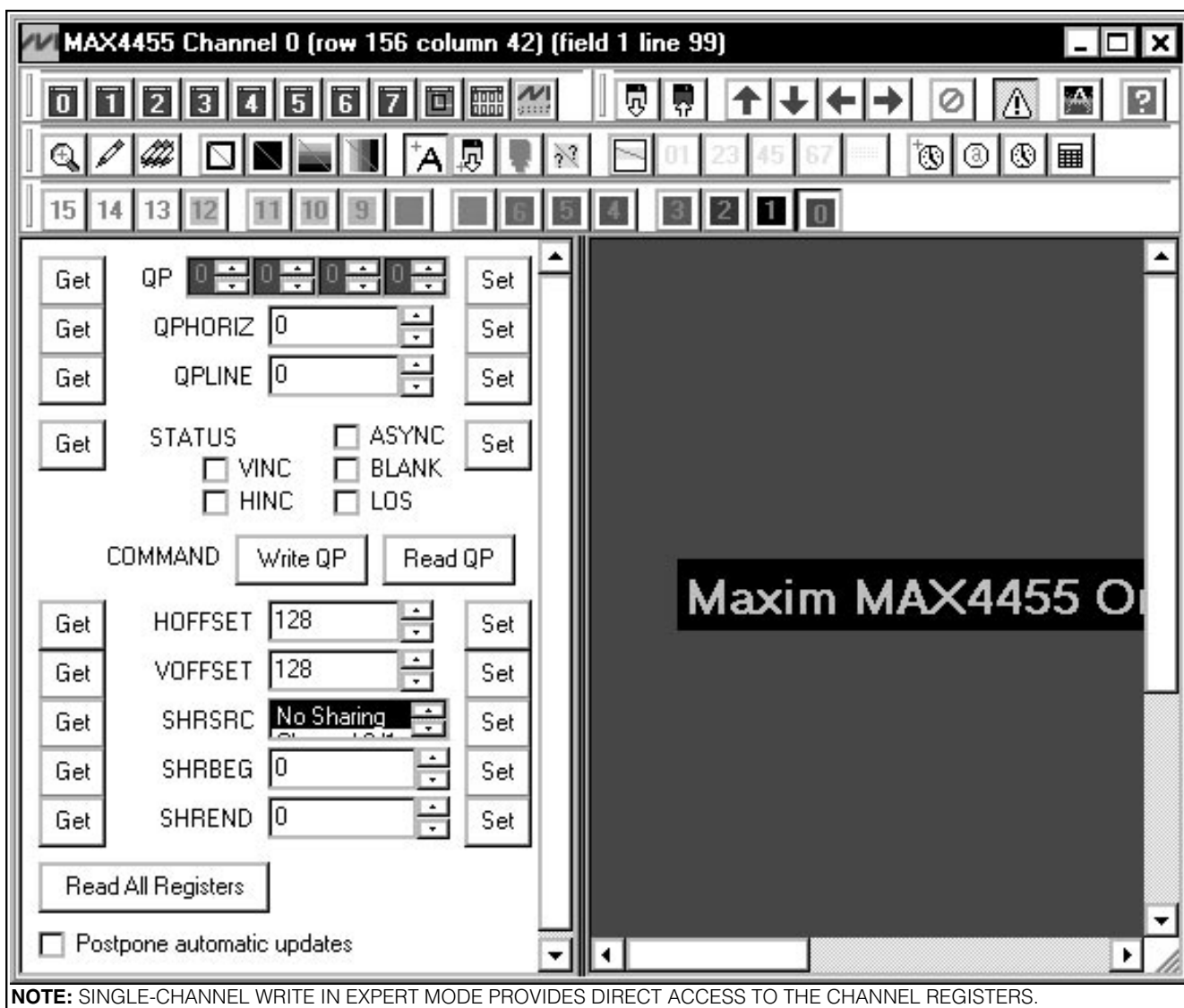

NOTE: SINGLE-CHANNEL WRITE IN EXPERT MODE PROVIDES DIRECT ACCESS TO THE CHANNEL REGISTERS.

Figure 2. MAX4455 Single-Channel Write—Expert Mode

MAX4455 Evaluation Kit/Evaluation System

Evaluate: MAX4455

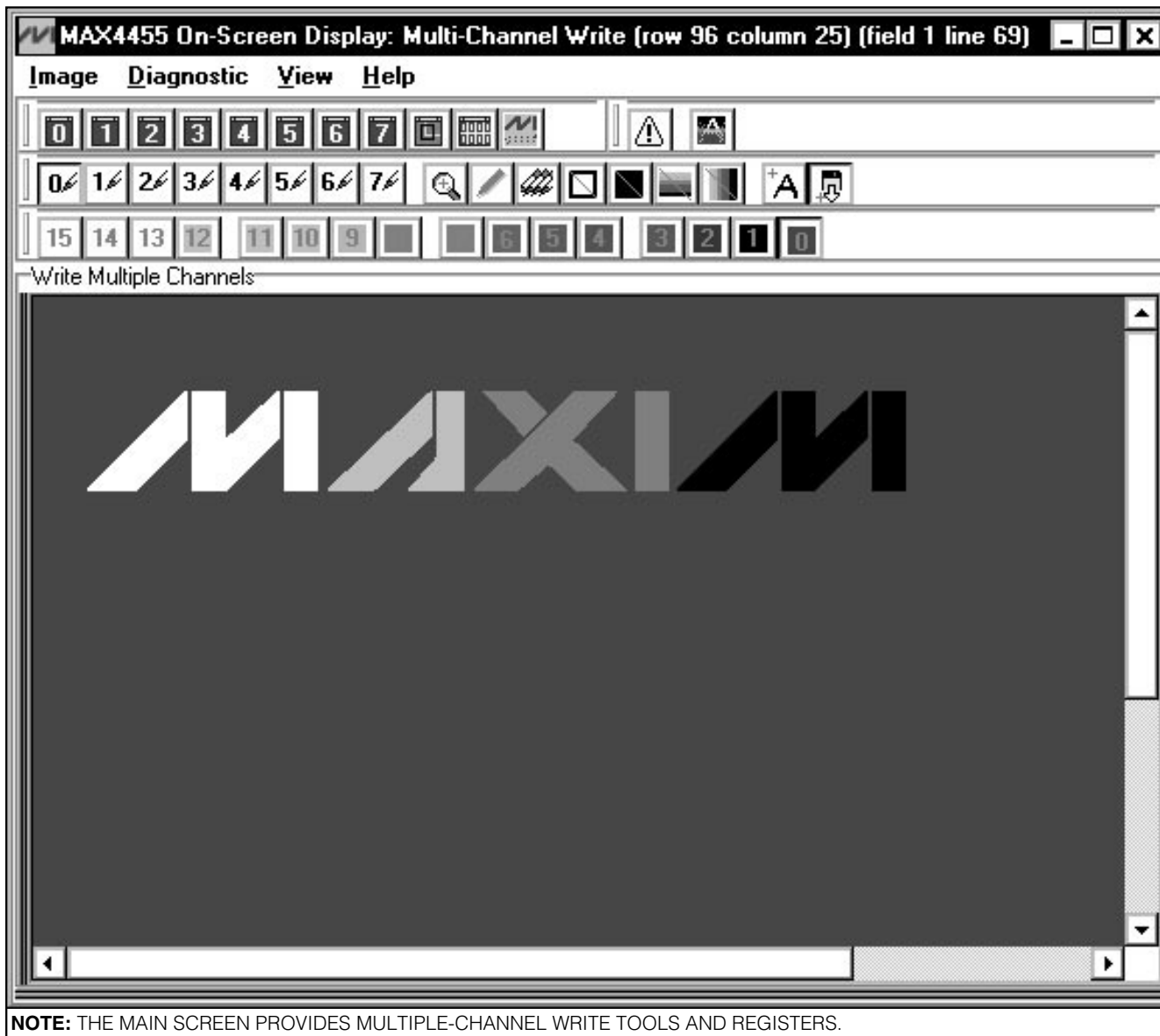

Figure 3. MAX4455 Multiple Channel Write

Low-Level Register Access

The MAX4455 registers can be accessed directly in expert mode, which is enabled by clicking the Expert Mode button (⚙️) (see Table 2).

Normally, the user interface automatically writes to affected registers as soon as a control is changed. If you check “postpone automatic updates,” you can

set up a write operation and control the exact moment when the register is updated. For example, you can type “150” into the VOFFSET edit field, and then click the VOFFSET SET button to perform the write.

MAX4455 Evaluation Kit/Evaluation System

Evaluate: MAX4455

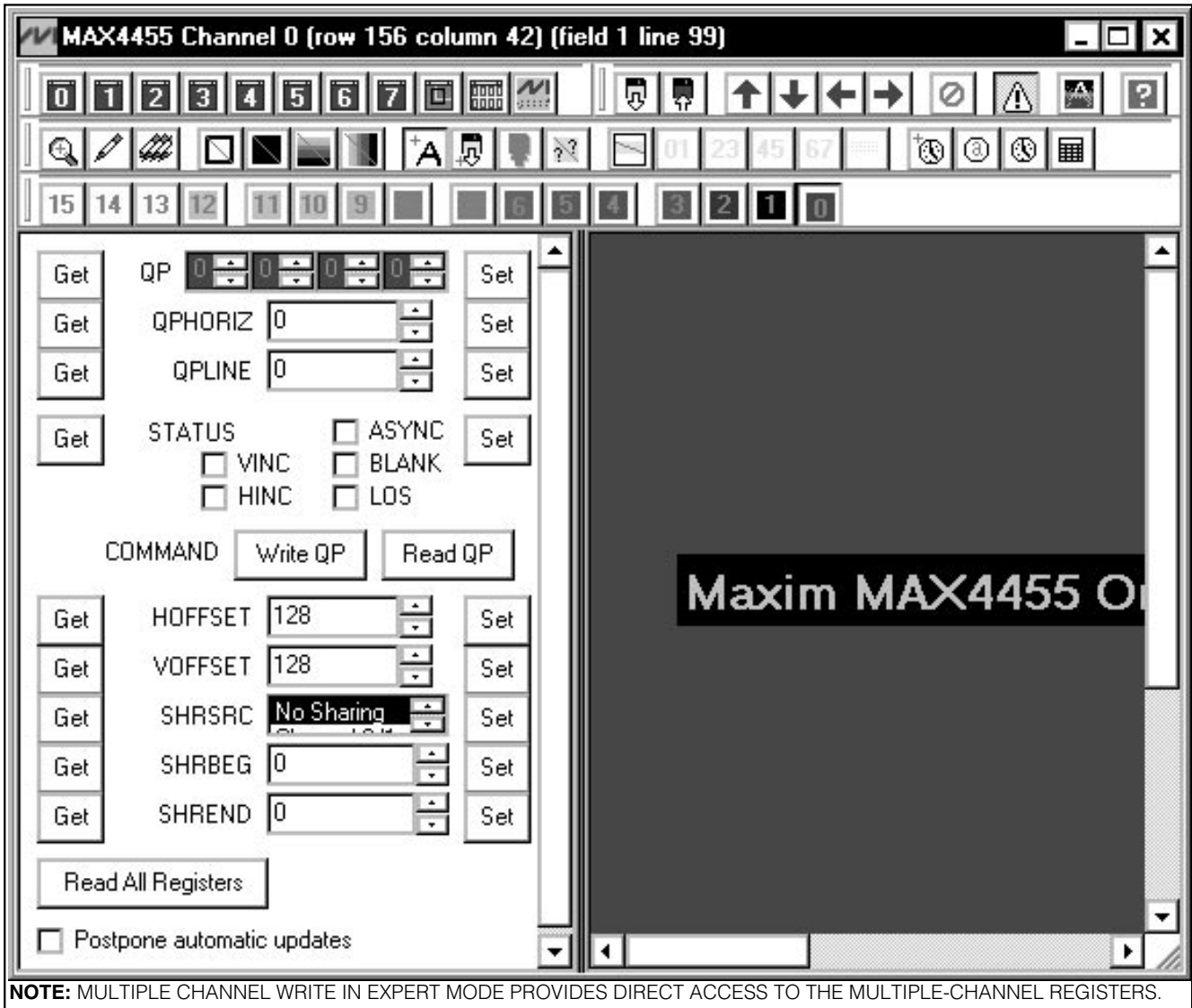

Figure 4. MAX4455 Multiple Channel Write—Expert Mode

MAX4455 Evaluation Kit/Evaluation System

Table 2. Command Buttons











BUTTON	FUNCTION
	Load bitmap file into on-screen display memory
	Save on-screen display memory to a bitmap file
	Decrease vertical offset, moving the on-screen display overlay up
	Increase vertical offset, moving the on-screen display overlay down
	Decrease horizontal offset, moving the on-screen display overlay to the left
	Increase horizontal offset, moving the on-screen display overlay to the right
	Inhibit the fill video insertion. Pass video signals with no on-screen display.
	Toggle Expert Mode on and off, enabling direct access to the MAX4455 registers
	Erase the on-screen display memory
	Display the help file

Table 4. Shared Memory Tool Buttons







BUTTON	FUNCTION
	Define the top and bottom of the shared memory band by dragging the mouse across the opposite corners of the desired region
	Select channel 0 or 1 as the source of the shared memory
	Select channel 2 or 3 as the source of the shared memory
	Select channel 4 or 5 as the source of the shared memory
	Select channel 6 or 7 as the source of the shared memory
	Disable shared memory

Table 3. Drawing Tool Buttons















BUTTON	FUNCTION
	Read the luma fill value stored at the selected line and column
	Freehand drawing single-pixel points by dragging the mouse
	Freehand drawing whole quad-pixel groups by dragging the mouse
	Draw an open rectangle by dragging the mouse across the opposite corners of the desired region
	Draw a rectangle filled with the selected luminance value by dragging the mouse across the opposite corners of the desired region
	Draw a rectangle filled with horizontal bars of varying luminance by dragging the mouse across the opposite corners of the desired region
	Draw a rectangle filled with vertical bars of varying luminance by dragging the mouse across the opposite corners of the desired region
	Place text where the mouse was clicked. This button runs the character generator dialog box to select font and insert text.
	Load a bitmap file into the on-screen display memory. The upper-left corner of the bitmap is placed where the mouse was clicked.
	Read a portion of the on-screen display memory into the host by dragging the mouse across the opposite corners of the desired region

Table 5. Time Stamp Buttons

BUTTON	FUNCTION
	Place the time stamp where the mouse was clicked
	Enable or disable the time stamp
	Enable or disable the date stamp
	Select the font to use for the time/date stamp

MAX4455 Evaluation Kit/Evaluation System

Table 6. Multiple Write Buttons









BUTTON	FUNCTION
	Enable or disable channel 0 when writing multiple channels
	Enable or disable channel 1 when writing multiple channels
	Enable or disable channel 2 when writing multiple channels
	Enable or disable channel 3 when writing multiple channels
	Enable or disable channel 4 when writing multiple channels
	Enable or disable channel 5 when writing multiple channels
	Enable or disable channel 6 when writing multiple channels
	Enable or disable channel 7 when writing multiple channels

Table 7. Window View Buttons











BUTTON	FUNCTION
	View multiple-write window (main window)
	View the channel 0 window
	View the channel 1 window
	View the channel 2 window
	View the channel 3 window
	View the channel 4 window
	View the channel 5 window
	View the channel 6 window
	View the channel 7 window
	View the MAX4358 crosspoint switch window
	View the parallel port diagnostics window

Table 8. Luma (Brightness) Buttons

















BUTTON	LUMA FILL VALUE	MAX4455 QUAD-PIXEL LUMA NYBBLE
	Transparent (no fill)	0
	Insert 7 IRE fill	1
	Insert 14 IRE fill	2
	Insert 21 IRE fill	3
	Insert 27 IRE fill	4
	Insert 34 IRE fill	5
	Insert 41 IRE fill	6
	Insert 47 IRE fill	7
	Insert 54 IRE fill	8

Table 8. Luma (Brightness) Buttons (continued)

BUTTON	LUMA FILL VALUE	MAX4455 QUAD-PIXEL LUMA NYBBLE
	Insert 60 IRE fill	9
	Insert 67 IRE fill	10
	Insert 74 IRE fill	11
	Insert 80 IRE fill	12
	Insert 87 IRE fill	13
	Insert 94 IRE fill	14
	Insert 100 IRE fill	15

MAX4455 Evaluation Kit/Evaluation System

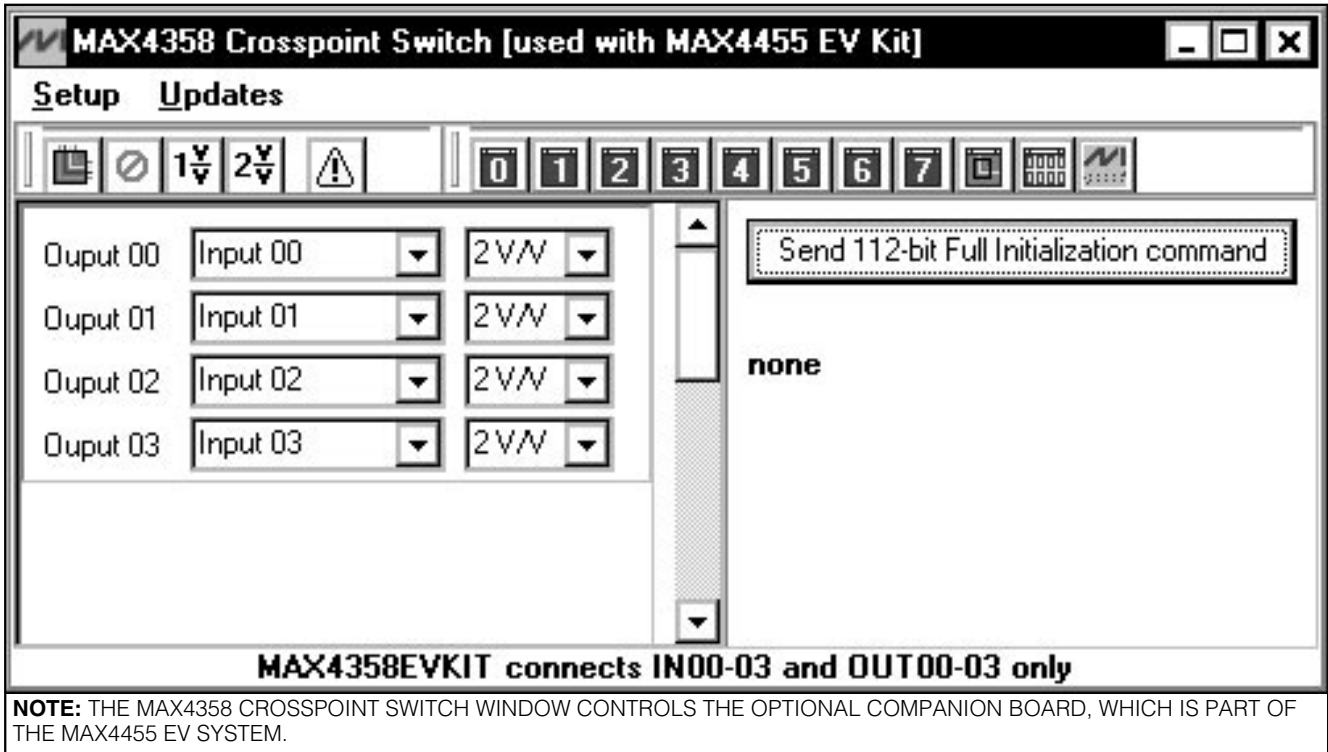



Figure 5. MAX4358 Crosspoint Switch

Table 9. MAX4358 Crosspoint Switch Command Buttons

BUTTON	FUNCTION
	Route MAX4358 inputs 0–15 to outputs 0–15
	Inhibit all video outputs
	Set all MAX4358 outputs to unity gain
	Set all MAX4358 outputs to a gain of 2V/V
	Toggle Expert Mode on and off, enabling access to all 32 inputs and all 16 outputs

PAL/SECAM Compatability

When used with PAL or SECAM video systems, use the vertical offset () to position the active portion of the on-screen display so that it is visible.

Writing a Single Channel

The single-channel screen includes the drawing tools, plus shared memory, vertical and horizontal offset, reading on-screen display memory, and display inhibit. Due to the severely limited bandwidth of the parallel port, the MAX4455 EV kit software time-stamp function is not offered for the multiple-write screen (see the *Using the Time Stamp* section).

MAX4455 Evaluation Kit/Evaluation System

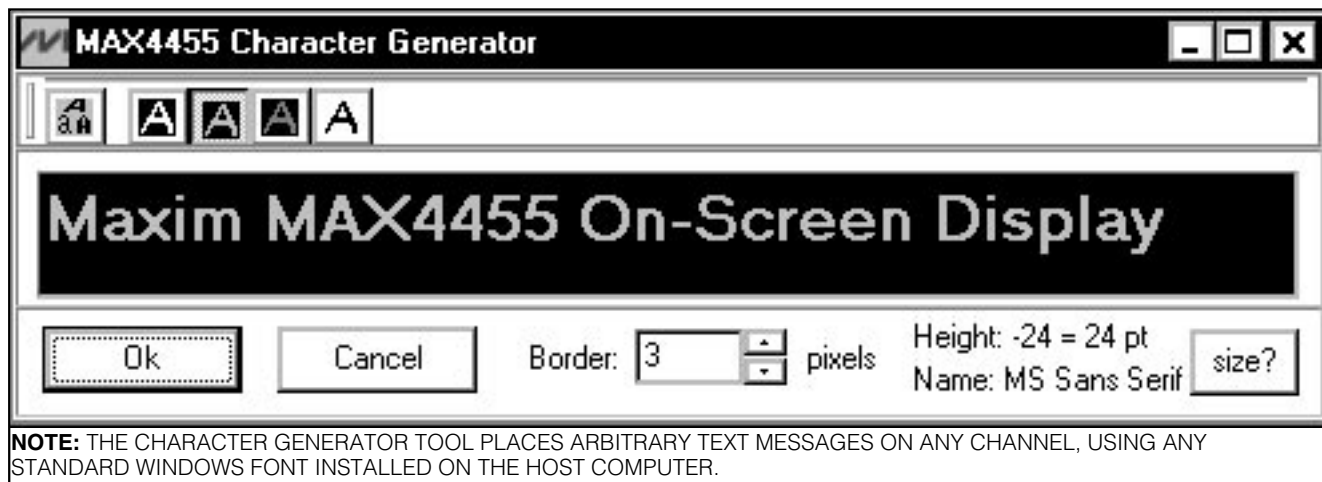

Figure 6. MAX4455 Character Generator

Table 10. Character Generator Command Buttons

BUTTON	FUNCTION
	Choose which windows font to use when drawing text
	Write white text (100 IRE) on a black background
	Write light gray text (74 IRE) on a black background
	Write dark gray text (47 IRE) on a black background
	Write black text (0 IRE) on a white (100 IRE) background

Writing Multiple Channels

The main screen's drawing tools can draw on all eight channels of the on-screen display. Table 6 shows the buttons that enable or disable each channel. When the program starts, channel 0 is automatically enabled. The main screen has a diagnostic menu, with global settings related to low-level register access. These settings do not need to be changed.

MAX4358 Crosspoint Switch

The MAX4455 EV kit is designed for use with the MAX4358 crosspoint switch. To control the MAX4358 EV kit (included in the MAX4455EVSYS), choose the MAX4358 crosspoint from the view menu (see Figure 5).

Each of the outputs has a drop-down combo box to select an input signal. Each output can also be configured for unity gain or a gain of 2V/V. The setup menu lets you quickly disable all outputs, or quickly connect each output to a preset input.

Due to space limitations, the MAX4358 EV kit provides BNC connectors for only four of its 16 outputs and only four of its 32 inputs. However, the entire chip is functional, and the software allows control of all channels. When expert mode is selected, the GUI provides controls for all inputs and outputs, as well as exposing the IC address pin controls.

MAX4455 Evaluation Kit/Evaluation System

Character Generator

The MAX4455 EV kit software can generate text labels using any standard Windows font installed on the host computer system. Typical Windows systems usually include Arial, Courier New, and Times New Roman fonts.

The font selector button runs the standard Windows font selector dialog box, which lets you choose from any of the fonts installed on your system.

The text color buttons set the text foreground color to luma values of 100 IRE, 74 IRE, 47 IRE, or 0 IRE.

Detailed Description of Hardware

The MAX4455 EV kit consists of a MAX4455 arbitrary graphics on-screen display video generator, a synchronous dynamic RAM, a 3.3V crystal oscillator module, and a 3.3V linear regulator. Cost-sensitive applications can replace the crystal oscillator module with a 40.5MHz fundamental mode crystal. Resistor R1 sets the white video fill. (Refer to the MAX4455 data sheet for white level calculation.)

The crosspoint outputs are sampled through the right-angle connector J5, or can optionally be fed through the BNC jacks. Resistor/capacitor networks such as C32-C33-R10 sample the video signals.

Because the MAX4455 EV system uses a bidirectional parallel printer cable as opposed to a local microprocessor bus, Schmitt triggers are used to sharpen the rise times of the read and write strobes. These Schmitt trigger buffers are located on the MAX4358 EV kit companion board.

Design Considerations

For best picture quality, the design of a custom MAX4455 on-screen display system requires careful attention to the ground return paths. The MAX4455 video outputs switch a significant amount of current into the analog ground return.

The EV kit is designed as a two-board set to accommodate customers using different video crosspoints. However, for best results, the MAX4455 should be located close to the crosspoint switch.

The MAX4455 is designed to interface directly to a microprocessor. The EV kit uses the parallel port for ease of evaluation, which is not recommended for production designs. Throughput is severely limited, and the long cable requires Schmitt trigger buffers to clean up the read/write strobes.

Troubleshooting

Problem: display seems to flicker

Interlaced raster scan can appear to flicker for test patterns that have sharp, single-pixel horizontal lines. Flicker is worst on small, bright, high-contrast features. Apply a digital anti-aliasing function across the test pattern before writing it to the MAX4455. Do not write single-pixel lines; instead, write both field 1 and field 2 of each NTSC line pair.

Problem: software can't read MAX4455 EV kit

Although the MAX4455 EV kit works directly with most modern computers, some systems require that the parallel port must be enabled for bidirectional mode in the BIOS setup screen. You must reboot your computer, enter BIOS setup before Windows starts, find the integrated peripherals screen, and ensure that the LPT port is configured as an ECP port. Standard and EPP parallel port settings are not compatible with the MAX4455 EV kit.

Problem: switching channels causes the display to roll

If the MAX4455 inserts video fill during the vertical blanking interval, it can miss the vertical sync information. The solution is to set the BLANK bit true when switching the crosspoint. Once video sync is established, set the BLANK bit false to re-enable the video fill. (Refer to the MAX4455 data sheet for more information.)

MAX4455 Evaluation Kit/Evaluation System

Evaluate: MAX4455

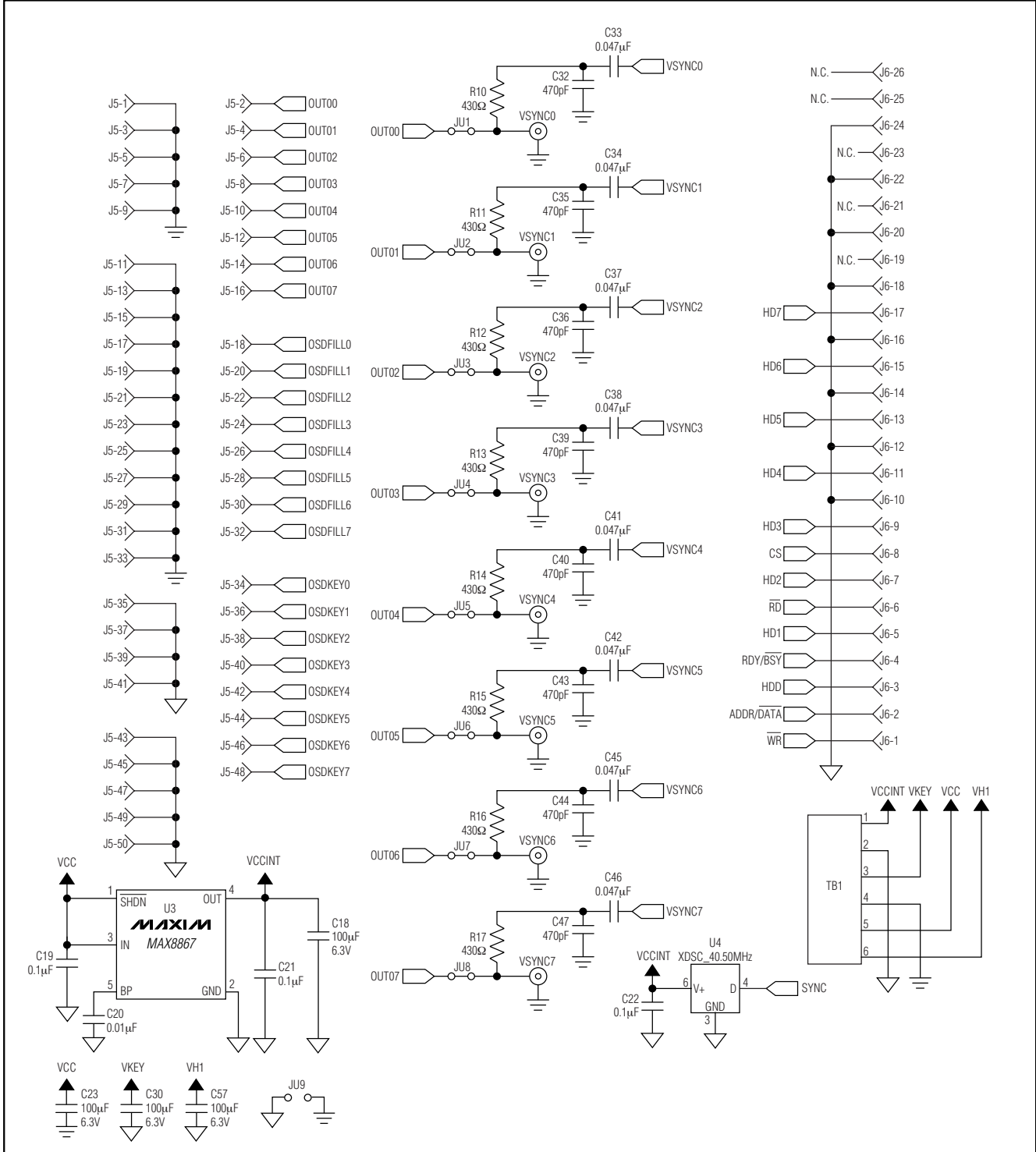

Figure 7. MAX4455 EV Kit Schematic (Sheet 2 of 2)

MAX4455 Evaluation Kit/Evaluation System

Evaluate: MAX4455

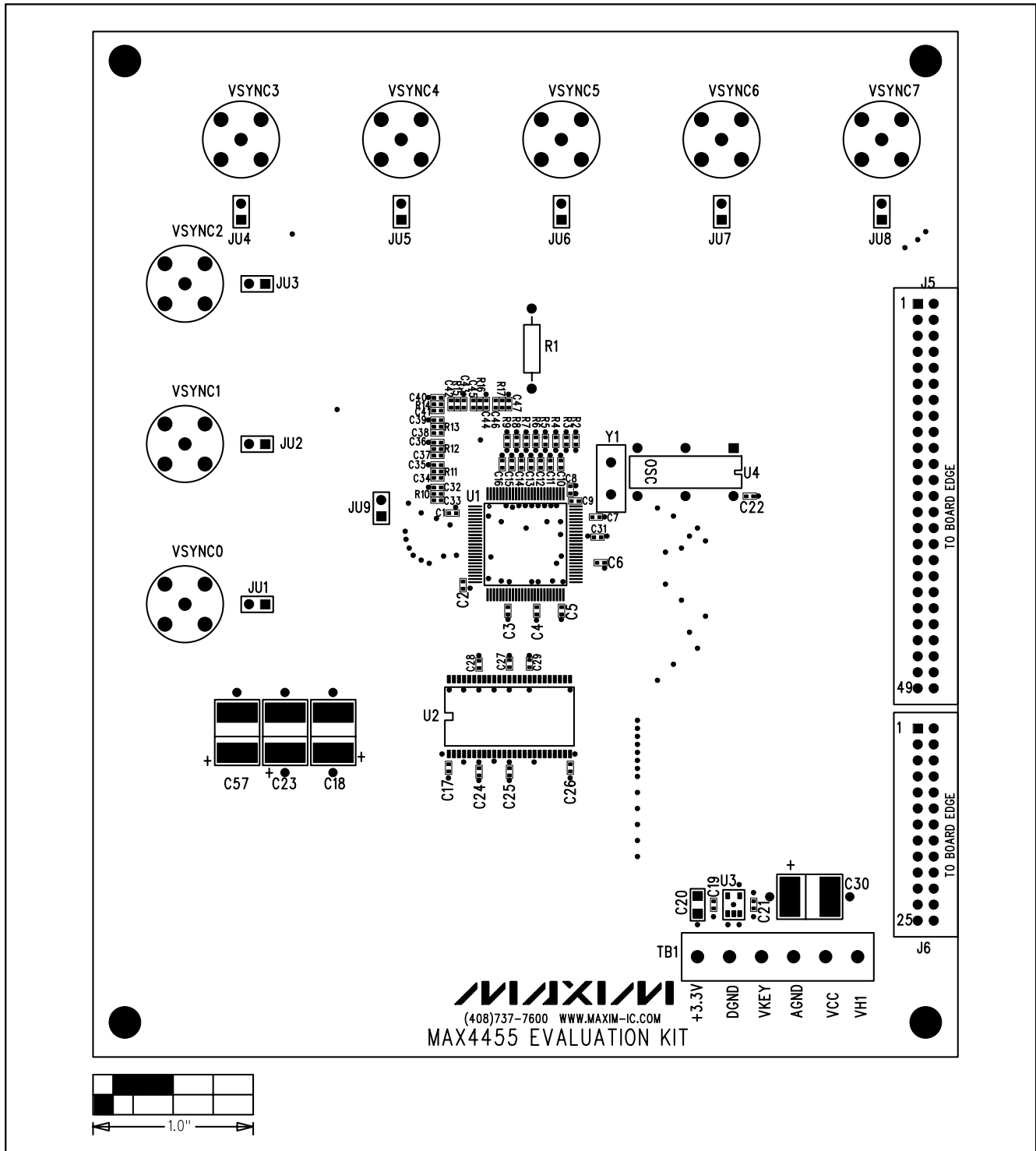

Figure 8. MAX4455 EV Kit Component Placement Guide—Component Side

MAX4455 Evaluation Kit/Evaluation System

Evaluate: MAX4455

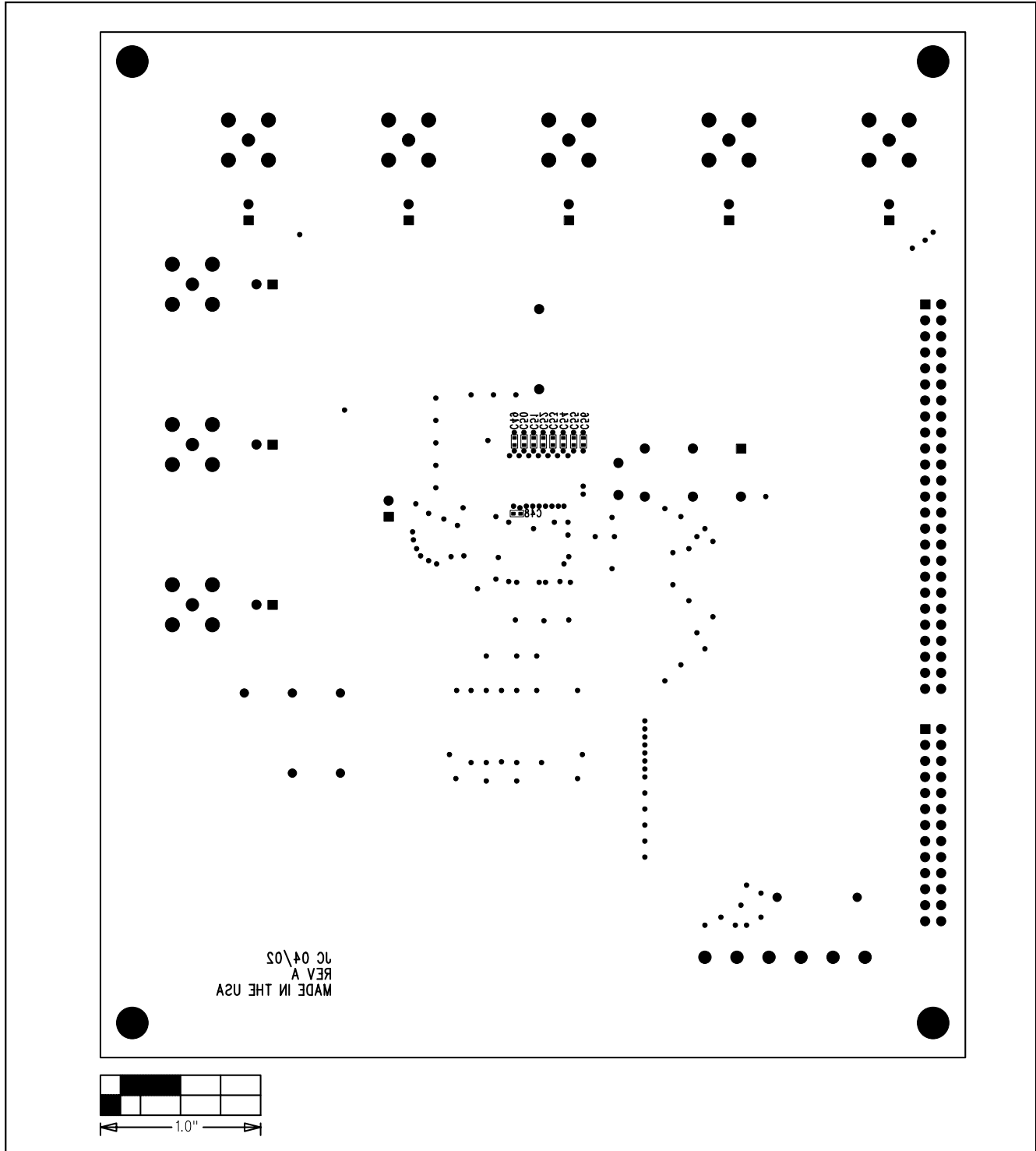

Figure 9. MAX4455 EV Kit Component Placement Guide—Solder Side

MAX4455 Evaluation Kit/Evaluation System

Evaluate: MAX4455

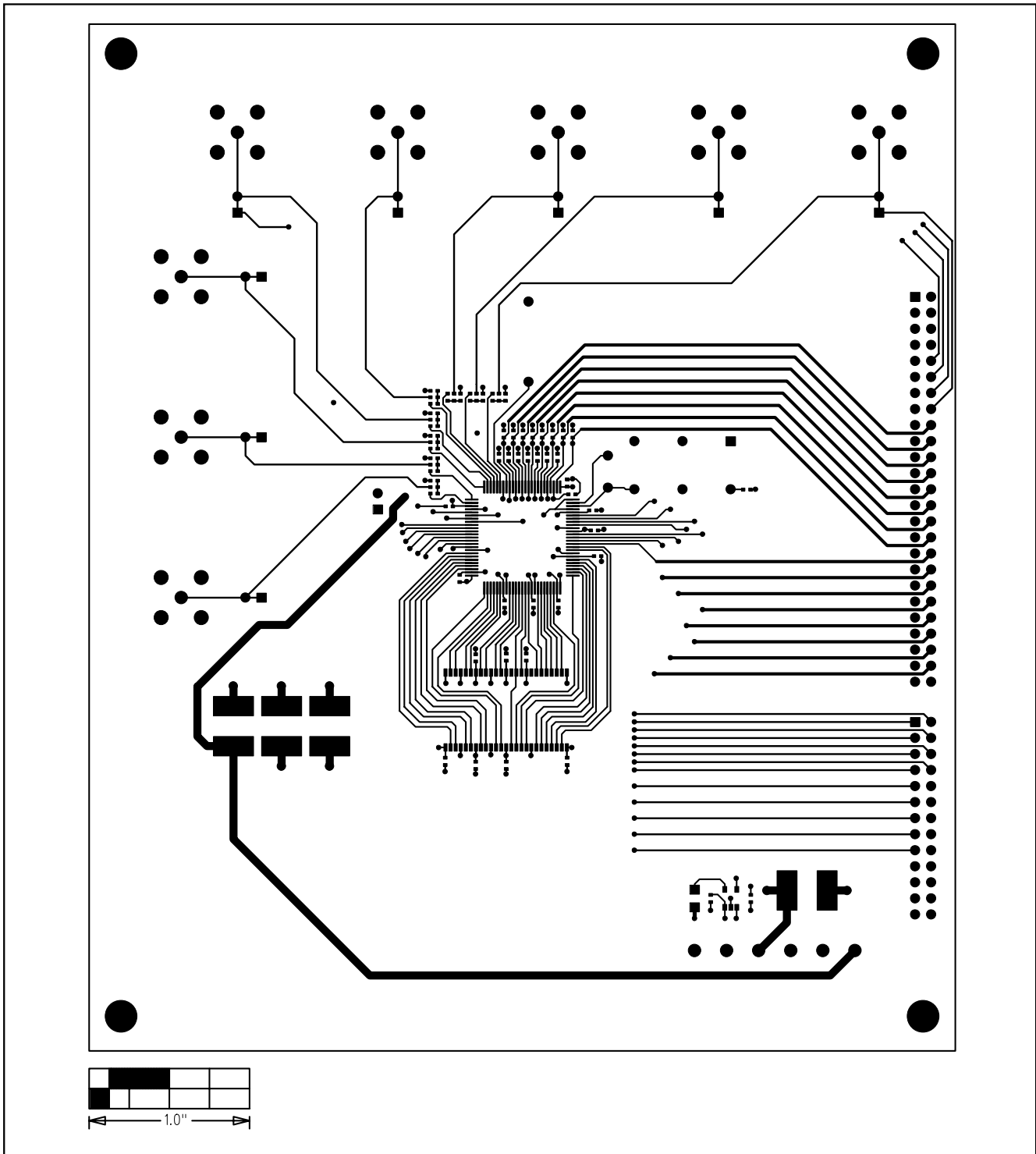

Figure 10. MAX4455 EV Kit PC Board Layout—Component Side

MAX4455 Evaluation Kit/Evaluation System

Evaluate: MAX4455

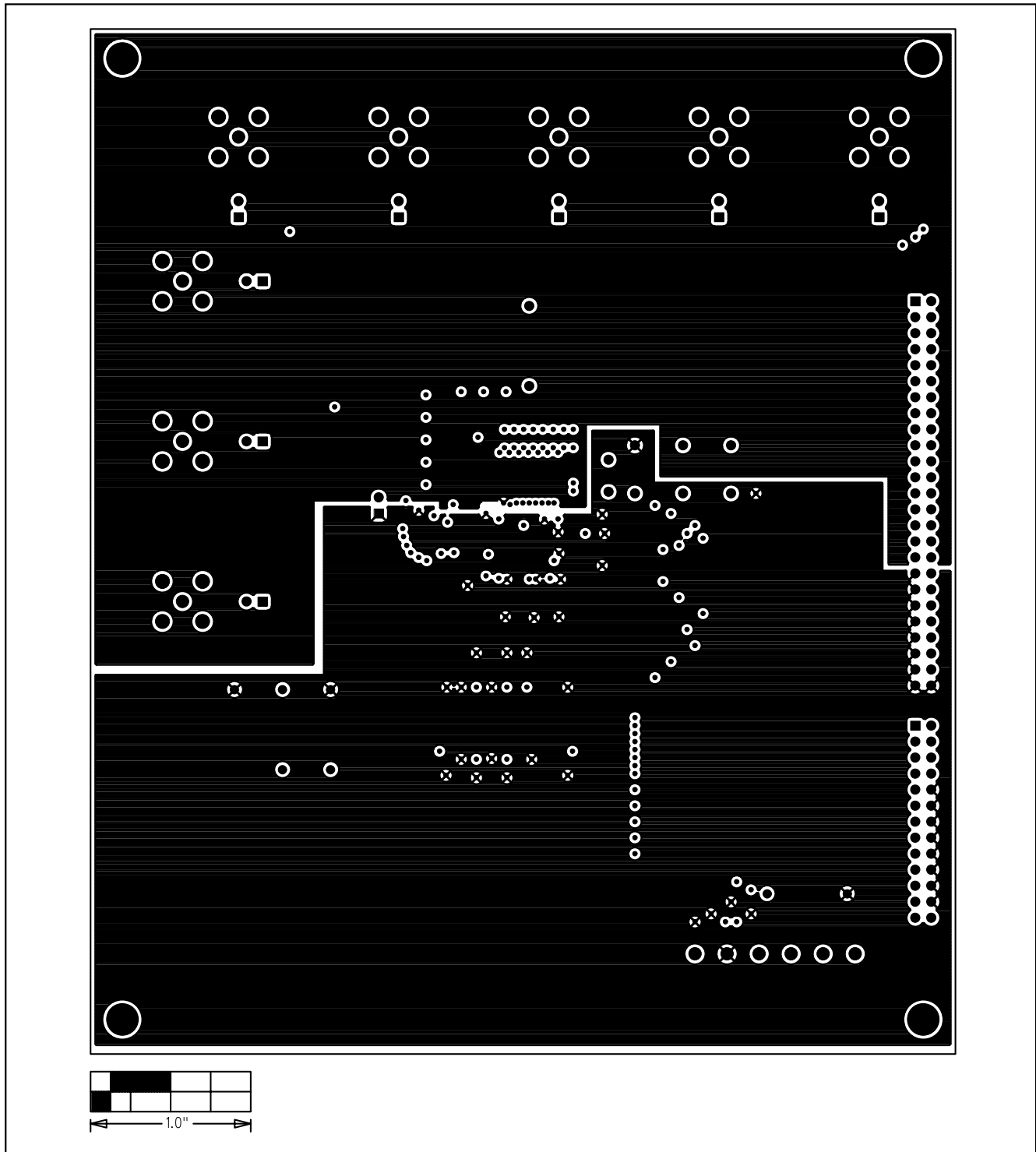

Figure 11. MAX4455 EV Kit PC Board Layout—Internal Layer 2

MAX4455 Evaluation Kit/Evaluation System

Evaluate: MAX4455

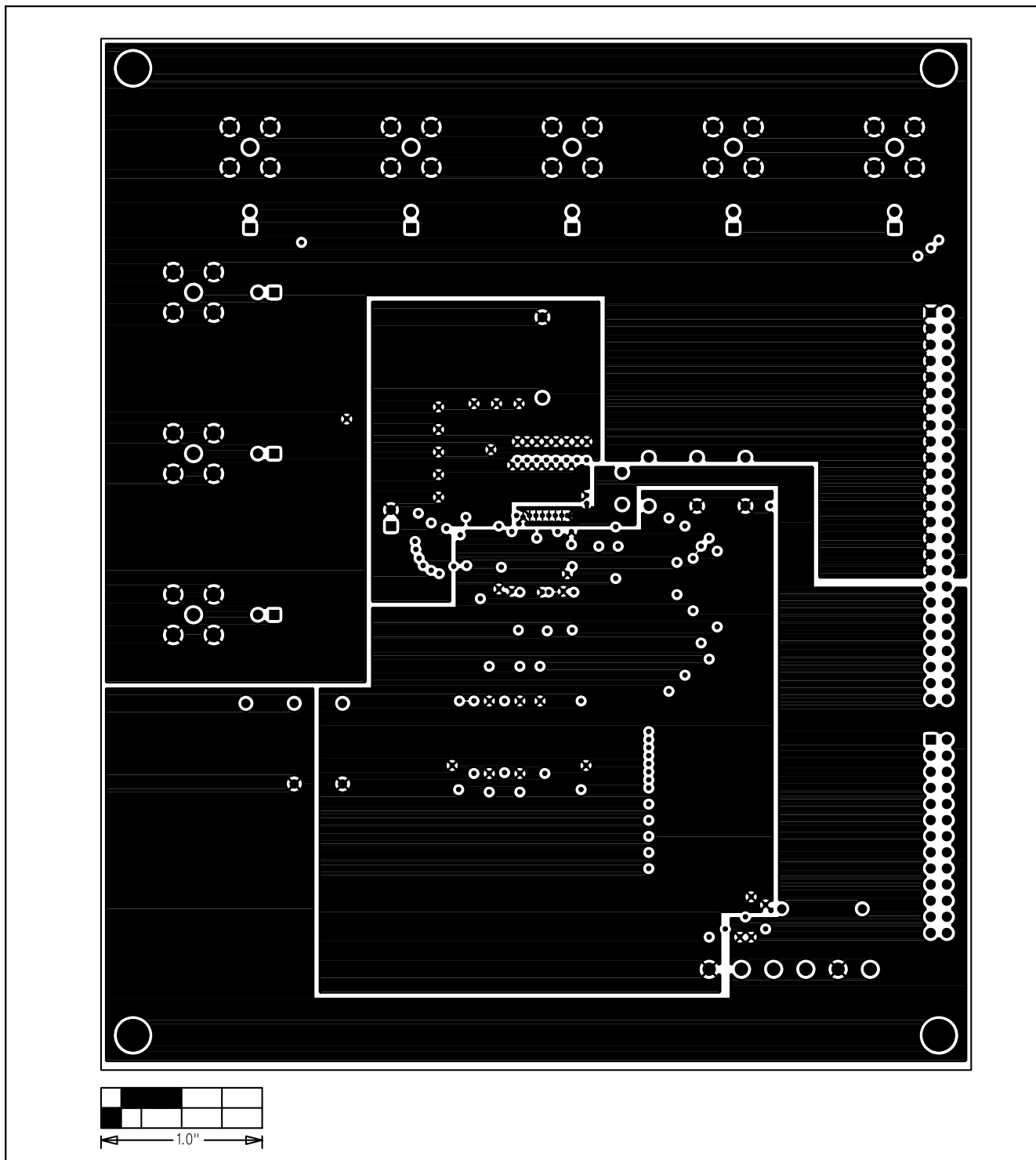

Figure 12. MAX4455 EV Kit PC Board Layout—Internal Layer 3

MAX4455 Evaluation Kit/Evaluation System

Evaluate: MAX4455

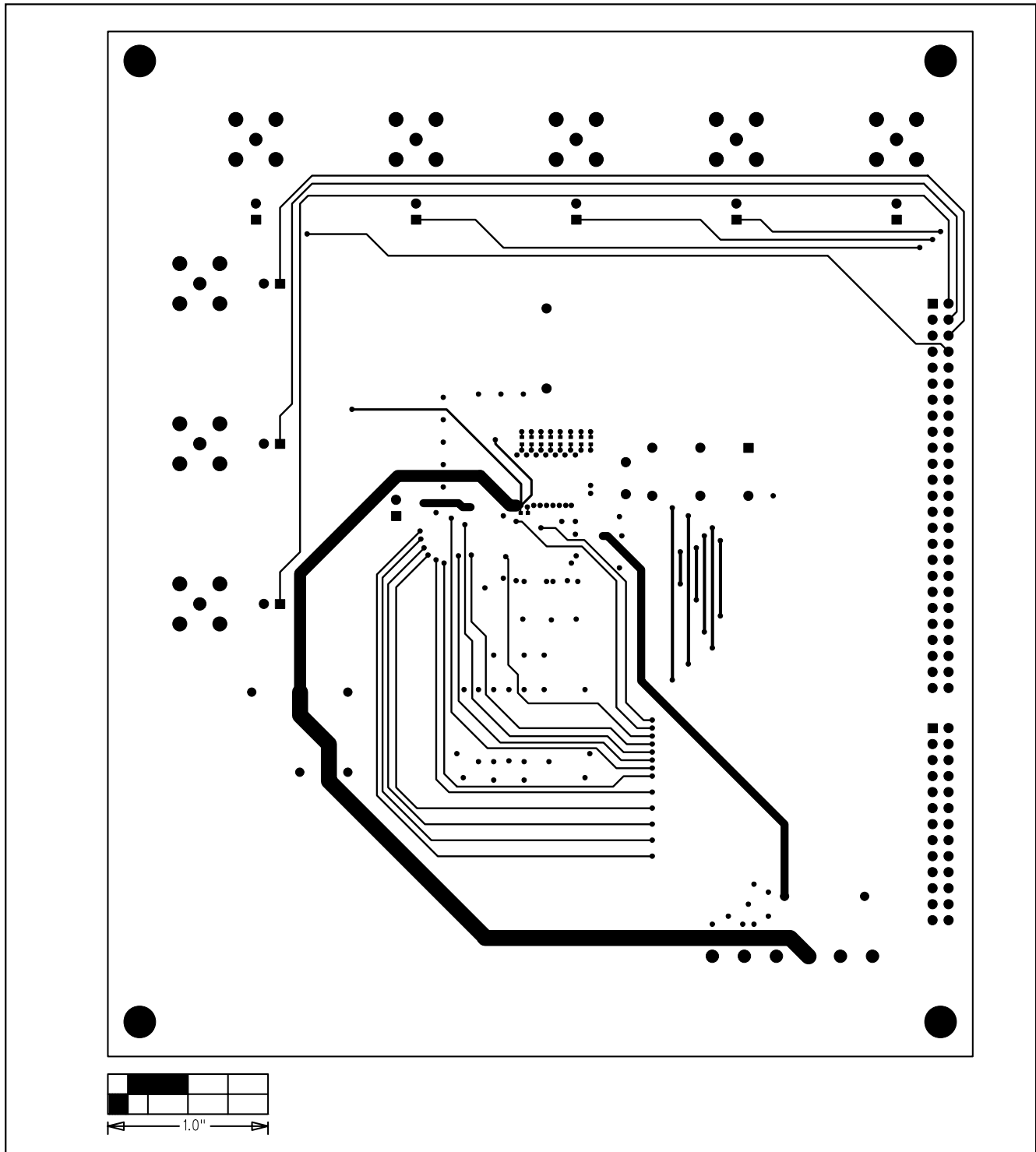

Figure 13. MAX4455 EV Kit PC Board Layout—Solder Side

Maxim cannot assume responsibility for use of any circuitry other than circuitry entirely embodied in a Maxim product. No circuit patent licenses are implied. Maxim reserves the right to change the circuitry and specifications without notice at any time.

20 **Maxim Integrated Products, 120 San Gabriel Drive, Sunnyvale, CA 94086 408-737-7600**