



LC72700E, LC72700G

Mobile FM Multiplex Broadcast Receiver LSI



Overview

The LC72700E and LC72700G are data decoder LSIs for receiving DARC™ mobile FM multiplex broadcasts. A multi-function, compact, adjustment-free system can be implemented in two chips by combining this LSI with the LV3400M band-pass filter IC, which extracts the multiplex components from a composite FM signal.

Functions and Features

- Delay detection scheme using a 1T delay
- Built-in error correction function using a 2T delay
- Digital PLL clock regeneration

- Block and frame synchronization detection with a settable synchronization protection count
- Settable block identifier code (BIC) detection precision
- Error correction using (272,190) codes
- Built-in frame memory for product codes
- Support for both serial and parallel data I/O
- Package
LC72700E: QFP48E
LC72700G: QFP48G

- CCB is a trademark of SANYO ELECTRIC CO., LTD.
- CCB is SANYO's original bus format and all the bus addresses are controlled by SANYO.

Package Dimensions

unit: mm

3156-QFP48E

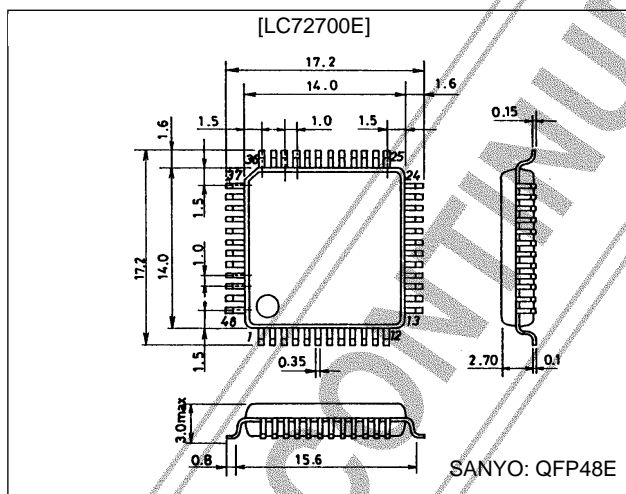

unit: mm

3229-QFP48G

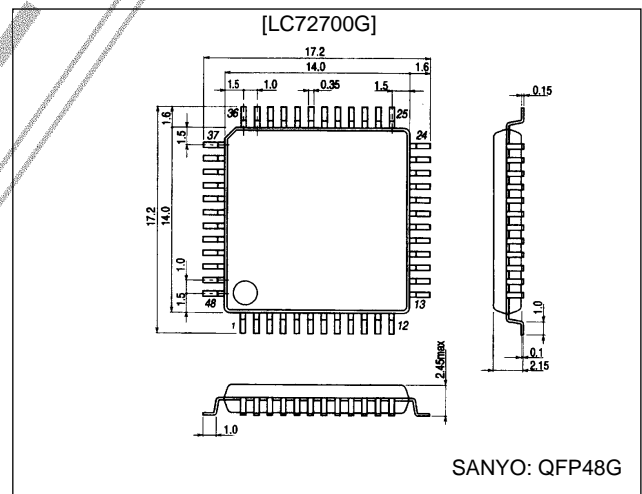

Specifications

Absolute Maximum Ratings at Ta = 25°C

Parameter	Symbol	Conditions	Ratings	Unit
Maximum supply voltage	V _{DD} max	V _{DD}	-0.3 to +7.0	V
Input voltage	V _{IN1}	CL, CE, and DI pins	-0.3 to +7.0	V
	V _{IN2}	Input pins other than V _{IN1}	-0.3 to V _{DD} + 0.3	V
Output voltage	V _{OUT1}	DO pin	-0.3 to +7.0	V
	V _{OUT2}	Output pins other than V _{OUT1}	-0.3 to V _{DD} + 0.3	V
Output current	I _{OUT}	BCLOCK, FCLOCK, and DO pins	0 to 4.0	mA
Allowable power dissipation	Pd max	Ta ≤ 85°C	400	mW
Operating temperature	Topr		-40 to +85	°C
Storage temperature	Tstg		-55 to +125	°C

SANYO Electric Co.,Ltd. Semiconductor Business Headquarters

TOKYO OFFICE Tokyo Bldg., 1-10, 1 Chome, Ueno, Taito-ku, TOKYO, 110 JAPAN

LC72700E, LC72700G

Allowable Operating Ranges at $T_a = -40$ to $+85^\circ\text{C}$, $V_{SS} = 0\text{ V}$

Parameter	Symbol	Conditions	min	typ	max	Unit
Supply voltage	V_{DD}	V_{DD}	4.5	5.0	5.5	V
Input high level voltage	V_{IH1}	MSK, DAT0 to 7, RE, PST, S/P, PORT0 to 2, RST, TEST1, TEST2	$0.7 V_{DD}$		V_{DD}	V
	V_{IH2}	CL, CE, DI	$0.7 V_{DD}$		5.5	V
Input low level voltage	V_{IL1}	MSK, DAT0 to 7, RE, PST, S/P, PORT0 to 2, RST, TEST1, TEST2	V_{SS}		$0.3 V_{DD}$	V
	V_{IL2}	CL, CE, DI	V_{SS}		$0.3 V_{DD}$	V
Oscillator frequency	F_{OSC}	*1		7.2		MHz
Input sensitivity	V_{XI}	XIN, sine wave, capacitive coupling	400		1500	mVrms
Serial I/O ²						
Clock low level time	t_{CL}	CL	0.7			μs
Clock high level time	t_{CH}	CL	0.7			μs
Data setup time	t_{SU}	CL, DI	0.7			μs
Data hold time	t_{HD}	CL, DI	0.7			μs
CE wait time	t_{EL}	CL, CE	0.7			μs
CE setup time	t_{ES}	CL, CE	0.7			μs
CE hold time	t_{EH}	CL, CE	0.7			μs
Data latch switching time	t_{LC}				0.7	μs
Data output time	t_{DDO}	DO, CE	277		555	ns
Parallel I/O ³						
RE wait time	t_{RE}	RE	1			μs
RDY wait time	t_{DRD}	RE, RDY	0.5		0.8	μs
RDY output time	t_{RDY}	RDY		2.2		μs
PST input time	t_{PS}	PST	0.3			μs
PST hold time	t_{PH}	PST, DAT0 to 7, PORT0 to 2	10			ns
I/O direction switching time	t_{DIR}	PST, DAT0 to 7	0.5		0.8	μs

- Note: 1. This LSI operates at a frequency of 7.2 MHz \pm 250 ppm.
 2. See the parallel data timing.
 3. See the parallel data timing.

Electrical Characteristics in the Allowable Operating Ranges

Parameter	Symbol	Conditions	min	typ	max	Unit
High level output voltage	V_{OH1}	$I_O = 1\text{ mA}$, FILCK, CLK, DATA	$V_{DD} - 1.0$			V
	V_{OH2}	$I_O = 2\text{ mA}$, DAT0 to 7, BCLOCK, FCLOCK, BL-CK, FC-CK, INT-R, RDY, RDY0	$V_{DD} - 0.4$			V
Low level output voltage	V_{OL1}	$I_O = 1\text{ mA}$, for the V_{OH1} applicable pins			1.0	V
	V_{OL2}	$I_O = 2\text{ mA}$, for the V_{OH2} applicable pins			0.4	V
	V_{OL3}	$I_O = 2\text{ mA}$, DO			0.4	V
High level input current	I_{IH1}	$V_{IN} = 5.5\text{ V}$, CE, CL, DI			1	μA
	I_{IH2}	$V_{IN} = V_{DD}$, input pins except I_{IH1}			1	μA
Low level input current	I_{IL1}	$V_{IN} = V_{SS}$, CE, CL, DI			-1	μA
	I_{IL2}	$V_{IN} = V_{SS}$, inputs with pull-up resistors, RE, PST, PORT0 to 2, S/P	-100			μA
	I_{IL3}	$V_{IN} = V_{SS}$, MSK, RST			-1	μA
Output off leakage current	I_{OFF}	$V_O = V_{DD}$, DO			5	μA
Hysteresis voltage	V_{HIS}	MSK, CL, CE, DI, RST		$0.1 V_{DD}$		V
Built-in feedback resistance	R_f	XIN, XOUT		1.0		$\text{M}\Omega$
Pull-up resistance	R_{pu}	RE, PST, PORT0 to 2, S/P		50		$\text{k}\Omega$
Current drain	I_{DD}			16	25	mA

LC72700E, LC72700G

Block Diagram

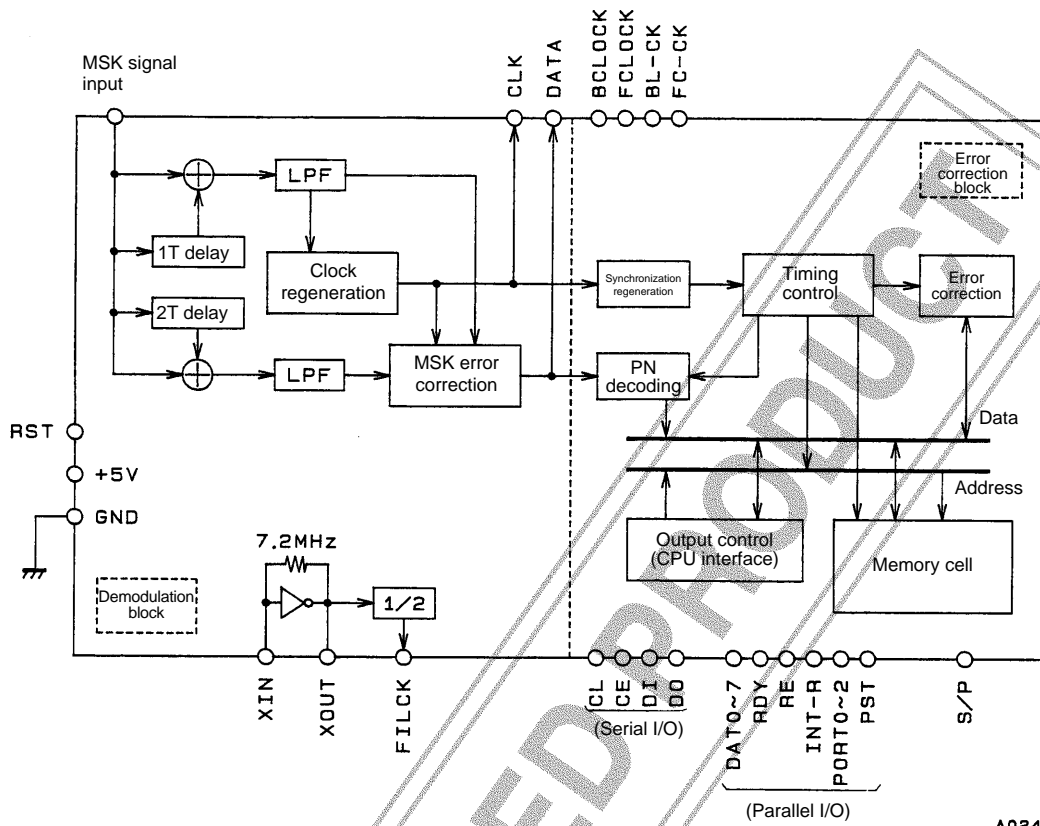

A02410

Pin Assignment

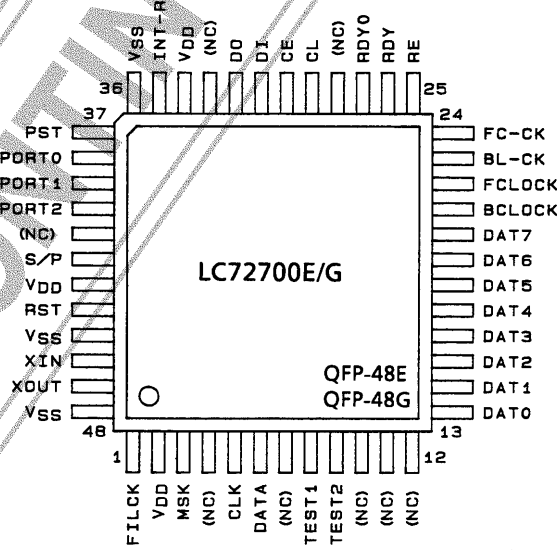





(Top view)

A02411

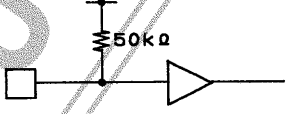
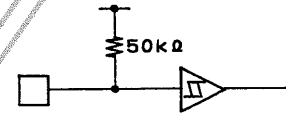
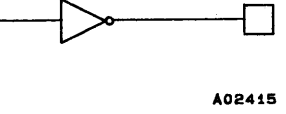
LC72700E, LC72700G

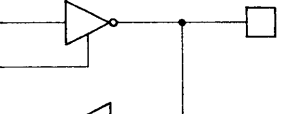
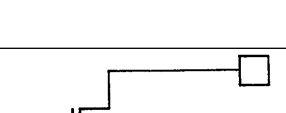
Pin Descriptions

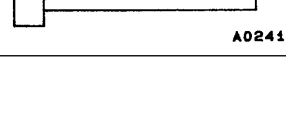
Pin No.	Symbol	Function	I/O	I/O Circuit
3	MSK	76 kHz MSK signal input	Input	
29	CL	CCB serial interface Clock input		
30	CE	Data control input		
31	DI	Data input		
44	RST	System reset input pin (negative logic)		
8	TEST1	Test pin 1 (normally connected to ground)	Input	
9	TEST2	Test pin 2 (normally connected to ground)		
37	PST	Parallel IF mode data settings		
38	PORT0	Port address 0	Input	
39	PORT1	Port address 1		
40	PORT2	Port address 2		
42	S/P	Serial/parallel IF switch (Serial mode when high)	Input	
25	RE	Parallel IF mode data output control signal input	Input	
1	FILCK	Reference clock output for the LV3400M	Output	
5	CLK	Clock regeneration monitor output		
6	DATA	Demodulated data monitor output		
21	BCLOCK	Outputs a high level during block synchronization		
22	FCLOCK	Outputs a high level during frame synchronization		
23	BL-CK	Block start signal output	Output	
24	FC-CK	Frame start signal output		
26	RDY	Parallel IF data output enable signal		
27	RDY0	Parallel IF data output enable signal	Output	
35	INT-R	Output data external CPU interrupt signal		
13	DAT0	Parallel IF data output pin 0		
14	DAT1	Parallel IF data output pin 1	I/O	
15	DAT2	Parallel IF data output pin 2		
16	DAT3	Parallel IF data output pin 3		
17	DAT4	Parallel IF data output pin 4		
18	DAT5	Parallel IF data output pin 5		
19	DAT6	Parallel IF data output pin 6		
20	DAT7	Parallel IF data output pin 7		
32	DO	CCB serial interface data output		
46	XIN	System clock oscillator crystal connection	Input	
47	XOUT		Output	
2, 34, 43 36, 45, 48	V _{DD} V _{SS}	Power supply (+4.5 to +5.5 V) Ground pin	— —	
4, 7, 10 11, 12, 28 33, 41	NC	Not connected	—	

Serial Data I/O Scheme

1. CCB Format

The figure shows the Sanyo audio LSI serial bus format. Data is input and output over a CCB (computer control bus). This LSI uses an 8-bit address CCB format.

I/O mode	Address								Function
	B0	B1	B2	B3	A0	A1	A2	A3	
Input	0	1	0	1	1	1	1	1	16-bit control data input
Output	1	1	0	1	1	1	1	1	Data output

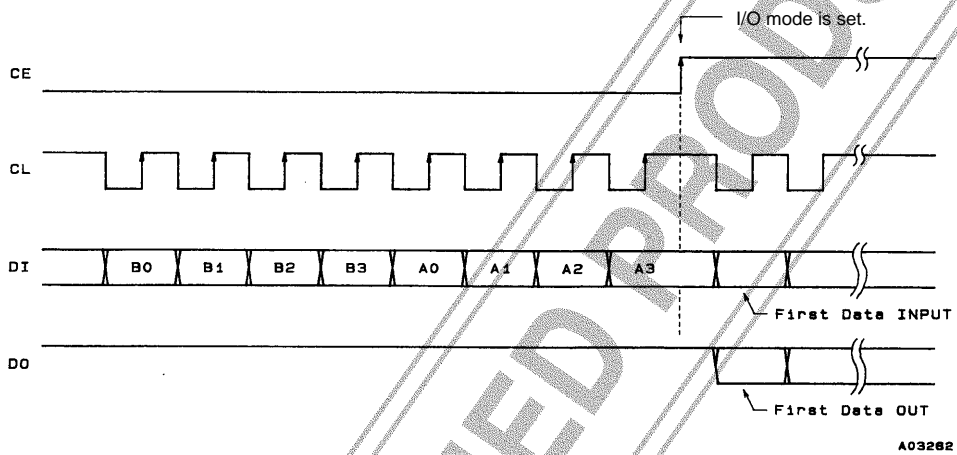

2. Serial Data Input Timing

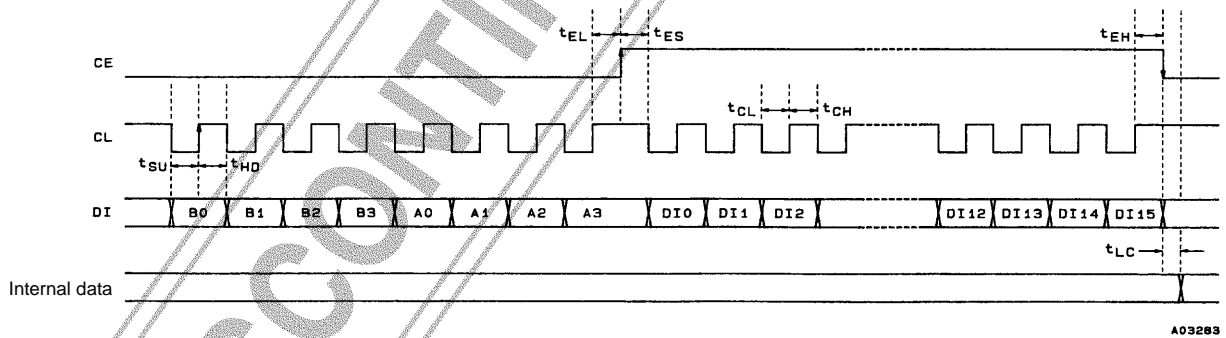

3. Serial Data Output Timing

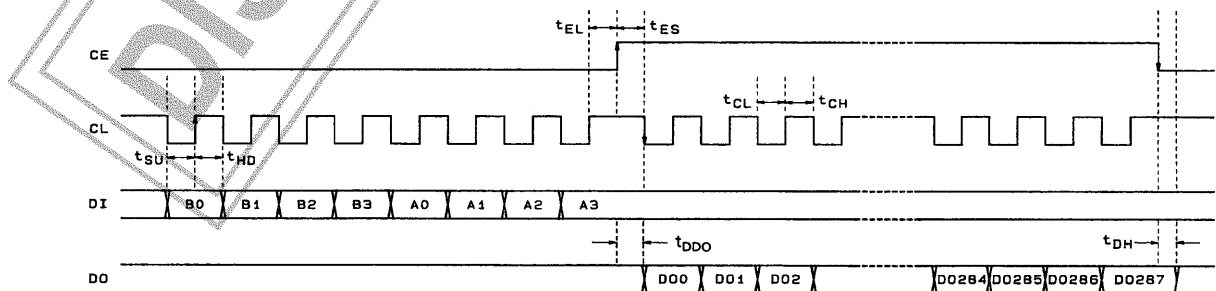

Note: * The DO pin is normally open.
 Since the DO pin is an n-channel open-drain output, the time for the data value to change from the low level to the high level depends on the value of the pull-up resistor used.

4. Serial Control Data Input Setting Values

The input data consists of 16 bits (DI0 to DI15) of which the upper 8 bits (DI8 to DI15) are the control address and the lower 8 bits (DI0 to DI7) are the input data.

Register	Address				Data		Default setting
	DI11	DI10	DI9	DI8			
Allowed error count	0	0	0	0	Upper 4 bits	Back allowed errors	2
					Lower 4 bits	Forward allowed errors	2
Block error protection count	0	0	0	1	Upper 4 bits	Back protection count	1
					Lower 4 bits	Forward protection count	7
Frame error protection count	0	0	1	0	Upper 4 bits	Back protection count	1
					Lower 4 bits	Forward protection count	7
Error correction initial threshold value	0	0	1	1	Upper 5 bits	—	—
					Lower 3 bits	Initial threshold value	7
Readout (output) block number	0	1	0	0	0 to 189 (8 bits)		0

Note: 1. The data in address bits DI12 to DI15 is ignored.

2. The value of the data sent to set the protection count must be one less than the desired protection count. In the default example shown above, the block forward protection count will be 8 and the frame back protection count will be 2. When the value is set to 0, the protection count will be 1. Since a protection count of 0 is meaningless the LSI ignores this value.
3. The initial threshold value is the initial value used when executing error correction at a variable threshold. There is no need to change this value unless some special experiment is being performed. The threshold value can be set to a value from 9 to 15 according to a three-bit field. Therefore a data value of 7 sets the threshold value to 15 and a data value of 1 sets the threshold value to 9.
4. The readout block number is transferred when the skip function is used.
5. Addresses other than those listed above (e.g. 0101) are special addresses unique to this LSI and are for test mode and other functions. These addresses should not be used.
6. The default values are the values loaded into internal registers when a reset signal (RST) is received. These are recommended values and do not require modification in normal operation. If the default values are used then there will be no need to implement control microprocessor software that inputs control data.

DISCONTINUED PRODUCT

Structure of the Output Data

1. The output data consists of a total of 288 bits (36 bytes). The first two bytes are status information.
 2. CNT1 and CNT2 are both output LSB first.
 3. Corrected data is output in order starting with the first bit in each block.
 4. The BIC code is not output.
 5. These points hold for both serial and parallel mode.
- *: The CPU can easily select data by first checking the content of the status information when data is read out. Data that is not required does not have to be read; rather, the CPU can cancel the remainder of the readout operation. (The CPU can simply ignore data until the next interrupt.)

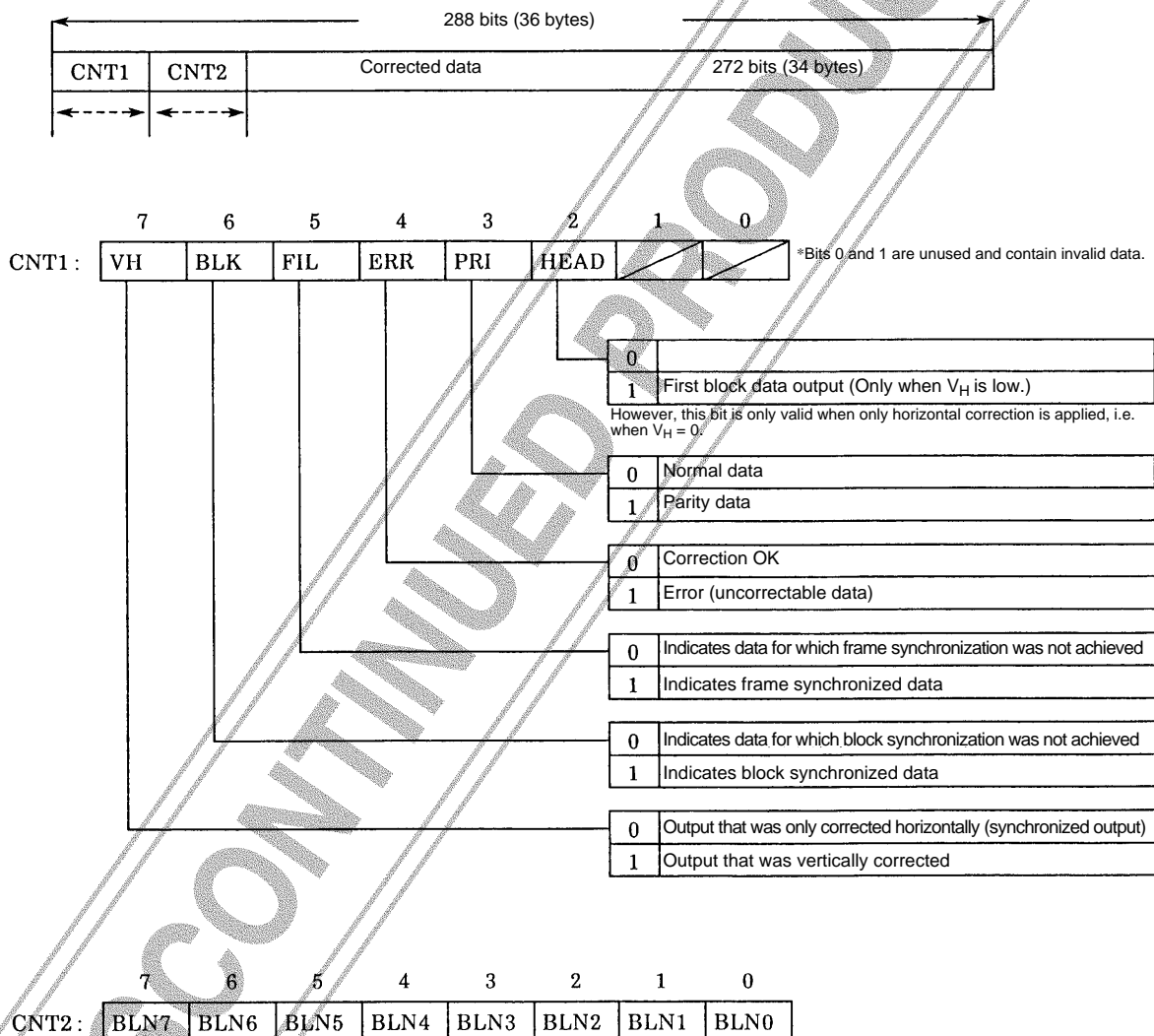

BLN7 to BLN0: Expresses the block number or the parity block number of the output data. The block numbers within a single frame range from 0 to 189, and the parity block numbers from 0 to 81.

Note that parity block data is not output for vertically corrected data.

Parallel Mode Data I/O Methods

Data is input and output using the parallel data interface I/O pins, INT-R (pin 35), RE (pin 25), RDY (pin 26), RDY0 (pin 27) and DATn (pins 13 to 20).

1. Basic Data Output Procedure

- (1) Interrupt handling starts on the falling edge of INT-R.
- (2) Set RE low.
- (3) RDY goes low temporarily and then goes high on output ready.
- (4) After RDY goes high, read in the data from DATn.
- (5) Return RE to high.

Repeat steps (2) to (5) until 36 bytes of data have been read in.

Note: The period that RDY is low is 2.2 μ s (typical). The CPU does not need to monitor RDY if it can adjust its timing. Also, RDY0 is a signal that goes low when output is ready and goes high when RE returns to high. The software logic for data acquisition can be simplified if the RDY (or RDY0) signal is input to the CPU WAIT pin.

2. Parallel Data Output Timing

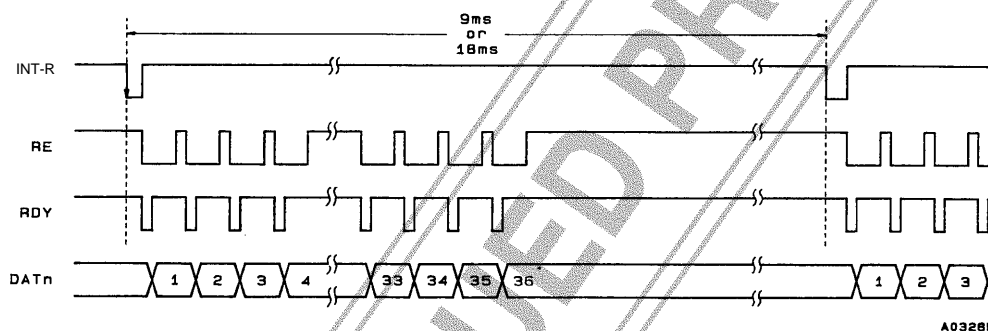

3. Parallel Data Output Timing Stipulations

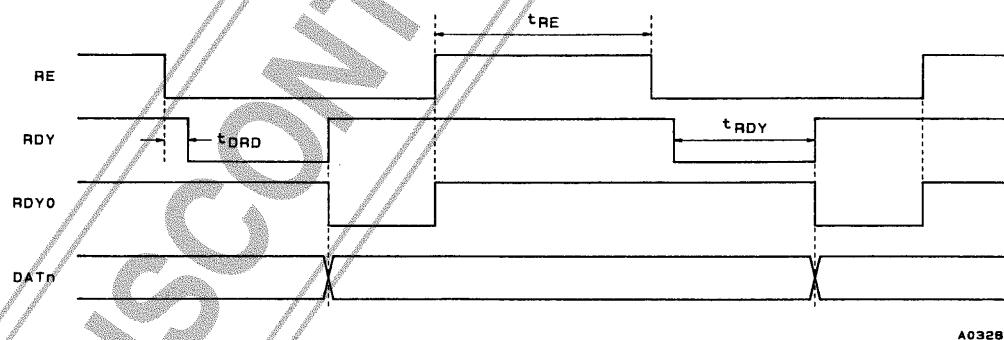

4. Data Input in Parallel Mode

To store data in parallel mode, set the internal register address of the data to be stored in PORT0 to PORT2 (pins 38 to 40) and set the PST pin (pin 37) low. Then input the data to DATn (pins 13 to 20). The PORT0 to PORT2 inputs and the data to be stored are acquired by the LSI on the rising edge of the PST signal. When the PST pin is low, the DAT0 to DAT7 pins function as input pins. Note that the PST pin data store cycle must be 1 μ s or longer.

See the section on page 6 serial data I/O for notes and terminology descriptions concerning the data stored.

LC72700E, LC72700G

PORT2	PORT1	PORT0	Item	Set data		Default value
0	0	0	Allowed error count	Upper 4 bits	Back allowed errors	2
				Lower 4 bits	Forward allowed errors	2
0	0	1	Block error protection count	Upper 4 bits	Back protection count	1
				Lower 4 bits	Forward protection count	7
0	1	0	Frame error protection count	Upper 4 bits	Back protection count	1
				Lower 4 bits	Forward protection count	7
0	1	1	Error correction initial threshold value	Upper 4 bits	—	—
				Lower 3 bits	Initial threshold value	7
1	0	0	Readout block no.	0 to 189 (8 bits)		0

4. Control Data Timing in Parallel Mode

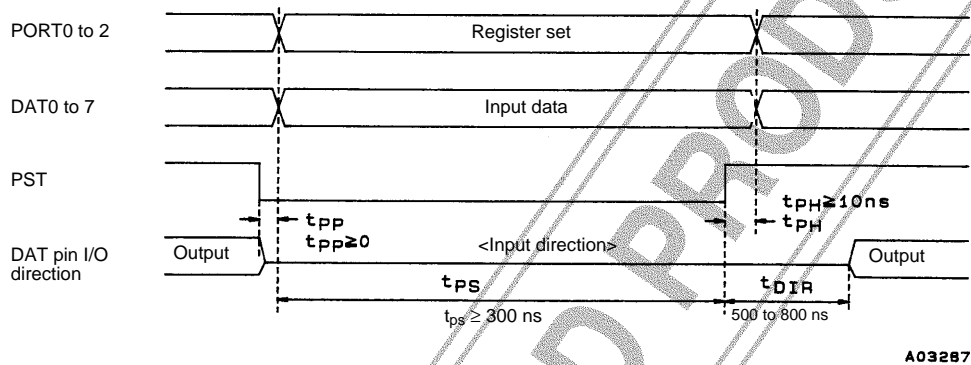

A03287

Handling Pins for the Unused Mode when the CPU Interface is Specified

1. When Serial Mode is Specified

Pin	Pin No.	Pin state	Handling
PST	(37)	Pull-up resistor input	Leave open or connect to the power-supply (V_{DD})
PORT0 to 2	(38 to 40)	Pull-up resistor input	Leave open or connect to the power-supply (V_{DD})
DATA0 to 7	(13 to 20)	Output direction (fixed at the low level)	Leave open
RDY	(26)	Fixed at a high-level output	Leave open
RDY0	(27)	Fixed at a high-level output	Leave open
RE	(25)	Pull-up resistor input	Leave open or connect to the power-supply (V_{DD})

2. When Parallel Mode is Specified

Pin	Pin No.	Pin state	Handling
CL	(29)	Input pin	Connect to the power supply or ground
CE	(30)	Input pin	Connect to the power supply or ground
DI	(31)	Input pin	Connect to the power supply or ground
DO	(32)	Open-drain output in the off state	Connect to ground

- Note:**
1. The data values shown above are for the state immediately following a reset operation.
 2. The INT-R pin (pin 35) signal is always output regardless of the mode.
 3. Since the S/P pin (pin 42) has a built-in pull-up resistor, serial mode will be selected if it is left open.

Circuit Operation at Reset

1. Reset Signal

The reset operation is executed by holding the RST pin input level under V_{IL} for 300 ns or longer when the power-supply voltage (V_{DD}) is over 3.4 volts. (See the figure.)

The reset operation is necessary to run this LSI.

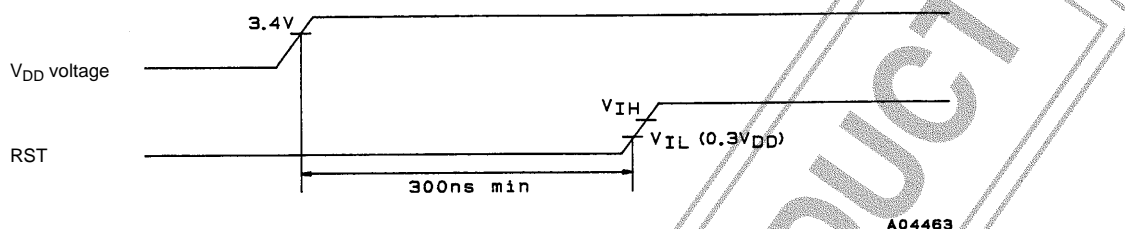

2. Pin Outputs during a Reset

Low-level outputs: ...FILCK (1), CLK (5), DAT0 (13) to DAT7 (20), BCLOCK (21), FCLOCK (22), BL-CK (23), FC-CK (24), D0 (32)

High-level outputs: ...RDY (26), RDYO (27), INT-R (35), XOUT (47)

Note: In serial mode, the DAT0 to DAT7 pins are held at the low level at all times. In parallel mode, these pins output low levels during a reset.

3. Reset Operating Ranges

The output pins are stipulated to operate as described in item 2 above according to a reset signal. All the LSI internal registers go the reset state. While the shift registers for 1T and 2T delay also go to the reset state, memory cells are not affected. However, since the memory refresh operation is stopped, data cannot be maintained. The crystal oscillator circuit is not stopped.

4. Data Input Following a Reset

The serial or the parallel input control circuit becomes capable of operating (accepting data) one clock cycle (about 278 ns at 3.6 MHz: i.e., the LSI's main clock) after the reset completes.

Output Data (basic operation concerning error correction)

Error correction using (272, 190) codes is performed for every block (272 bits) of received data. Data is output immediately after error correction. This is referred to as horizontal correction. If the data could not be corrected by horizontal correction, correction is performed in field units using product codes. This is referred to as vertical correction.

Since the horizontal correction output is output for each received block, it is an effective scheme for applications in which the received data is desired quickly, such as in synchronous broadcasting. Vertical correction is only performed when frame synchronization is achieved. Also, vertical correction is not performed when all the packet (block) data has been completely corrected by horizontal correction. Since vertical correction is performed after one frame (272 blocks) of data has been accumulated, normally about 5 seconds is required from data reception to the output of corrected data.

When post-horizontal correction data is output, all data blocks, including the parity block, are output. Post-vertical correction output data does not include parity block data, but rather only the data in the data blocks (190 blocks of data) is output. Note that when either frame synchronization is not achieved or horizontal correction completes and vertical correction is not performed, the data that is output could be called post-vertical correction data. However, the content of that data will be identical to post-horizontal correction data.

Interface: Basic Control Items

To reduce internal memory requirements this LSI limits the data buffer (RAM) area to the minimum required. Since data received by the LSI is written to the buffer with no gaps, post-correction data that should be read may be overwritten by new data if there are any delays in data readout.

The output timings for vertically and horizontally corrected data for this LSI are stipulated as follows.

1. When the output data is ready, the LSI sets the DO pin low and drops the INT-R pin to low.
2. In data output, there are periods during which only horizontal data can be read out and periods during which horizontal and vertical data can be read out time-division multiplexed.
3. The data transfer must be completed within 9 ms after the DO pin goes low. When only horizontal data is output, data can be transferred during a period of about 18 ms.
Even if the controlling CPU is still reading out data, the data in the output buffer can be overwritten by the next data after the stipulated period has elapsed.
4. The amount of data that can be read in a single transfer request (INT-R) for both vertical and horizontal data is limited to only one block of data.
In principle, vertical data is read out in order starting with block number 1 after vertical correction has completed. Note that the parity block data is not output.

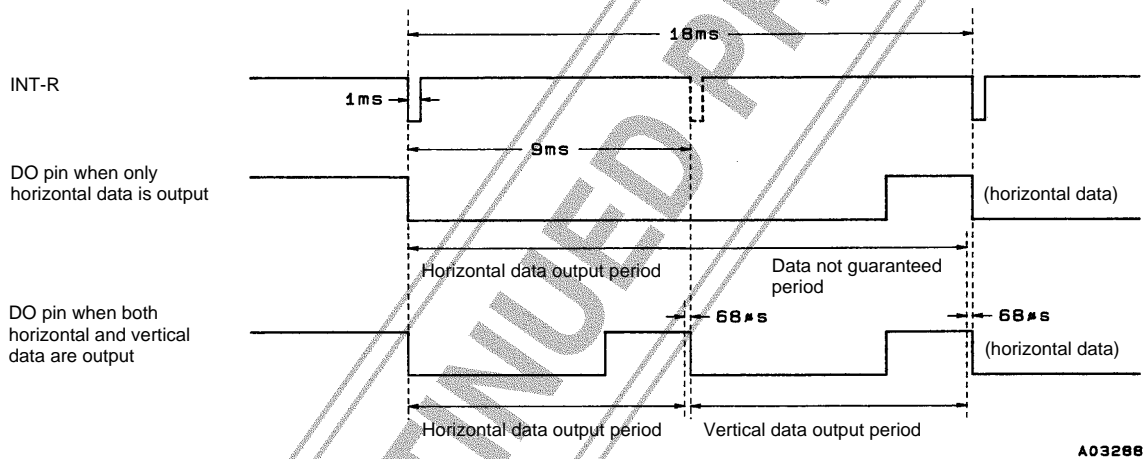

Figure 1 External Interface Basic Timing

Data Output Timing (as related to reception data)

Figure 2 shows the timing relationships between the reception data block start signal (BL-CK: pin 23) and the interrupt control signal (INT-R: pin 25). However, this figure ignores the delay component with respect to the actual received signal due to the demodulation operation in MSK demodulation blocks. Block synchronization is established by recognizing BIC codes. As shown in Figure 2, the data from the nth packet (block) is available for output during reception of the next packet, i.e. packet n+1. When using this LSI, be sure to keep in mind the fact that the block start signal (BL-CK) output by the LSI is output after the BIC code in the actual reception data has been received.

Figure 3 shows the output timing for vertically corrected data. Vertical correction is used when a complete frame of data is stored in memory, frame synchronization is established, and all the data packets could not be corrected by horizontal correction. The frame start defines the timing for the start of vertical correction execution. Horizontal correction is performed for each packet during reception of packets (blocks) 1 to 28 in the nth frame, and data is passed to the CPU interface. Vertical correction is performed for the previous frame (frame n-1) data during the idle periods in the reception process. (However, note that frame and block synchronization must not be lost.)

Vertically corrected data is output at the rate of one block for every block received in order starting with the 29th packet (block). A total of 190 blocks of data are output. Of the data in the FM multiplex broadcast data structure, only the data blocks are output, and the last block, the 190th block is output while the 218th block is being received.

DO (pin 32) Operation (only in serial mode)

Figure 4 shows the changes in the DO signal when data is not output by the CPU. When the output data is ready, DO goes low and returns to the high level about 6 ms later. The data becomes invalid about 9 ms after either DO or INT-R goes low, and data can still be read even after DO goes high. (Horizontal data (only horizontal data) can be read out for a period of about 18 ms.)

The reason DO goes high after 6 ms is so that the CPU interface can handle applications where the CPU does not use the interrupt port.

When DO is low, there is guaranteed to be a window of at least 3 ms during which data can be transferred. (This eases software operation.) INT-R can be used as an edge trigger interrupt. Note that the 68 μ s period prior to the leading edge of INT-R is the LSI's output buffer write period, and that data read during this period is not guaranteed.

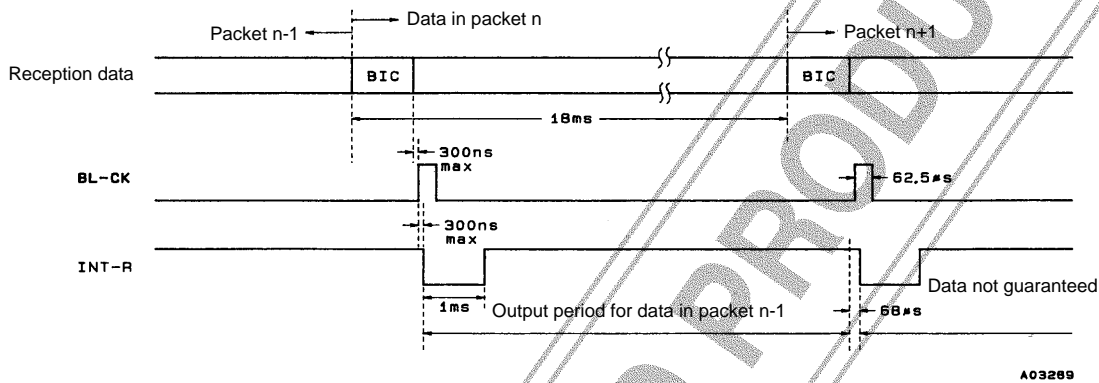

Figure 2 Reception Data, Block Synchronization, and Data Output Timing

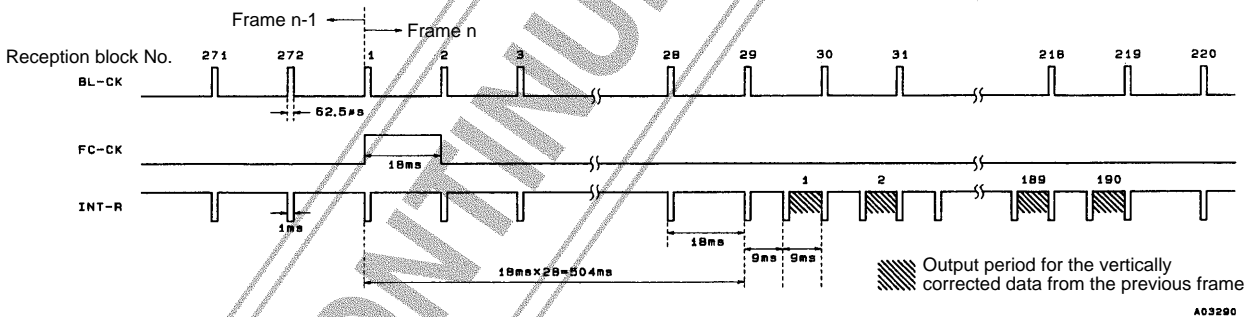

Figure 3 Vertically Corrected Data Output Timing

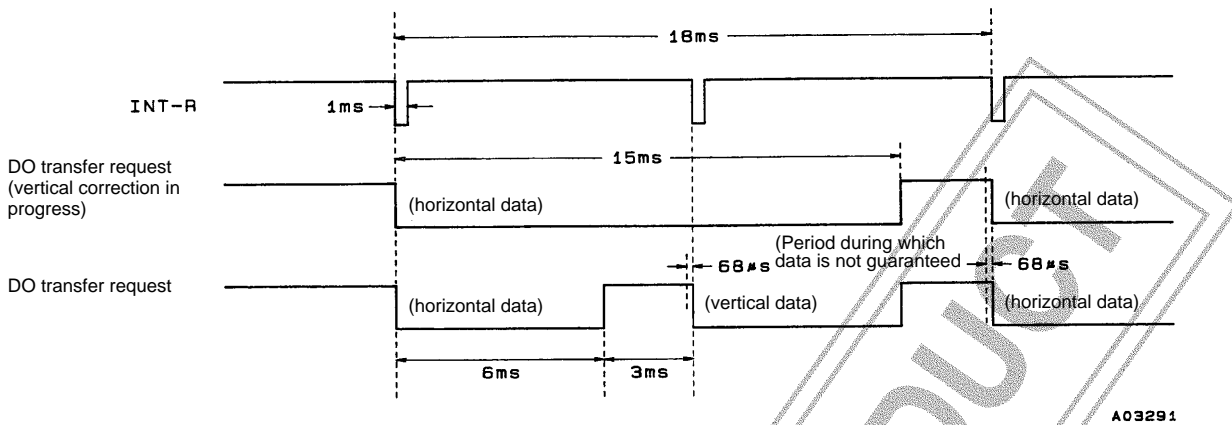

Figure 4 DO Signal Changes when Data is not Output (serial mode)

Skip Function

For post-vertical correction data, only the data block data (190 blocks) can be output.

The skip function jumps over the output data block sequence and allows required data blocks to be output quickly.

However, note that the number specified must be for a block that is ahead of the block currently being read out. If a previous block number is specified, the post-vertical correction output data for that frame cannot be guaranteed. Skip operation is valid during the next post-vertical correction data output after block number specification.

If the skip address is transferred after vertical data output is ready, such as at point B in Figure 5, output data is not skipped at that point, but rather the data skip is performed at the point C, which is the output time for the next vertical data.

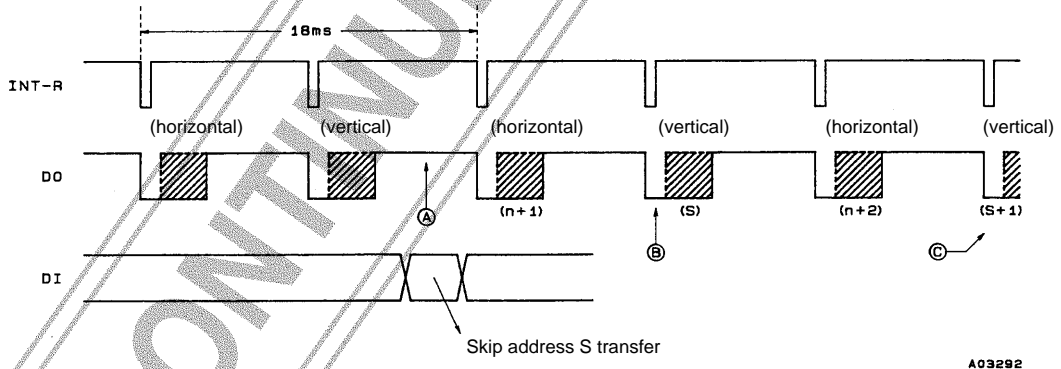

Figure 5 Address Skip

The DARC (Data Radio Channel) FM multiplex broadcast technology was developed by NHK (Japan Broadcasting Corporation). DARC is a registered trademark of NHK Engineering Service (NHK-ES).

A separate contract with NHK-ES is required to produce and market electronic equipment that uses the DARC technology. Note that electronic equipment that uses the DARC technology may display the logo shown elsewhere on this page.



- No products described or contained herein are intended for use in surgical implants, life-support systems, aerospace equipment, nuclear power control systems, vehicles, disaster/crime-prevention equipment and the like, the failure of which may directly or indirectly cause injury, death or property loss.
- Anyone purchasing any products described or contained herein for an above-mentioned use shall:
 - ① Accept full responsibility and indemnify and defend SANYO ELECTRIC CO., LTD., its affiliates, subsidiaries and distributors and all their officers and employees, jointly and severally, against any and all claims and litigation and all damages, cost and expenses associated with such use:
 - ② Not impose any responsibility for any fault or negligence which may be cited in any such claim or litigation on SANYO ELECTRIC CO., LTD., its affiliates, subsidiaries and distributors or any of their officers and employees jointly or severally.
- Information (including circuit diagrams and circuit parameters) herein is for example only; it is not guaranteed for volume production. SANYO believes information herein is accurate and reliable, but no guarantees are made or implied regarding its use or any infringements of intellectual property rights or other rights of third parties.

This catalog provides information as of July, 1997. Specifications and information herein are subject to change without notice.