

## GaAs InGaP HBT MMIC BROADBAND AMPLIFIER GAIN BLOCK, DC - 6.0 GHz

### Typical Applications

Ideal as a Driver & Amplifier for:

- 2.2 - 2.7 GHz MMDS
- 3.5 GHz Wireless Local Loop
- 5.0 - 6.0 GHz UNII & HiperLAN

### Features

- P1dB Output Power: +14 dBm
- Output IP3: +27 dBm
- Gain: 17 dB
- Single Supply: +5V
- High Reliability GaAs HBT Process
- Ultra Small Package: SOT26

### Functional Diagram

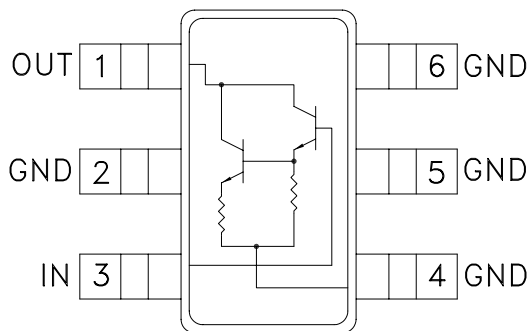

### General Description

The HMC313 is a GaAs InGaP Heterojunction Bipolar Transistor (HBT) MMIC amplifier that operates from a single Vcc supply. The surface mount SOT26 amplifier can be used as a broadband gain stage or used with external matching for optimized narrow band applications. With Vcc biased at +5V, the HMC313 offers 17 dB of gain and +15 dBm of saturated power while only requiring 50 mA of current. The “HMC313 Biasing and Impedance Matching Techniques” application note available within the “Application Notes” section offers recommendations for narrow band operation.

### Electrical Specifications, $T_A = +25^\circ\text{C}$

Parameter	Vcc = +5V			Units
	Min.	Typ.	Max.	
Frequency Range	DC - 6			GHz
Gain	14	17	20	dB
Gain Variation Over Temperature		0.02	0.03	dB/°C
Input Return Loss		7		dB
Output Return Loss		6		dB
Reverse Isolation		30		dB
Output Power for 1 dB Compression (P1dB) @ 1.0 GHz	11	14		dBm
Saturated Output Power (Psat) @ 1.0 GHz		15		dBm
Output Third Order Intercept (IP3) @ 1.0 GHz	24	27		dBm
Noise Figure		6.5		dB
Supply Current (Icc)		50		mA

## GaAs InGaP HBT MMIC BROADBAND AMPLIFIER GAIN BLOCK, DC - 6.0 GHz

**Gain & Return Loss**

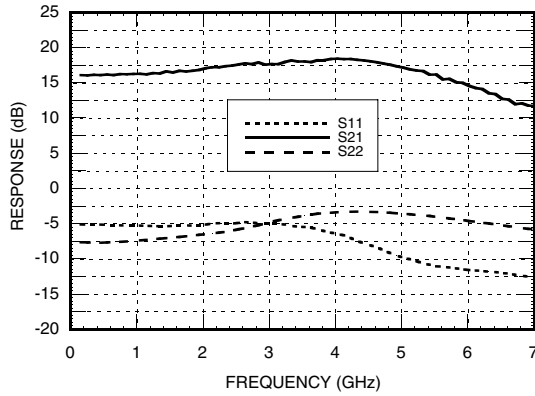

**Gain vs. Temperature**

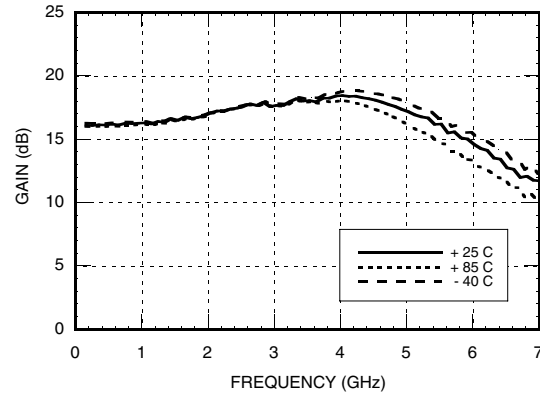

**Input & Output Return Loss**

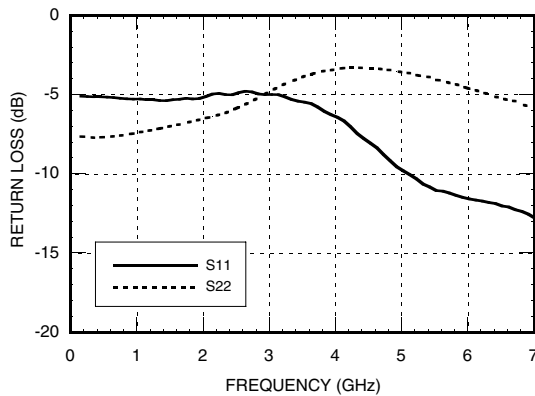

**Reverse Isolation**

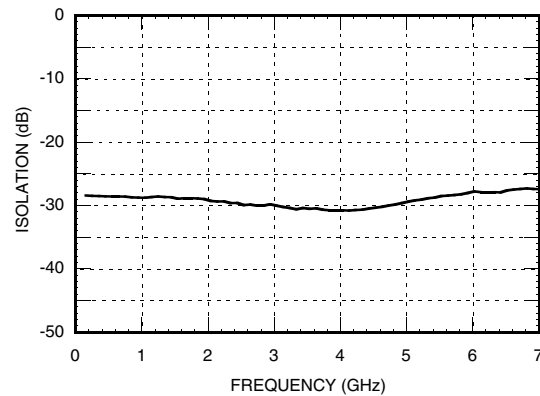

**P1dB vs. Temperature**

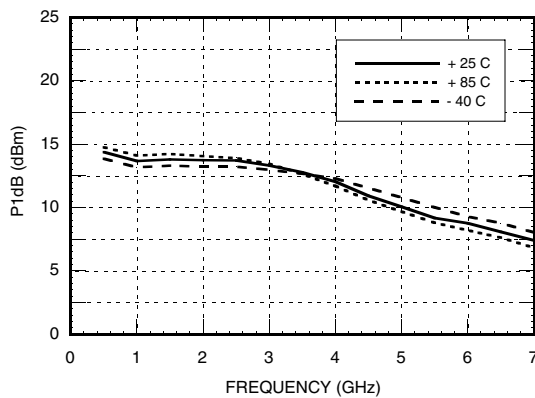

**Psat vs. Temperature**

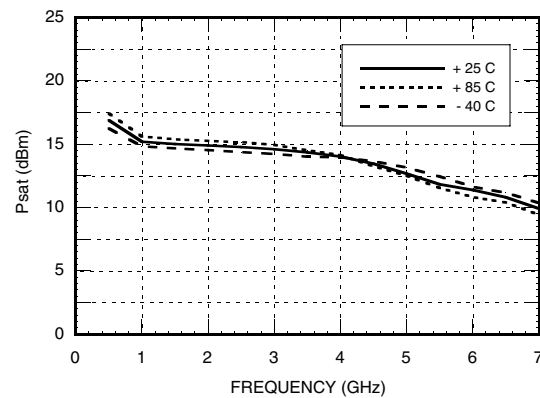

## GaAs InGaP HBT MMIC BROADBAND AMPLIFIER GAIN BLOCK, DC - 6.0 GHz

8

AMPLIFIERS - SMT

**Output IP3 vs. Temperature**

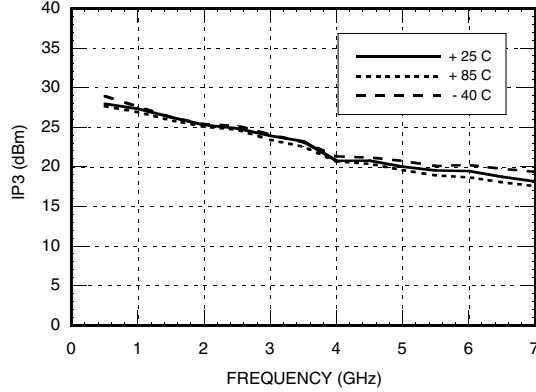

**Power Compression @ 1.0 GHz**

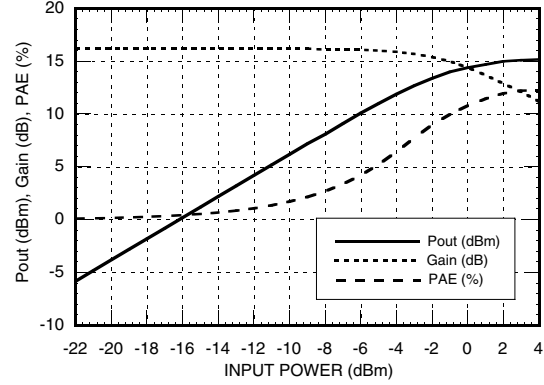

**Power Compression @ 3.0 GHz**

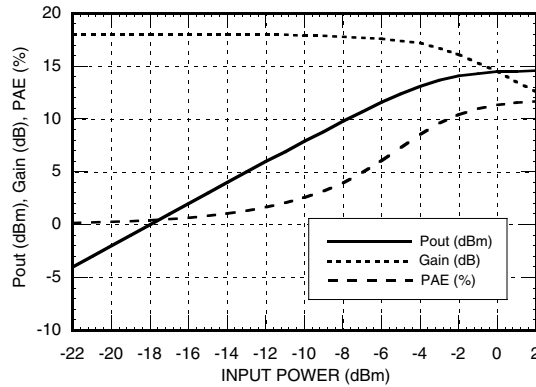

## GaAs InGaP HBT MMIC BROADBAND AMPLIFIER GAIN BLOCK, DC - 6.0 GHz

### Absolute Maximum Ratings

Collector Bias Voltage (Vcc)	+5.5 Vdc
RF Input Power (RFin)(Vcc = +5.0 Vdc)	+20 dBm
Junction Temperature	150 °C
Continuous P <sub>diss</sub> (T = 85 °C) (derate 3.99 mW/°C above 85 °C)	0.259 W
Thermal Resistance (junction to lead)	251 °C/W
Storage Temperature	-65 to +150 °C
Operating Temperature	-40 to +85 °C

### Absolute Maximum Ratings

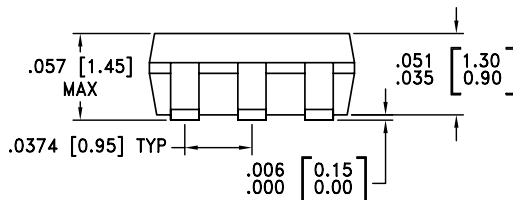
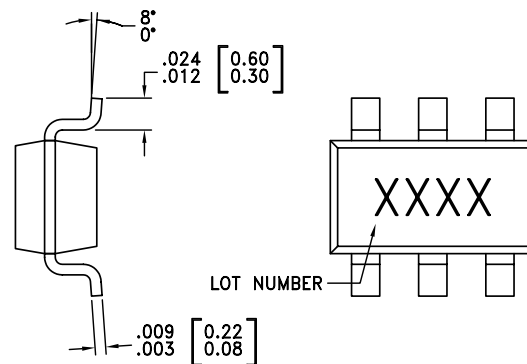
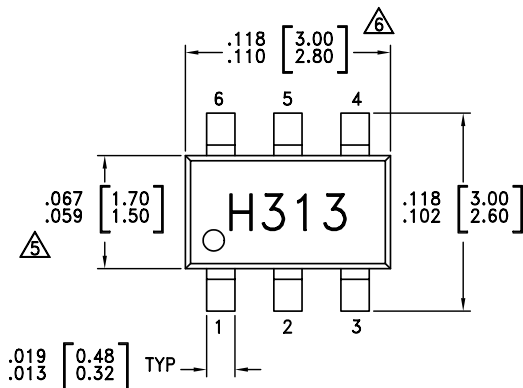



NOTES:

- PACKAGE BODY MATERIAL: LOW STRESS INJECTION MOLDED PLASTIC SILICA AND SILICON IMPREGNATED.
- LEADFRAME MATERIAL: COPPER ALLOY
- LEADFRAME PLATING: Sn/Pb SOLDER
- DIMENSIONS ARE IN INCHES [MILLIMETERS].
- $\triangle 5$  DIMENSION DOES NOT INCLUDE MOLDFLASH OF 0.15mm PER SIDE.
- $\triangle 6$  DIMENSION DOES NOT INCLUDE MOLDFLASH OF 0.25mm PER SIDE.
- ALL GROUND LEADS MUST BE SOLDERED TO PCB RF GROUND.

## GaAs InGaP HBT MMIC BROADBAND AMPLIFIER GAIN BLOCK, DC - 6.0 GHz

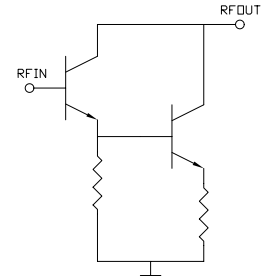
### Pin Descriptions

Pin Number	Function	Description	Interface Schematic
1	RFOUT	This pin is DC coupled. An off chip DC blocking capacitor is required.	
3	RFIN	This pin is DC coupled. An off chip DC blocking capacitor is required.	
2, 4-6	GND	These pins must be connected to RF/DC ground.	

### Application Circuit

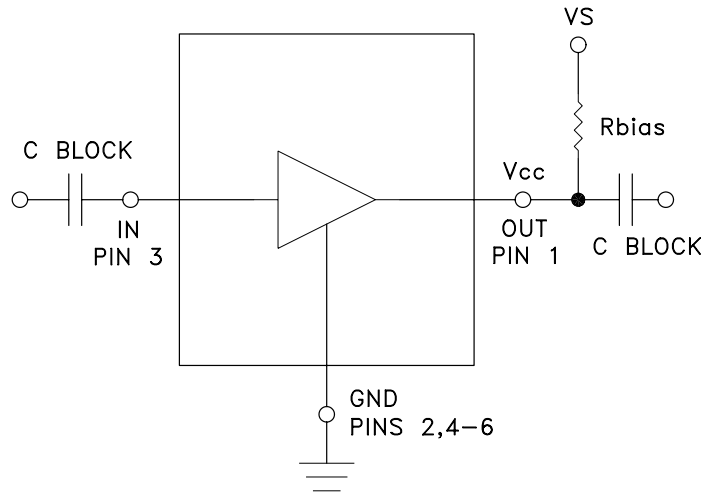

**Note:**

1. Select *Rbias* to achieve desired *Vcc* voltage on Pin 1.
2. External Blocking Capacitors are required on Pins 1 & 3.
3. See "Application Notes" section for HMC313 Application Circuit.

## GaAs InGaP HBT MMIC BROADBAND AMPLIFIER GAIN BLOCK, DC - 6.0 GHz

### Evaluation PCB

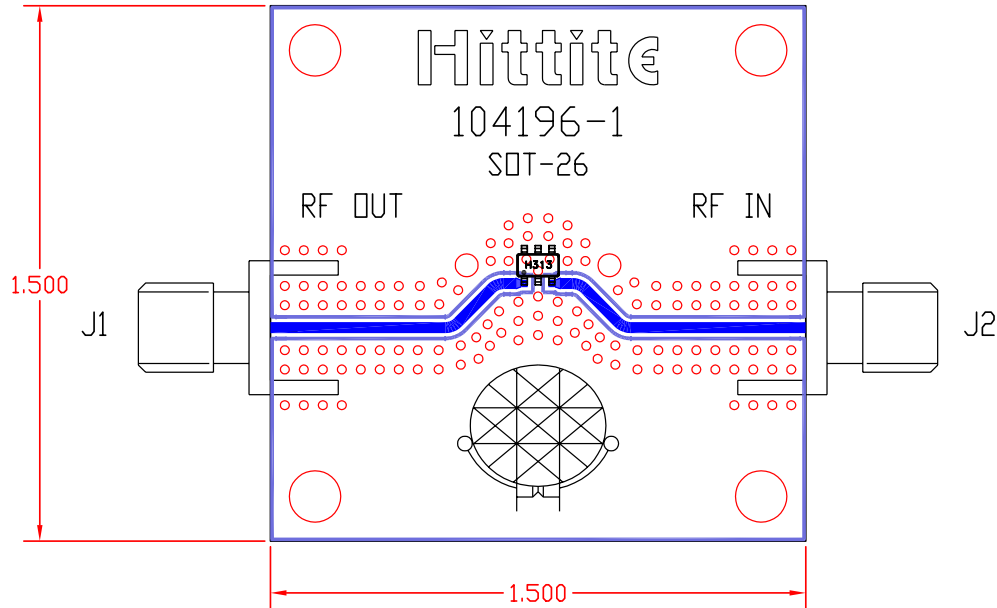

### List of Material

Item	Description
J1 - J2	PC Mount SMA Connector
U1	HMC313
PCB*	Evaluation PCB 1.5" x 1.5"
*Circuit Board Material: Roger 4350	

The circuit board used in the final application should use RF circuit design techniques. Signal lines should have 50 ohm impedance while the package ground leads should be connected directly to the ground plane similar to that shown. A sufficient number of via holes should be used to connect the top and bottom ground planes. The evaluation circuit board shown is available from Hittite upon request.

The "HMC313 Biasing and Impedance Matching Techniques" application note is located in the "Application Notes" section of this Designers' Guide.