

## PNP Silicon AF and Switching Transistors

**BCX 42**  
**BSS 63**

- For general AF applications
- High breakdown voltage
- Low collector-emitter saturation voltage
- Complementary types: BCX 41, BSS 64 (NPN)

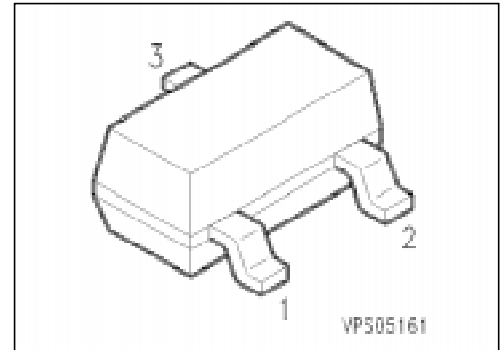

Type	Marking	Ordering Code (tape and reel)	Pin Configuration			Package <sup>1)</sup>
			1	2	3	
BCX 42 BSS 63	DKs BMs	Q62702-C1485 Q62702-S534	B	E	C	SOT-23

### Maximum Ratings

Parameter	Symbol	Values		Unit
		BSS 63	BCX 42	
Collector-emitter voltage	$V_{CE0}$	100	125	V
Collector-base voltage	$V_{CB0}$	110	125	
Emitter-base voltage	$V_{EB0}$	5	5	
Collector current	$I_C$	800		mA
Peak collector current	$I_{CM}$	1		A
Base current	$I_B$	100		mA
Peak base current	$I_{BM}$	200		
Total power dissipation, $T_s = 79\text{ °C}$	$P_{tot}$	330		mW
Junction temperature	$T_j$	150		°C
Storage temperature range	$T_{stg}$	- 65 ... + 150		

### Thermal Resistance

Junction - ambient <sup>2)</sup>	$R_{th\ JA}$	≤ 285	K/W
Junction - soldering point	$R_{th\ JS}$	≤ 215	

<sup>1)</sup> For detailed information see chapter Package Outlines.

<sup>2)</sup> Package mounted on epoxy pcb 40 mm × 40 mm × 1.5 mm/6 cm<sup>2</sup> Cu.

## Electrical Characteristics

at  $T_A = 25\text{ °C}$ , unless otherwise specified.

Parameter	Symbol	Values			Unit
		min.	typ.	max.	

### DC characteristics

Collector-emitter breakdown voltage $I_C = 10\text{ mA}$	BCX 42 BSS 63	$V_{(BR)CE0}$	125 100	– –	– –	V
Collector-base breakdown voltage <sup>1)</sup> $I_C = 100\text{ }\mu\text{A}$	BCX 42 BSS 63	$V_{(BR)CB0}$	125 110	– –	– –	
Emitter-base breakdown voltage, $I_E = 10\text{ }\mu\text{A}$		$V_{(BR)EB0}$	5	–	–	
Collector cutoff current $V_{CB} = 80\text{ V}$	BSS 63	$I_{CB0}$	–	–	100	nA
$V_{CB} = 100\text{ V}$	BCX 42		–	–	100	nA
$V_{CB} = 80\text{ V}, T_A = 150\text{ °C}$	BSS 63		–	–	20	$\mu\text{A}$
$V_{CB} = 100\text{ V}, T_A = 150\text{ °C}$	BCX 42		–	–	20	$\mu\text{A}$
Collector cutoff current $V_{CE} = 100\text{ V}$		$I_{CE0}$				$\mu\text{A}$
$T_A = 85\text{ °C}$	BCX 42		–	–	10	
$T_A = 125\text{ °C}$	BCX 42		–	–	75	
Emitter cutoff current, $V_{EB} = 4\text{ V}$		$I_{EB0}$	–	–	100	nA
DC current gain <sup>1)</sup> $I_C = 100\text{ }\mu\text{A}, V_{CE} = 1\text{ V}$	BCX 42	$h_{FE}$	25	–	–	–
$I_C = 10\text{ mA}, V_{CE} = 5\text{ V}$	BSS 63		30	–	–	
$I_C = 20\text{ mA}, V_{CE} = 5\text{ V}$	BSS 63		30	–	–	
$I_C = 100\text{ mA}, V_{CE} = 1\text{ V}$	BCX 42		63	–	–	
$I_C = 200\text{ mA}, V_{CE} = 1\text{ V}$	BCX 42		40	–	–	
Collector-emitter saturation voltage <sup>1)</sup> $I_C = 300\text{ mA}, I_B = 30\text{ mA}$	BCX 42	$V_{CEsat}$	–	–	0.9	V
$I_C = 25\text{ mA}, I_B = 2.5\text{ mA}$	BSS 63		–	–	0.25	
$I_C = 75\text{ mA}, I_B = 7.5\text{ mA}$	BSS 63		–	–	0.9	
Base-emitter saturation voltage <sup>1)</sup> $I_C = 300\text{ mA}, I_B = 30\text{ mA}$	BCX 42	$V_{BEsat}$	–	–	1.4	

### AC characteristics

Transition frequency $I_C = 20\text{ mA}, V_{CE} = 5\text{ V}, f = 20\text{ MHz}$		$f_t$	–	150	–	MHz
Output capacitance $V_{CB} = 10\text{ V}, f = 1\text{ MHz}$		$C_{obo}$	–	12	–	pF

1) Pulse test:  $t \leq 300\text{ }\mu\text{s}, D = 2\text{ %}$

### Total power dissipation $P_{tot} = f(T_A^*; T_S)$

\* Package mounted on epoxy

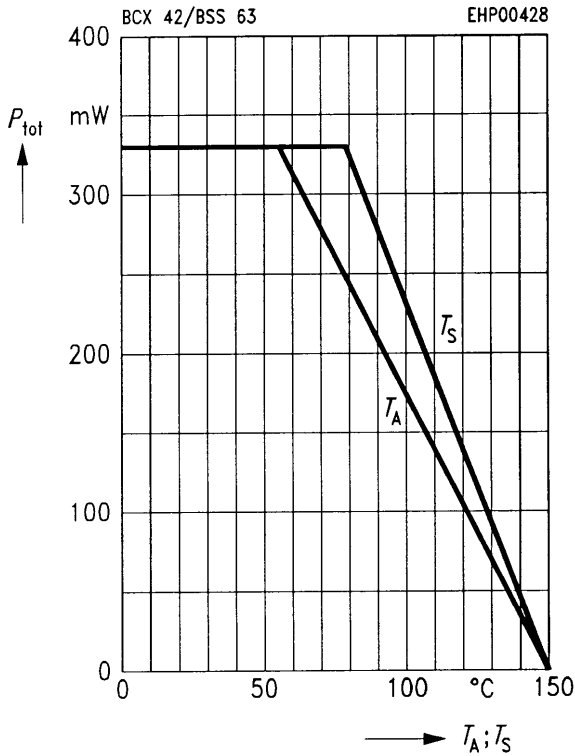

### Collector current $I_C = f(V_{BE})$

$V_{CE} = 1 V$

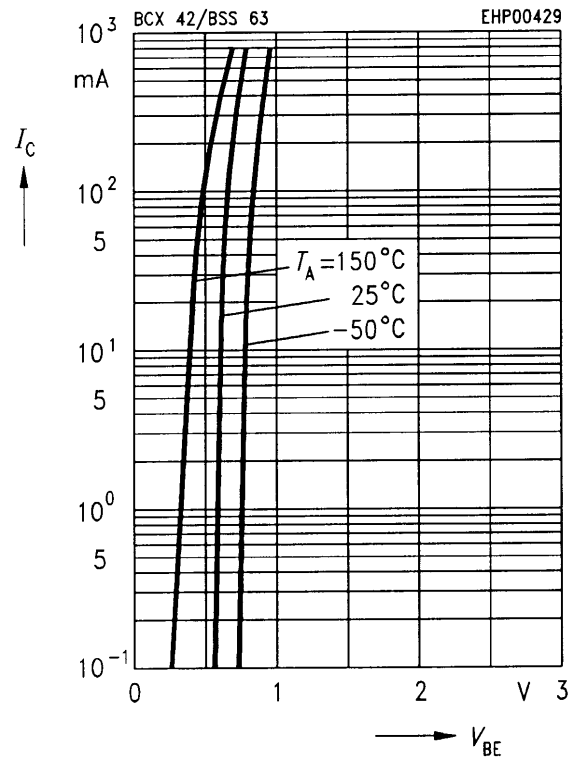

### Permissible pulse load $P_{tot max}/P_{tot DC} = f(t_p)$

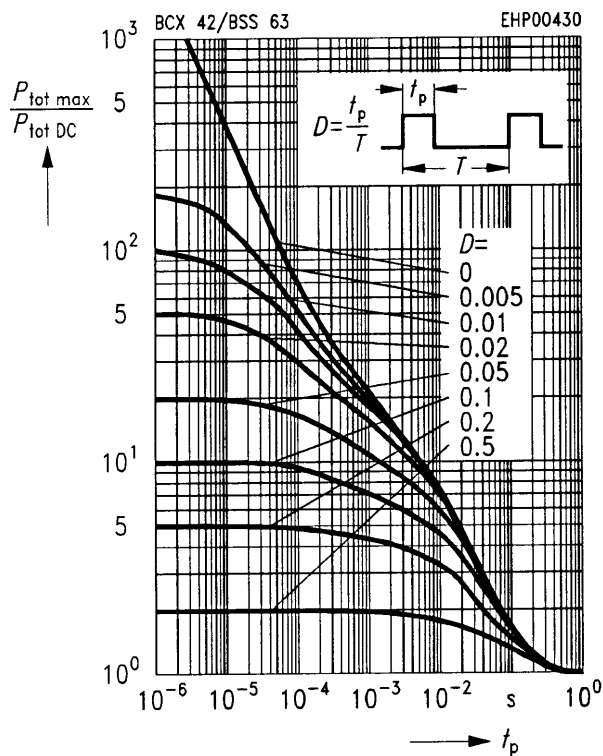

### Transition frequency $f_T = f(I_C)$

$V_{CE} = 5 V$

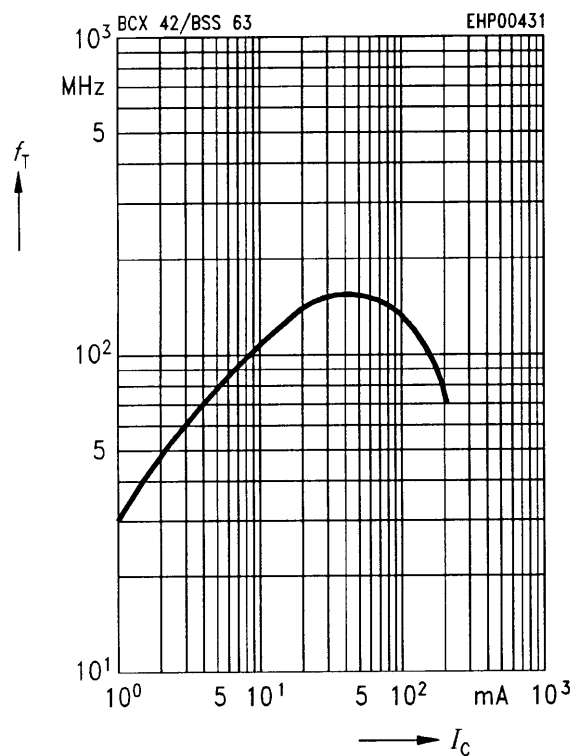

**Base-emitter saturation voltage**

$I_C = f(V_{BEsat})$

$h_{FE} = 10$

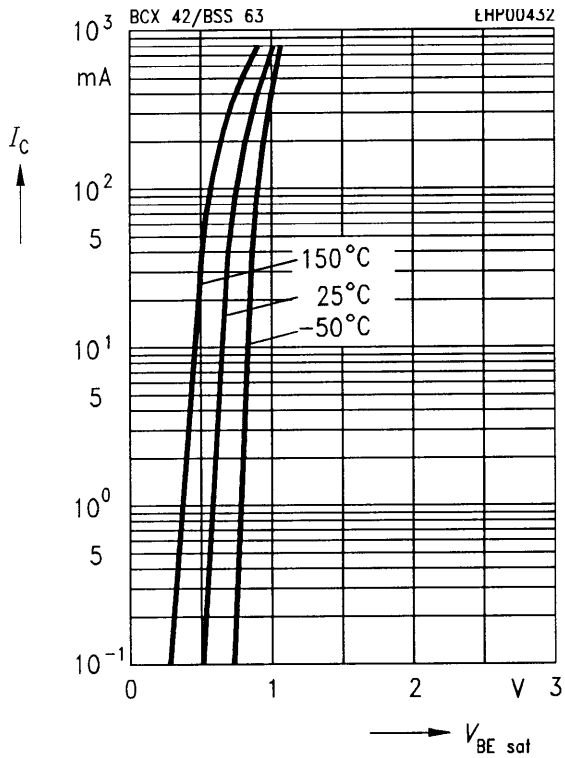

**Collector-emitter saturation voltage**

$I_C = f(V_{CEsat})$

$h_{FE} = 10$

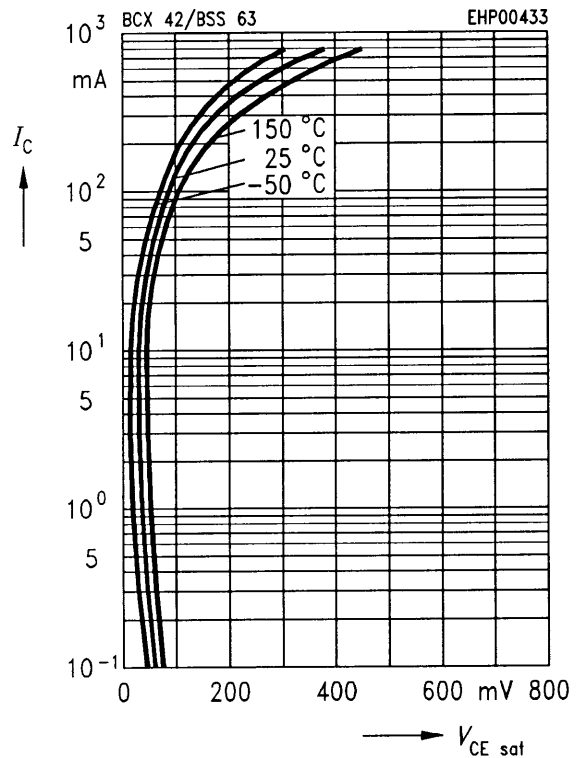

**Collector cutoff current  $I_{CB0} = f(T_A)$**

$V_{CB} = V_{CEmax}$

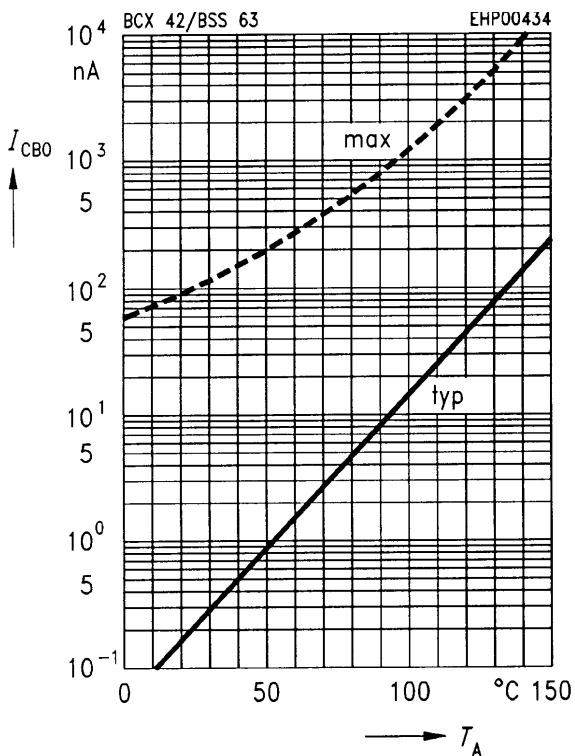

**DC current gain  $h_{FE} = f(I_C)$**

$V_{CE} = 1 V$

