

20A ULTRA FAST RECOVERY RECTIFIER

CASE : ITO-220AC(UFF200-xx), FULLY INSULATED PACKAGE

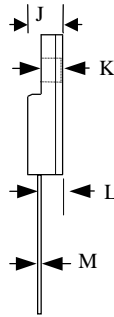
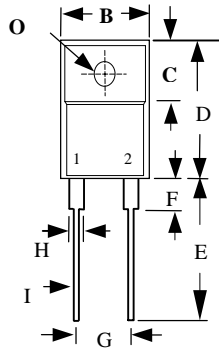

PIN 1 ← → PIN 2
CASE

	MILLIMETERS	
	MIN	MAX
B	9.72	10.27
C	6.30	6.90
D	14.50	15.50
E	13.00	13.80
F	-	4.1
G	4.95	5.20
H	-	1.52
I	-	0.9
J	-	4.8
K	-	3.1
L	2.5	2.9
M	-	0.8
O	-	Ø 3.4

FEATURES

- ULTRA FAST RECOVERY TIME
- LOW FORWARD VOLTAGE
- LOW THERMAL RESISTANCE
- HIGH CURRENT CAPABILITY
- HIGH VOLTAGE
- GLASS PASSIVATED CHIP JUNCTION

MECHANICAL DATA

- CASE : TRANSFER MOLDED
- TERMINAL : MIL-STD-202F METHOD 208
- POLARITY : AS MARKED
- EPOXY : UL94V-0 FLAME RETARDANT MOLDING COMPOUND
- WEIGHT : 1.81 GRAMS

MAXIMUM RATINGS AND ELECTRICAL CHARACTERISTICS

RATINGS AT 25°C AMBIENT TEMPERATURE UNLESS OTHERWISE SPECIFIED
SINGLE PHASE, HALF WAVE, 60 HZ, RESISTIVE OR INDUCTIVE LOAD.
FOR CAPACITIVE LOAD, DERATE CURRENT BY 20%

RATINGS	SYMBOL	UFF200-005	UFF200-01	UFF200-02	UFF200-03	UFF200-04	UFF200-05	UFF200-06	UNITS
MAXIMUM RECURRENT PEAK REVERSE VOLTAGE	V_{RRM}	50	100	200	300	400	500	600	V
MAXIMUM RMS VOLTAGE	V_{RMS}	35	70	140	210	280	350	420	V
MAXIMUM DC BLOCKING VOLTAGE	V_{DC}	50	100	200	300	400	500	600	V
MAXIMUM AVERAGE FORWARD RECTIFIED CURRENT SEE FIG.1	I_O	20.0							A
PEAK FORWARD SURGE CURRENT, 8.3ms SINGLE HALF SINE-WAVE SUPERIMPOSED ON RATED LOAD	I_{FSM}	250							A
TYPICAL JUNCTION CAPACITANCE (NOTE 1)	C_J	65							PF
TYPICAL THERMAL RESISTANCE (NOTE 2)	$R_{\theta jc}$	2.2							°C/W
STORAGE TEMPERATURE RANGE	T_{STG}	- 55 TO + 150							°C
OPERATING TEMPERATURE RANGE	T_{OP}	- 55 TO + 150							°C

ELECTRICAL CHARACTERISTICS (At $T_A = 25^\circ\text{C}$ UNLESS OTHERWISE NOTED)

CHARACTERISTICS	SYMBOL	UFF200-005	UFF200-01	UFF200-02	UFF200-03	UFF200-04	UFF200-05	UFF200-06	UNITS
MAXIMUM FORWARD VOLTAGE AT I_O DC	V_F	1.00		1.30		1.50			V
MAXIMUM DC REVERSE CURRENT AT $T_A = 25^\circ\text{C}$	I_R	10							μA
MAXIMUM DC REVERSE CURRENT AT $T_A = 100^\circ\text{C}$	I_R	100							μA
MAXIMUM REVERSE RECOVERY TIME (NOTE 3)	T_{RR}	35			50				nS

- NOTES : 1. MEASURED AT 1 MHZ AND APPLIED REVERSE VOLTAGE OF 4.0 VOLTS
2. THERMAL RESISTANCE JUNCTION TO CASE PER LEG MOUNTED ON HEATSINK
3. REVERSE RECOVERY TEST CONDITIONS: $I_F = 0.5\text{A}$, $I_R = 1.0\text{A}$, $I_{RR} = 0.25\text{A}$

RATINGS AND CHARACTERISTIC CURVE UFF200-005 THRU UFF200-06

FIG. 1 - TEST CIRCUIT DIAGRAM AND REVERSE RECOVERY TIME CHARACTERISTIC

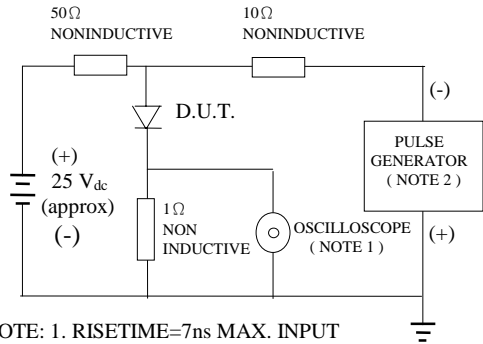

NOTE: 1. RISE TIME = 7 ns MAX. INPUT IMPEDANCE = 1 MEGOHM 22PF
 2. RISE TIME = 10 ns MAX. SOURCE IMPEDANCE = 50 OHMS

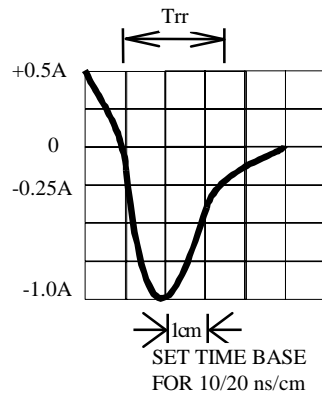

FIG. 2 - TYPICAL FORWARD CURRENT DERATING CURVE

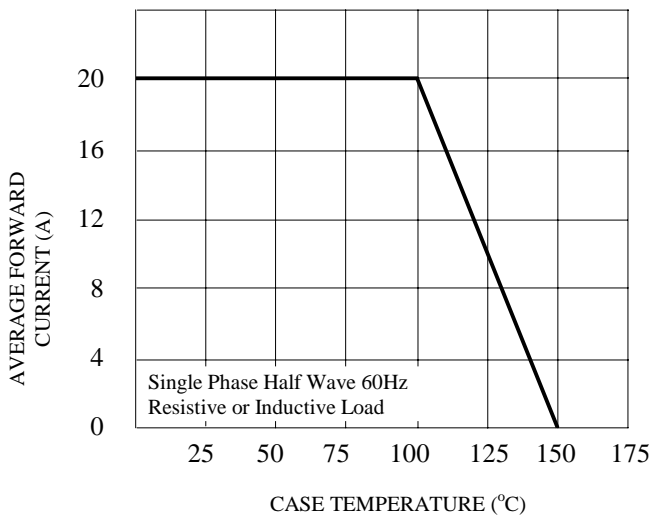

FIG. 3 - TYPICAL INSTANTANEOUS FORWARD CHARACTERISTICS

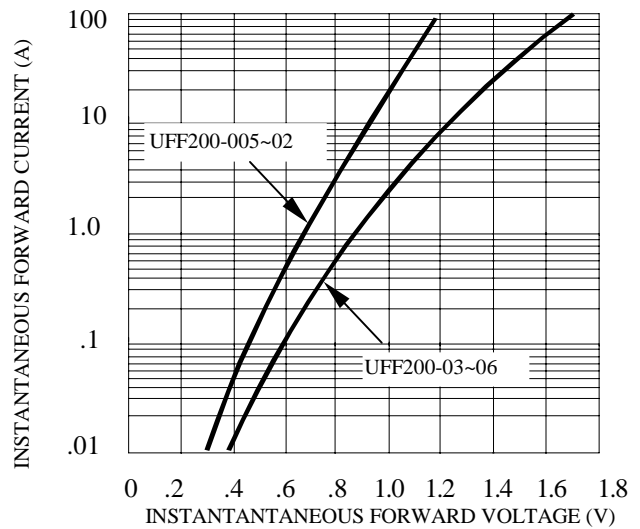

FIG. 4 - TYPICAL REVERSE CHARACTERISTICS

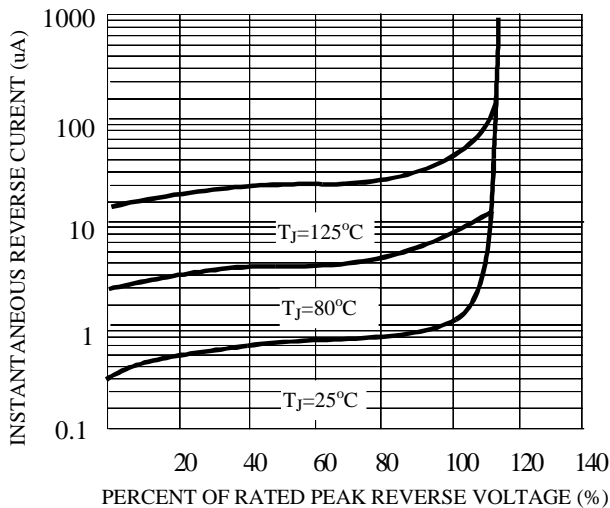

FIG. 5 - TYPICAL JUNCTION CAPACITANCE

