



SPX8863

120 mA, Low Dropout Voltage Regulator (Preliminary Information)

FEATURES

- Low Noise Output LDO
- 1% Initial Accuracy At 120mA
- Very Low Quiescent Current
- Low Dropout Voltage
- Current & Thermal Limiting
- Reverse-Battery Protection
- Wide Range of Fix Output Voltages
1.8V, 2.5V, 2.8V, 3.0V, 3.3V, 4.0V, 4.5V, 5.0V, & ADJ
- Zero Off-Mode Current
- Small 5-Pin SOT-23
- Pin Compatible to MAX8863

APPLICATIONS

- PDA
- Battery Powered Systems
- Cellular Phone
- Cordless Telephones
- Radio Control Systems
- Portable/Palm Top/Notebook Computers
- Portable Consumer Equipment
- Portable Instrumentation
- Bar Code Scanners
- SMPS Post-Regulator

PRODUCT DESCRIPTION

The SPX8863 is a low-power positive voltage regulator with ultra low noise output and very low dropout voltage. In addition, this device offers very low quiescent current of approximately 600uA at 100mA output. The SPX8863 initial tolerance is less than 1% max and has a logic compatible ON/OFF switching input. The unique features of the SPX8863 include a reference bypass pin for the best performance results of low noise.

This device is an excellent choice for use in battery powered applications such as cellular/ cordless telephones, radio control systems, and portable computers. When disabled power consumption drops to nearly zero. The device also has a very low output temperature coefficient, making it a low power voltage reference. The SPX8863 key features include protection against reversed battery, fold-back current limiting, and automotive load dump protection.

The SPX8863 is available in many fixed voltages (1.8V, 2.5V, 2.8V, 3.0V, 3.3V, 4.0V, 4.5V, & 5.0V) or with an adjustable output. This device is offered in a small 5-pin SOT-23 package, providing a small footprint with all the performance features with fixed or adjustable output.

MARKING INFORMATION

Voltage	Marking	Voltage	Marking
1.8	9WXX	4.5	A4XX
2.5	9XXX	4.70	A5XX
2.8	9YXX	5.0	A6XX
3.0	A3XX	ADJ	A7XX
3.3	A2XX		

PIN CONNECTIONS

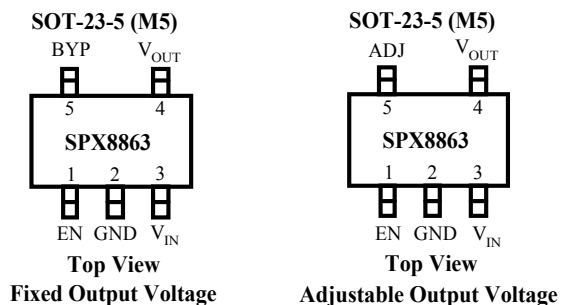

ABSOLUTE MAXIMUM RATINGS

Power Dissipation.....	Internally Limited
Lead Temp. (Soldering, 5 Seconds)	260°C
Operating Junction Temperature Range	-40°C to +125°C
Input Supply Voltage.....	-20V to +20V
Enable Input Voltage.....	-20V to +20V

RECOMMENDED OPERATING CONDITIONS

Input Voltage.....	+2.5V to +16V
Operating Junction Temperature Range	-40°C to +125°C
Enable Input Voltage.....	0V to V_{IN}
SOT-23-5 (θ_{JA})	See Note 1

ELECTRICAL CHARACTERISTICS

$T_J = 25^\circ\text{C}$, $V_{IN} = V_{OUT} + 1\text{V}$, $I_L = 100\mu\text{A}$, $C_L = 1.0\mu\text{F}$, and $V_{ENABLE} \geq 2.4\text{V}$. Unless otherwise specified **boldface** applies over the junction temperature range

Parameter	Test Conditions	Typ	Min	Max	Units
Output Voltage Tolerance (V_{OUT})	$I_L = 100\mu\text{A}$ $I_L = 500\mu\text{A}$		-1 -2	+1 +2	$\%V_{NOM}$
Output Voltage Temperature Coef		40			ppm/°C
Line Regulation	$V_{IN} = V_{OUT} + 1\text{V}$ to 16V $V_{IN} = V_{OUT} + 1\text{V}$ to 16V	0.03		0.1 0.2	%/V
Load Regulation	$I_L = 0.1\text{mA}$ to 120mA $I_L = 0.1\text{mA}$ to 120mA	0.1		0.2 0.5	%
Dropout Voltage (See Note 2) ($V_{IN} - V_O$)	$I_L = 100\mu\text{A}$	30		50	mV
	$I_L = 50\text{mA}$	140		190	
	$I_L = 120\text{mA}$	190		260	
Quiescent Current (I_{GND})	$V_{ENABLE} \leq 0.6\text{V}$ $V_{ENABLE} \leq 0.25\text{V}$	< 1		1 5	μA
Ground Pin Current (I_{GND})	$I_L = 100\mu\text{A}$	80		125	μA
	$I_L = 50\text{mA}$	350		600	
	$I_L = 120\text{mA}$	950		1600	
Ripple Rejection (PSRR)		55			dB
Current Limit (I_{LIMIT})	$V_{OUT} = 0\text{V}$	360	320		mA
Output Noise (e_{NO})	$I_L = 50\text{mA}$, $C_L = 1.0\mu\text{F}$ (10Hz – 100KHz)	390			μVRMS
Input Voltage Level Logic Low (V_{IL})	OFF			0.6	V
Input Voltage Level Logic High (V_{IH})	ON		2.0		
ENABLE Input Current	$V_{IL} \leq 0.6\text{V}$	0.01		2	μA
	$V_{IH} \geq 2.0\text{V}$	2		20	

Note 1: The maximum allowable power dissipation is a function of maximum operating junction temperature, $T_{J(max)}$, the junction to ambient thermal resistance, and the ambient, θ_{JA} , and the ambient temperature T_A . The maximum allowable power dissipation at any ambient temperature is given:

$P_{D(max)} = (T_{J(max)} - T_A) \theta_{JA}$. Exceeding the maximum allowable power limit will result in excessive die temperature; thus, the regulator will go into thermal shutdown.

The θ_{JA} of the SPX8863 is 220°C/W mounted on a PC board.

Note 2: Not apply to 1.8V version.

TYPICAL APPLICATION

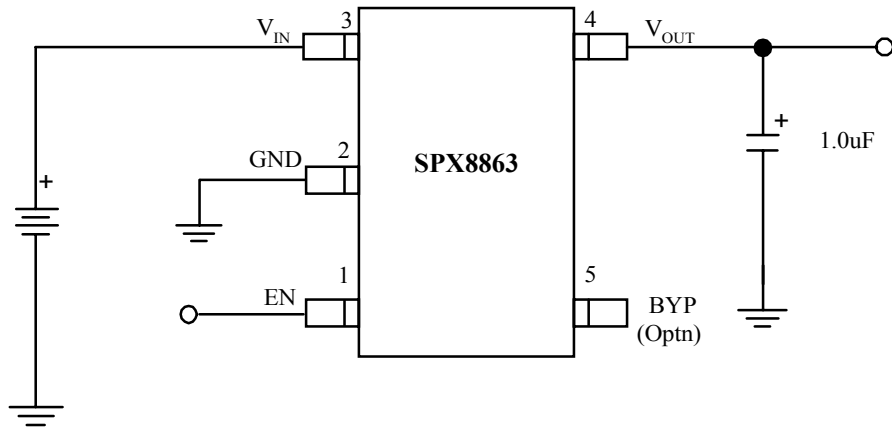

ENABLE may be tied directly to V_{IN}

Application Hints

The SPX8863 requires an output capacitor for device stability. The value required varies greatly depending upon the application circuit and other factors. The high frequency characteristics of electrolytic capacitors depend greatly on the type and also on the manufacturer. Sometimes bench testing is the only means to determine the proper capacitor type and value. The high quality 2.2μF aluminum electrolytic capacitor covers all general application circuits, this stability can be obtained with a tantalum electrolytic value of 1μF.

In general, linear regulator stability decreases with higher output currents. In some applications the SPX8863 may operate at few milliamps. In these applications the output capacitance can be further reduced. For example, when the regulator is running at 10mA output current the output capacitance value is half compared to the same regulator that is running at 150mA.

With the SPX8863 adjustable regulator, the minimum value of output capacitance is a function of the output voltage. The value decreases with higher output voltages, since the closed loop gain is increased.

Typical Applications Circuits

The SPX8863 provides access to the internal reference. A 10μF capacitor on the BYP pin will provide a significant reduction in output noise. This pin may be left unconnected if the output noise is not a major concern. The SPX8863 start-up speed is inversely proportional to the size of its capacitor. Applications requiring a slow ramp-up of output voltage should consider larger values of C_{BYP}. If the rapid turn-ON is necessary, omit bypass capacitor.

Figure 1 shows SPX8863 standard application circuit. The EN (enable) pin is pulled high (>2.0V) to enable the regulator. To disable the regulator, EN < 0.6V.

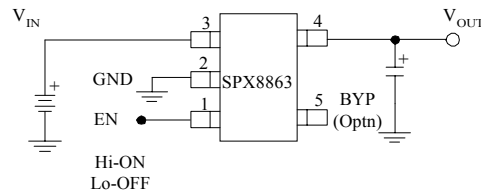

Top View

Fig. 1

The SPX8863 in figure 2 shows adjustable output voltage configuration. Two resistors set the output voltage. The formula for output voltage is:

$$V_{OUT} = 1.235V \times \left(1 + \frac{R1}{R2}\right)$$

Resistor values are not critical as the Adj. pin has high input impedance, for best results use resistors of 47kΩ or less. A capacitor for Adj to ground will provide improved noise performance.

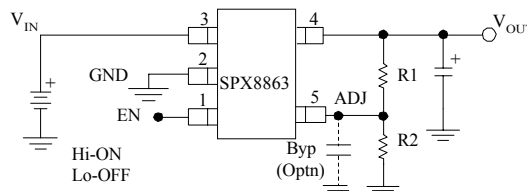

Top View

Fig. 2

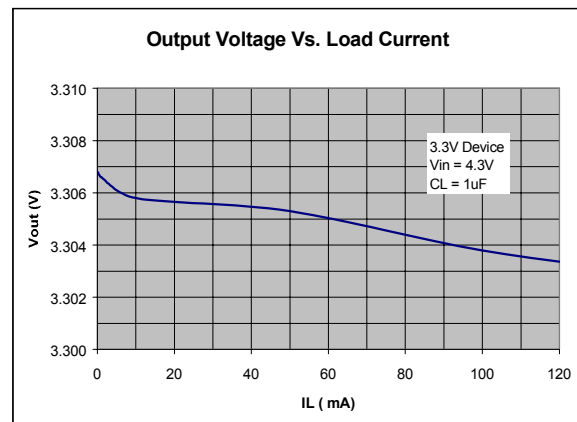
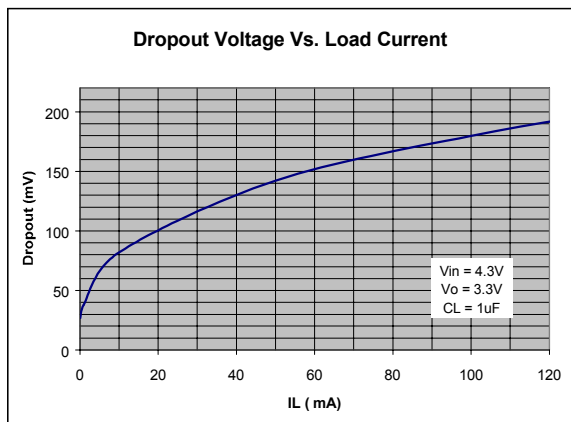
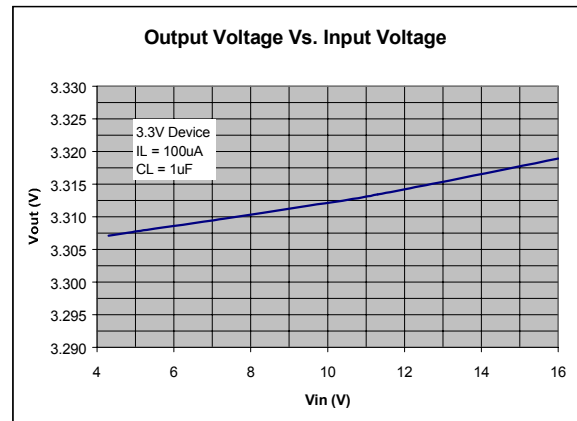
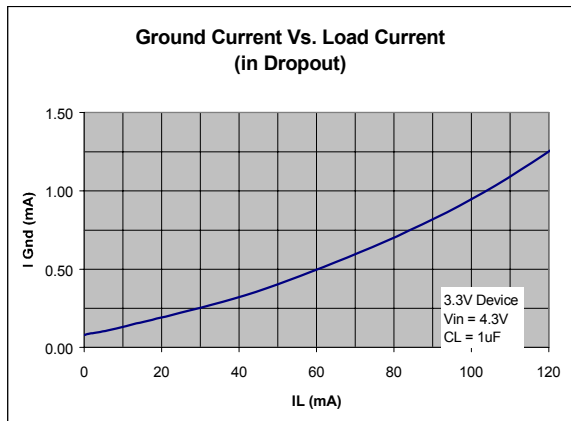
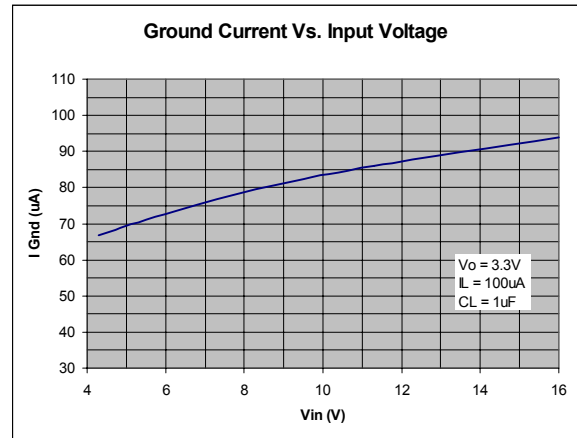
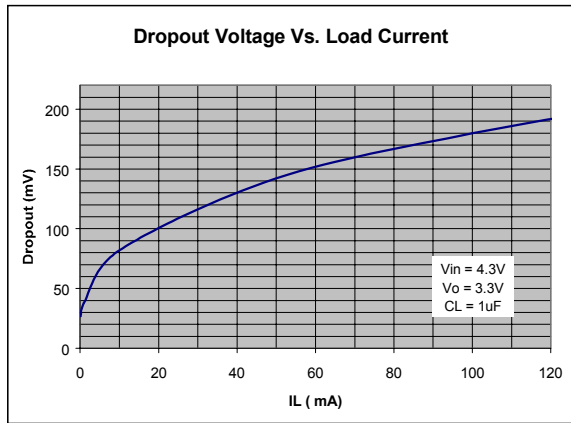

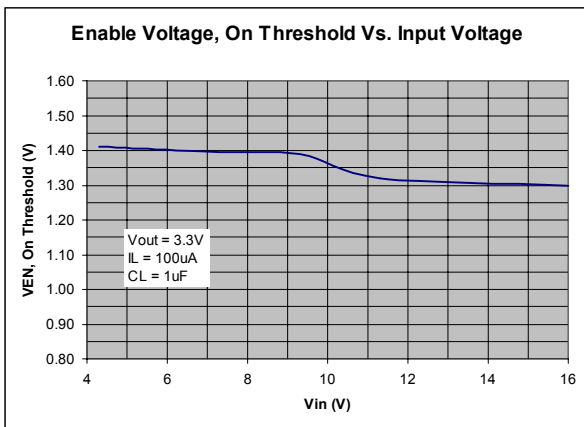
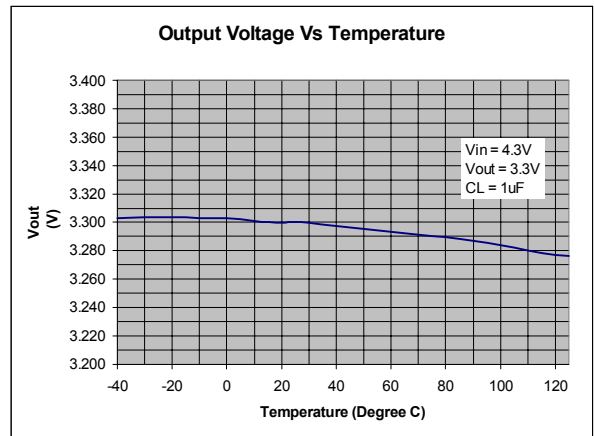
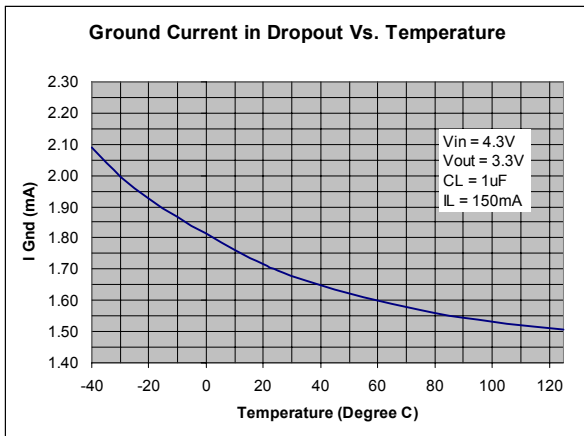
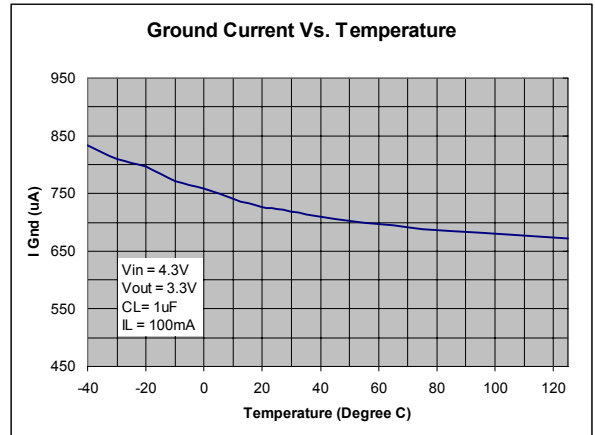
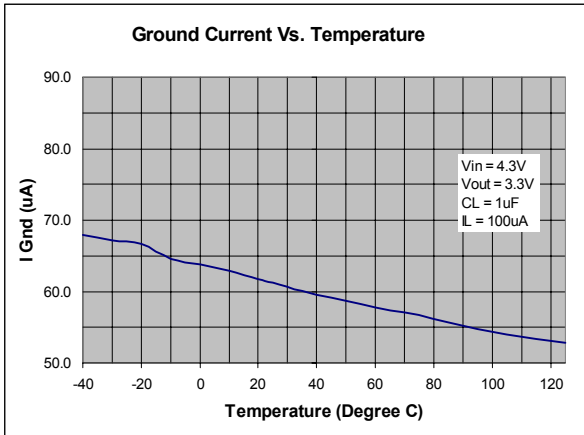

Line Transient Response

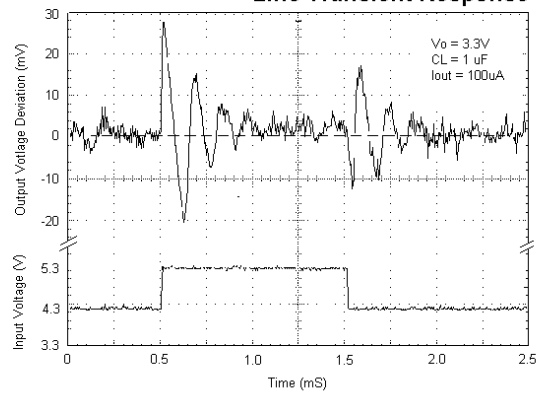

Load Transient Response

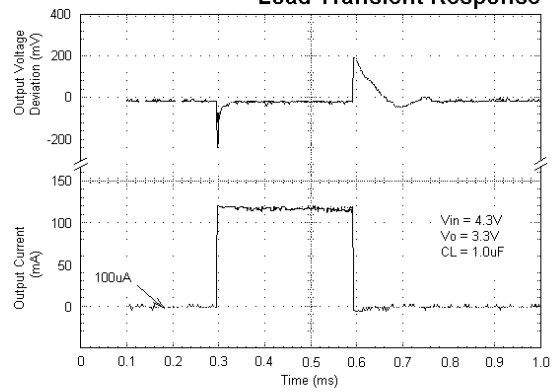

Switching Characteristics

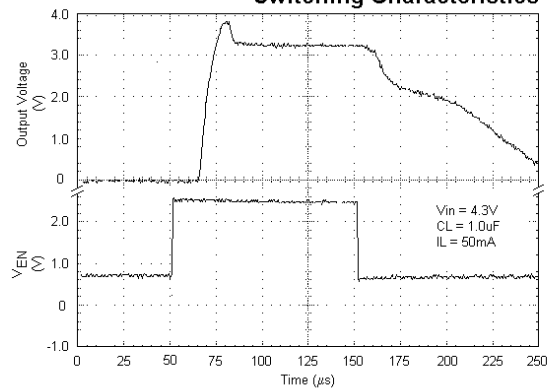

PACKAGE DRAWING
SOT-23-5L (M5)

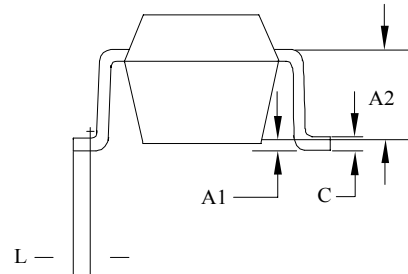
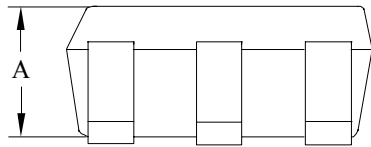
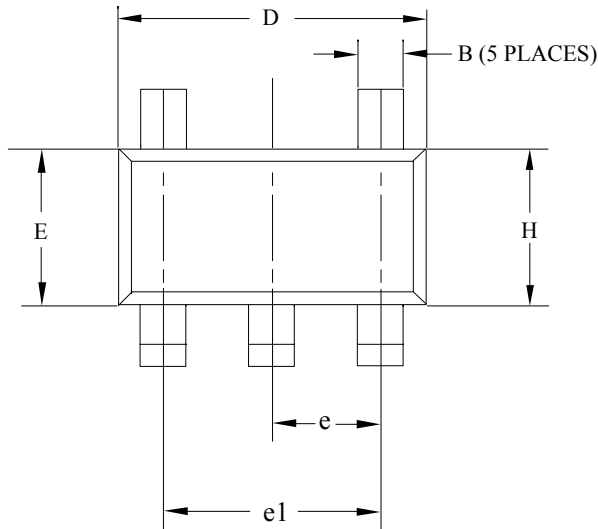

SYMBOL	MILLIMETERS		INCHES	
	MIN.	MAX.	MIN.	MAX.
A	0.90	1.30	.035	.051
A1	0	0.10	0	.004
A2	0.80 REF		.0315 REF	
B	0.30	0.50	.012	.019
C	0.10	0.35	.004	.0137
D	2.70	3.10	.106	.122
E	1.40	1.80	.055	.071
e	0.95 BSC.		.037 BSC.	
e1	1.70	2.10	.066	.082
H	2.50	3.00	.098	.118
L	MIN 0.2		MIN .0078	

NOTE:

1. REFER TO APPLICABLE
2. CONTROLLING DIMENTION : MILLIMETER
3. PACKAGE SURFACE FINISHING TO BE SMOOTH FINISH.

ORDERING INFORMATION

Ordering No.	Output Voltage	Packages
SPX8863M5	Adj	5 Lead SOT-23
SPX8863M5-1.8	1.5V	5 Lead SOT-23
SPX8863M5-2.5	2.5V	5 Lead SOT-23
SPX8863M5-2.8	2.8V	5 Lead SOT-23
SPX8863M5-3.0	3.0V	5 Lead SOT-23
SPX8863M5-3.3	3.3V	5 Lead SOT-23
SPX8863M5-4.0	4.0V	5 Lead SOT-23
SPX8863M5-4.5	4.5V	5 Lead SOT-23
SPX8863M5-5.0	5.0V	5 Lead SOT-23



SIGNAL PROCESSING EXCELLENCE

Sipex Corporation

Headquarters and Main Offices:

22 Linnell Circle
Billerica, MA 01821
TEL: (978) 667-8700
FAX: (978) 670-9001
e-mail: sales@sipex.com

233 South Hillview Drive
Milpitas, CA 95035
TEL: (408) 935-7600
FAX: (408) 934-7500

Sipex Corporation reserves the right to make changes to any products described herein. Sipex does not assume any liability arising out of the application or use of any product or circuit described herein; neither does it convey any license under its patent rights nor the rights of others.