



LC75750E, 75750W

1/3 Duty VFD Driver



Overview

The LC75750E and LC75750W are 1/3 duty VFD drivers that can be used for electronic tuning frequency display and other applications under the control of a micro-controller. These products can directly drive VFDs with up to 264 segments.

Features

- 264 segment outputs.
- Noise reduction circuits are built into the output drivers.
- Serial data input supports CCB format communication with the system controller.
- Dimmer can be controlled by serial data input.
- High generality since display data is displayed without the intervention of a decoder.
- All segments can be turned off with the $\overline{\text{BLK}}$ pin.

Package Dimensions

unit: mm

3151-QFP100E

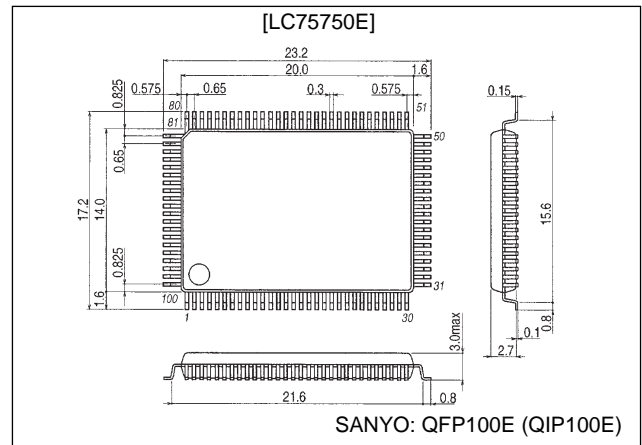

unit: mm

3181B-SQFP100

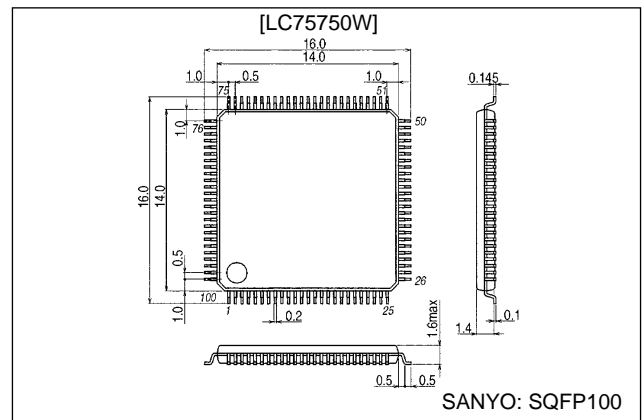

- CCB is a trademark of SANYO ELECTRIC CO., LTD.
- CCB is SANYO's original bus format and all the bus addresses are controlled by SANYO.

■ Any and all SANYO products described or contained herein do not have specifications that can handle applications that require extremely high levels of reliability, such as life-support systems, aircraft's control systems, or other applications whose failure can be reasonably expected to result in serious physical and/or material damage. Consult with your SANYO representative nearest you before using any SANYO products described or contained herein in such applications.

■ SANYO assumes no responsibility for equipment failures that result from using products at values that exceed, even momentarily, rated values (such as maximum ratings, operating condition ranges, or other parameters) listed in products specifications of any and all SANYO products described or contained herein.

LC75750E, 75750W

Specifications

Absolute Maximum Ratings at $T_a = 25^\circ\text{C}$, $V_{SS} = 0\text{V}$

Parameter	Symbol	Conditions	Ratings	Unit
Maximum supply voltage	$V_{DD\text{ max}}$	V_{DD}	-0.3 to +6.5	V
	$V_{FL\text{ max}}$	V_{FL}	-0.3 to +21.0	V
Input voltage	V_{IN1}	DI, CL, CE, $\overline{\text{BLK}}$	-0.3 to +6.5	V
	V_{IN2}	OSCI	-0.3 to $V_{DD} + 0.3$	V
Output voltage	V_{OUT1}	S1 to S88, G1 to G3	-0.3 to $V_{FL} + 0.3$	V
	V_{OUT2}	OSCO	-0.3 to $V_{DD} + 0.3$	V
Output current	I_{OUT1}	S1 to S88	6	mA
	I_{OUT2}	G1 to G3	60	mA
Allowable power dissipation	$P_{d\text{ max}}$	$T_a = 85^\circ\text{C}$ (LC75750E)	500	nW
		$T_a = 85^\circ\text{C}$ (LC75750W)	450	mW
Operating temperature	T_{opr}		-40 to +85	$^\circ\text{C}$
Storage temperature	T_{stg}		-50 to +150	$^\circ\text{C}$

Allowable Operating Ranges at $T_a = -40$ to $+85^\circ\text{C}$, $V_{DD} = 4.5$ to 5.5V , $V_{SS} = 0\text{V}$

Parameter	Symbol	Conditions	Ratings			Unit
			min	typ	max	
Supply voltage	V_{DD}	V_{DD}	4.5	5.0	5.5	V
	V_{FL}	V_{FL}	8	12	18	V
Input high-level voltage	V_{IH1}	DI, CI, CE, $\overline{\text{BLK}}$	$0.8 V_{DD}$		5.5	V
	V_{IH2}	OSCI	$0.8 V_{DD}$		V_{DD}	V
Input low-level voltage	V_{IL}	DI, CL, CE, $\overline{\text{BLK}}$, OSCI	0		$0.2 V_{DD}$	V
Guaranteed oscillator range	f_{OSC}	OSCI, OSCO	0.9	2.4	3.7	MHz
Recommended external resistance	R_{OSC}	OSCI, OSCO	2.2	12	47	$\text{k}\Omega$
Recommended external capacitance	C_{OSC}	OSCI, OSCO	15	33	100	pF
Low level clock pulse width	$t_{\phi L}$	CL : Figure 1	160			ns
High level clock pulse width	$t_{\phi H}$	CL : Figure 1	160			ns
Data setup time	t_{ds}	DI, CL : Figure 1	160			ns
Data hold time	t_{dh}	DI, CL : Figure 1	160			ns
CE wait time	t_{cp}	CE, CL : Figure 1	160			ns
CE setup time	t_{cs}	CE, CL : Figure 1	160			ns
CE hold time	t_{ch}	CE, CL : Figure 1	160			ns
$\overline{\text{BLK}}$ switching time	t_c	$\overline{\text{BLK}}$, CE : Figure 3	10			μs

Electrical Characteristics in the Allowable Operating Ranges

Parameter	Symbol	Conditions	Ratings			Unit
			min	typ	max	
Input high-level current	I_{IH1}	DI, CL, CE, $\overline{\text{BLK}}$: $V_{IN} = 5.5\text{V}$			5	μA
	I_{IH2}	OSCI : $V_{IN} = V_{DD}$			5	μA
Input low-level current	I_{IL}	DI, CL, CE, $\overline{\text{BLK}}$, OSCI : $V_{IN} = 0\text{V}$	-5			μA
Output high-level voltage	V_{OH1}	S1 to S88 : $I_O = -2\text{ mA}$	$V_{FL} - 0.6$			V
	V_{OH2}	G1 to G3 : $I_O = -50\text{ mA}$	$V_{FL} - 1.3$			V
	V_{OH3}	OSCO : $I_O = -0.5\text{ mA}$	$V_{DD} - 2.0$			V
Output low-level voltage	V_{OL1}	S1 to S88, G1 to G3 : $I_O = 50\text{ }\mu\text{A}$			0.5	V
	V_{OL2}	OSCO : $I_O = 0.5\text{ mA}$			2.0	V
Oscillator frequency	f_{OSC}	$R_{OSC} = 12\text{ k}\Omega$, $C_{OSC} = 33\text{ pF}$		2.4		MHz
Hysteresis voltage	V_H	DI, CL, CE, $\overline{\text{BLK}}$		$0.1 V_{DD}$		V
Current drain	I_{DD}	Outputs open : $f_{OSC} = 2.4\text{ MHz}$			10	mA

- When CL is stopped at the low level

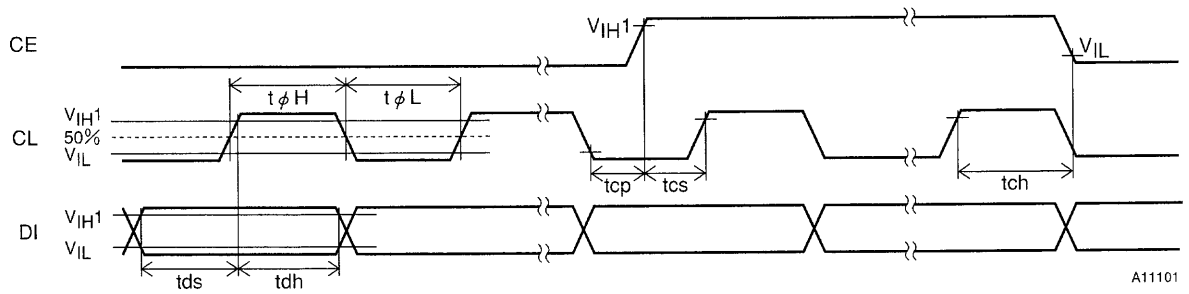

- When CL is stopped at the high level

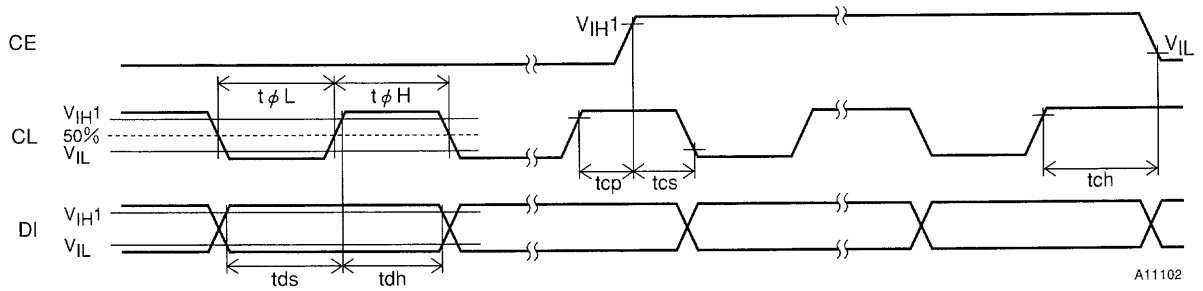
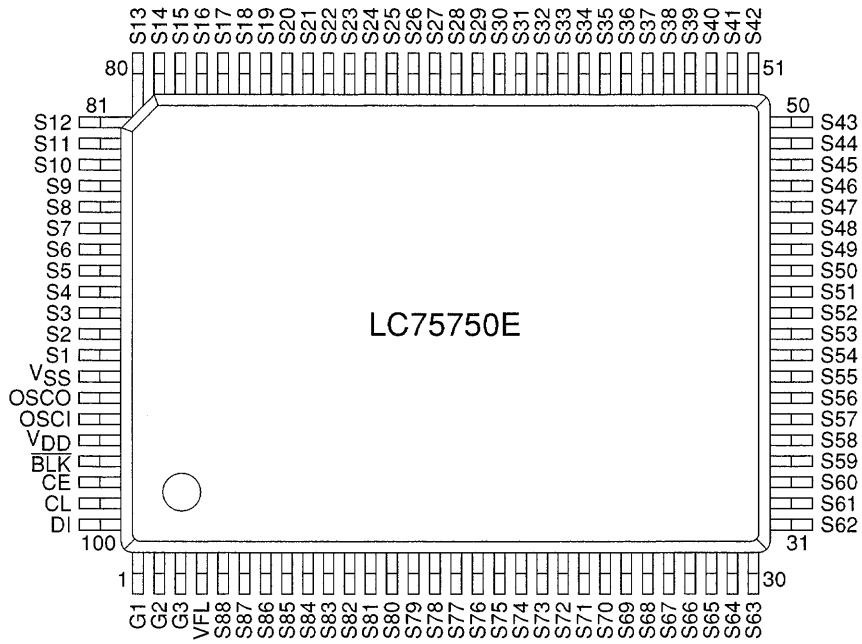

Figure 1

LC75750E, 75750W

Pin Assignment (Top view)



A11057

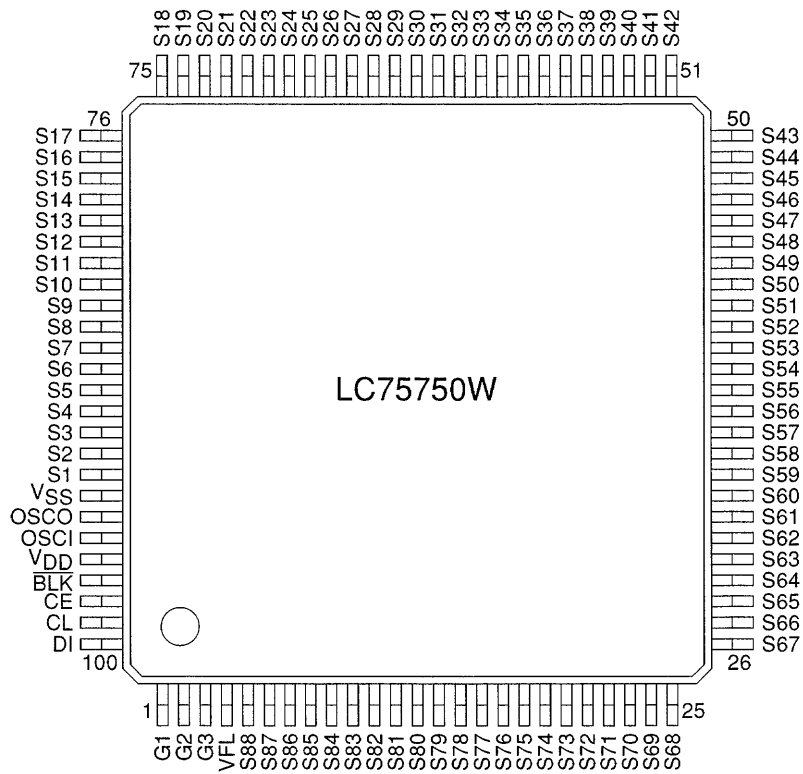

A11058

Block Diagram

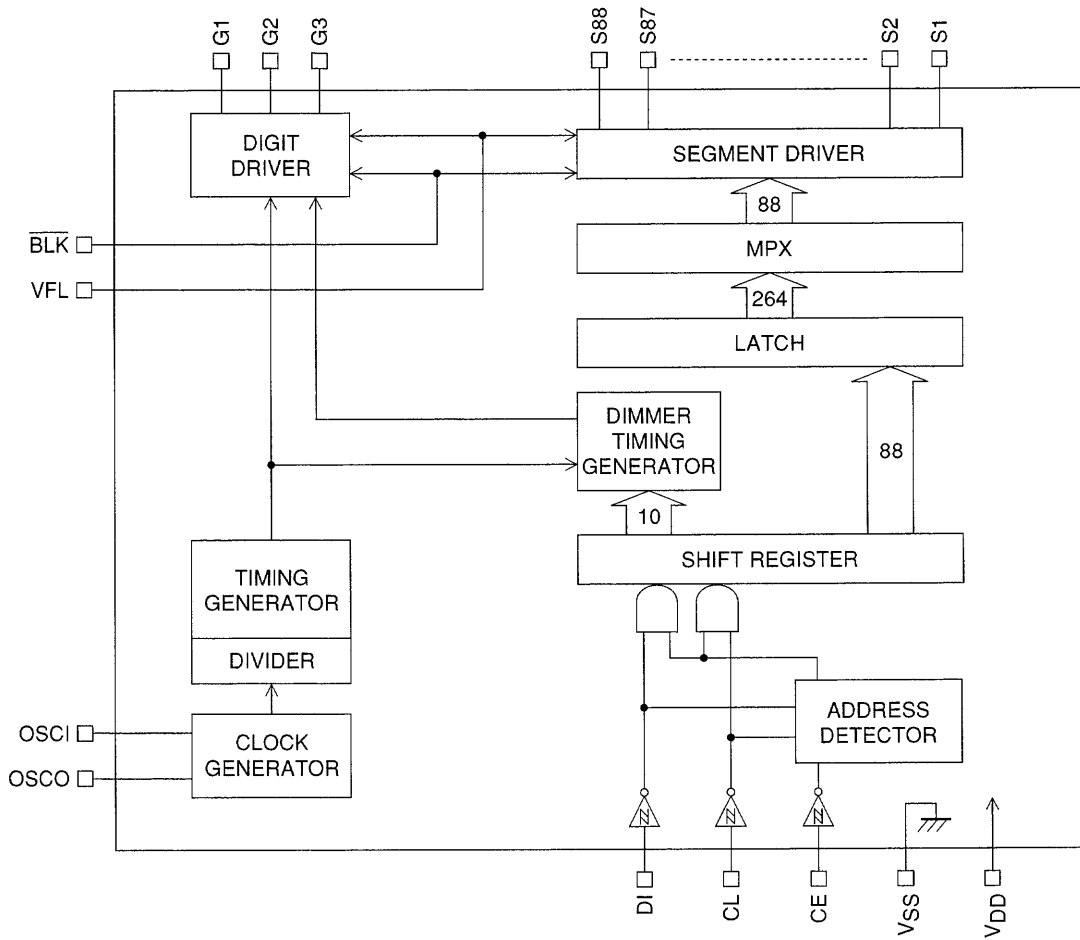

A11059

Pin Functions

Pin No.	Pin	Function	I/O	Handling when unused
4	V _{FL}	Driver block power supply. A voltage of between 8.0 and 18.0 V must be supplied.	—	—
96	V _{DD}	Logic block power supply. A voltage of between 4.5 and 5.5 V must be supplied.	—	—
93	V _{SS}	Power supply. Must be connected to the system ground.	—	—
95	OSCI	Oscillator connection. An oscillator circuit is formed by connecting an external resistor and capacitor to these pins.	I	GND
94	OSCO		O	OPEN
97	BLK	Display off control input. BLK = L (V _{SS})Display off (S1 to S24, G1 to G3 = L) BLK = H (V _{DD})Display on Note that serial data can be transferred while the display is turned off.	I	GND
99	CL	Serial data transfer inputs. These pins must be connected to the system microcontroller. CL : Synchronization clock DI : Transfer data CE : Chip enable	I	GND
100	DI			
98	CE			
1 to 3	G1 to G3	Digit outputs. The frame frequency f _o is (f _{OSC} /6144)Hz.	O	OPEN
92 to 5	S1 to S88	Segment outputs for displaying the display data transferred by serial data input	O	OPEN

Serial Data Transfer Format

- When CL is stopped at the low level

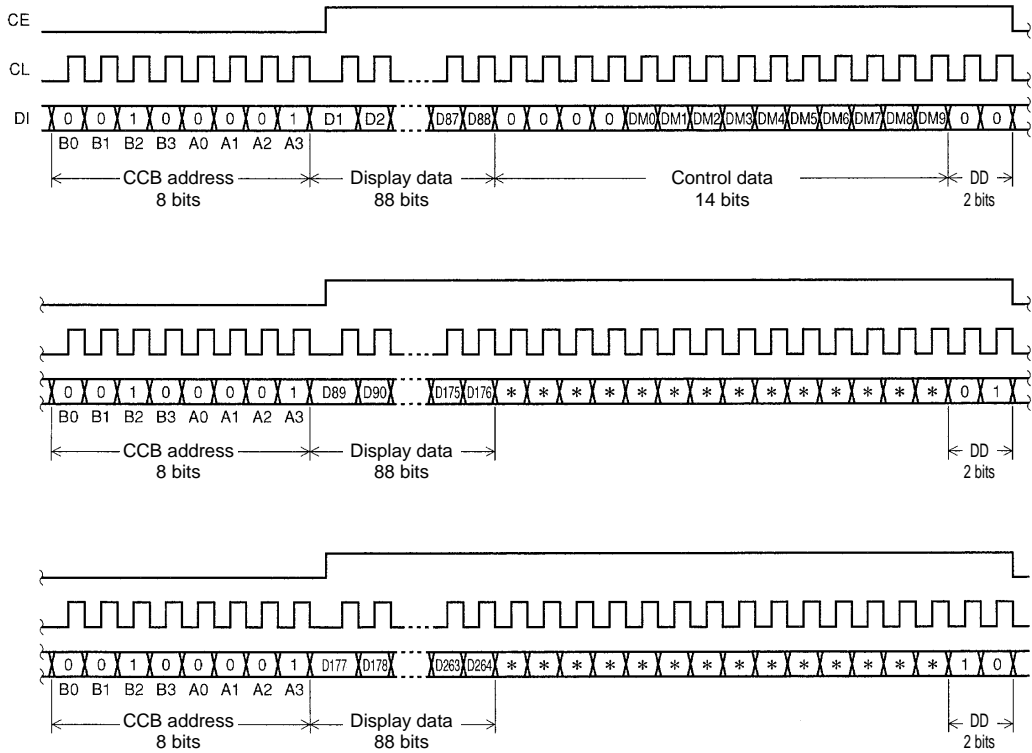

* : don't care
DD : direction data

A11060

- When CL is stopped at the high level

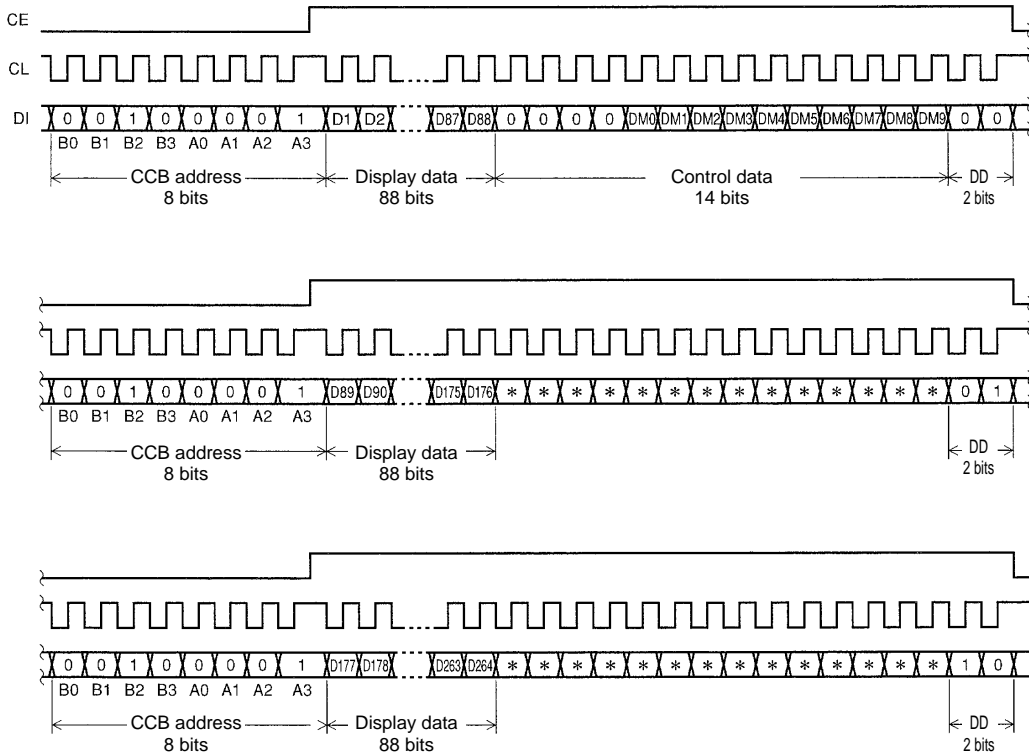

* : don't care
DD : direction data

A11061

Figure 2

LC75750E, 75750W

CCB address : Transfer 00100001B (84_H) as shown in Figure 2

DM0 to DM9 : Dimmer data

This data controls the duty of the G1 to G3 digit output pins, and consists of 10 bits with DM0 being the LSB. Note that the intensity of the display can be adjusted by controlling the duty of the G1 to G3 digit output pins.

The relationship between the dimmer data and the dimmer value is as follows.

DM9	DM8	DM7	DM6	DM5	DM4	DM3	DM2	DM1	DM0	Dimmer value (t4/t3)
0	0	0	0	0	0	0	0	0	0	0/1024
0	0	0	0	0	0	0	0	0	1	1/1024
0	0	0	0	0	0	0	0	1	0	2/1024
					⋮					⋮
1	1	1	1	1	1	1	1	0	0	1020/1024
1	1	1	1	1	1	1	1	0	1	1021/1024
1	1	1	1	1	1	1	1	1	0	1022/1024
1	1	1	1	1	1	1	1	1	1	Not used

t3, t4 : See Figure 4.

D1 to D88 : Display data for the G1 digit output pin.

Dn (n = 1 to 88) = 1 : On

Dn (n = 1 to 88) = 0 : Off

D89 to D176 : Display data for the G2 digit output pin.

Dn (n = 89 to 176) = 1 : On

Dn (n = 89 to 176) = 0 : Off

D177 to D264 : Display data for the G3 digit output pin.

Dn (n = 177 to 264) = 1 : On

Dn (n = 177 to 264) = 0 : Off

LC75750E, 75750W

Correspondence between Display Data (D1 to D264) and Segment Output Pins

Segment output pins	G1	G2	G3	Segment output pins	G1	G2	G3	Segment output pins	G1	G2	G3
S1	D1	D89	D177	S31	D31	D119	D207	S61	D61	D149	D237
S2	D2	D90	D178	S32	D32	D120	D208	S62	D62	D150	D238
S3	D3	D91	D179	S33	D33	D121	D209	S63	D63	D151	D239
S4	D4	D92	D180	S34	D34	D122	D210	S64	D64	D152	D240
S5	D5	D93	D181	S35	D35	D123	D211	S65	D65	D153	D241
S6	D6	D94	D182	S36	D36	D124	D212	S66	D66	D154	D242
S7	D7	D95	D183	S37	D37	D125	D213	S67	D67	D155	D243
S8	D8	D96	D184	S38	D38	D126	D214	S68	D68	D156	D244
S9	D9	D97	D185	S39	D39	D127	D215	S69	D69	D157	D245
S10	D10	D98	D186	S40	D40	D128	D216	S70	D70	D158	D246
S11	D11	D99	D187	S41	D41	D129	D217	S71	D71	D159	D247
S12	D12	D100	D188	S42	D42	D130	D218	S72	D72	D160	D248
S13	D13	D101	D189	S43	D43	D131	D219	S73	D73	D161	D249
S14	D14	D102	D190	S44	D44	D132	D220	S74	D74	D162	D250
S15	D15	D103	D191	S45	D45	D133	D221	S75	D75	D163	D251
S16	D16	D104	D192	S46	D46	D134	D222	S76	D76	D164	D252
S17	D17	D105	D193	S47	D47	D135	D223	S77	D77	D165	D253
S18	D18	D106	D194	S48	D48	D136	D224	S78	D78	D166	D254
S19	D19	D107	D195	S49	D49	D137	D225	S79	D79	D167	D255
S20	D20	D108	D196	S50	D50	D138	D226	S80	D80	D168	D256
S21	D21	D109	D197	S51	D51	D139	D227	S81	D81	D169	D257
S22	D22	D110	D198	S52	D52	D140	D228	S82	D82	D170	D258
S23	D23	D111	D199	S53	D53	D141	D229	S83	D83	D171	D259
S24	D24	D112	D200	S54	D54	D142	D230	S84	D84	D172	D260
S25	D25	D113	D201	S55	D55	D143	D231	S85	D85	D173	D261
S26	D26	D114	D202	S56	D56	D144	D232	S86	D86	D174	D262
S27	D27	D115	D203	S57	D57	D145	D233	S87	D87	D175	D263
S28	D28	D116	D204	S58	D58	D146	D234	S88	D88	D176	D264
S29	D29	D117	D205	S59	D59	D147	D235				
S30	D30	D118	D206	S60	D60	D148	D236				

Example : Segment output pin S11 is controlled as follows :

Display data			Segment output pin S11 state
D11	D99	D187	
0	0	0	The segments corresponding to the G1, G2, and G3 digit output pins are off
0	0	1	The segments corresponding to the G3 digit output pin are on
0	1	0	The segments corresponding to the G2 digit output pin are on
0	1	1	The segments corresponding to the G2 and G3 digit output pins are on
1	0	0	The segments corresponding to the G1 digit output pin are on
1	0	1	The segments corresponding to the G1 and G3 digit output pins are on
1	1	0	The segments corresponding to the G1 and G2 digit output pins are on
1	1	1	The segments corresponding to the G1, G2, and G3 digit output pins are on

BLK and the Display Control

Since the IC internal data (D1 to D264 and the control data) is undefined when power is first applied, the display is off (S1 to S88, G1 to G3 = low) by setting the $\overline{\text{BLK}}$ pin low at the same time as power is applied. Then, meaningless display at power on can be prevented by transferring all 336 bits of serial data from the controller and setting $\overline{\text{BLK}}$ pin high after the transfer completes while the display is off. (See Figure 3.)

Power Supply Sequence

The following sequences must be observed when power is turned on and off. (See Figure 3.)

- Power on : Logic block power supply (V_{DD}) on → Driver block power supply (V_{FL}) on
- Power off : Driver block power supply (V_{FL}) off → Logic block power supply (V_{DD}) off

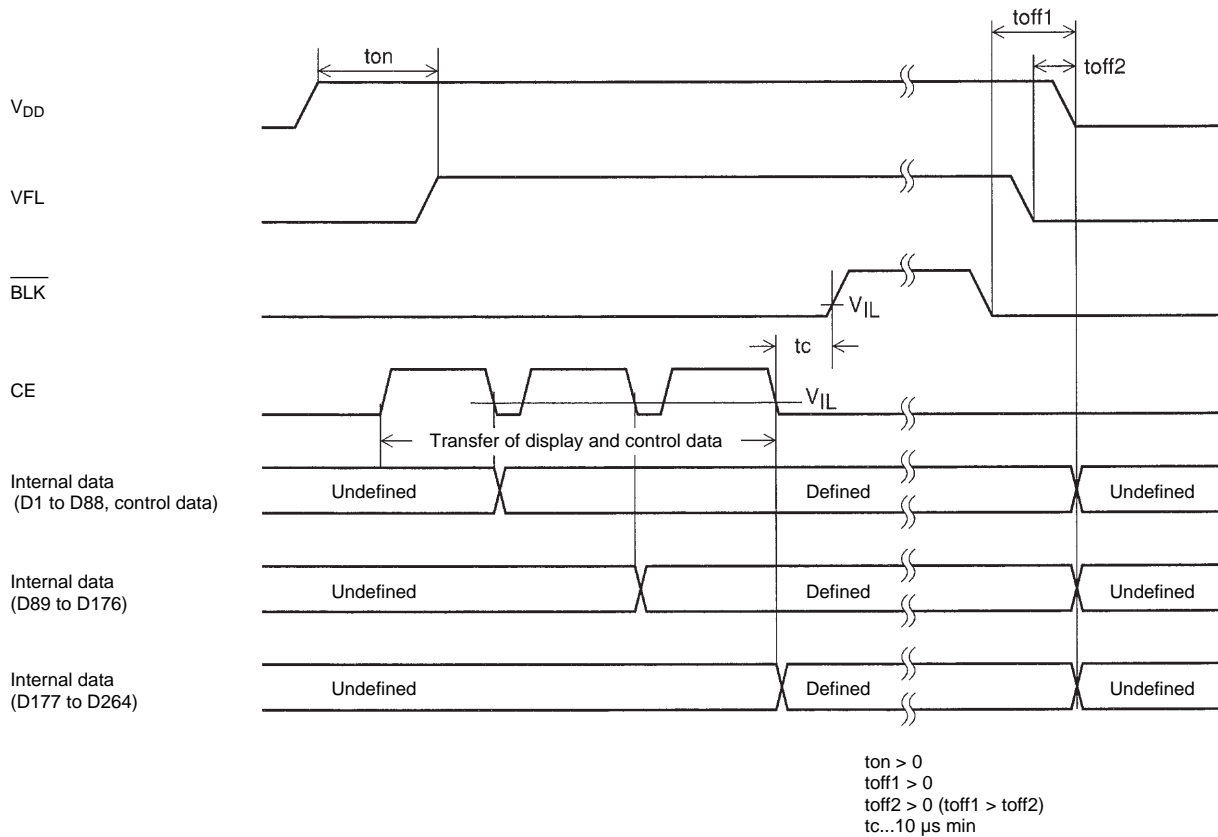
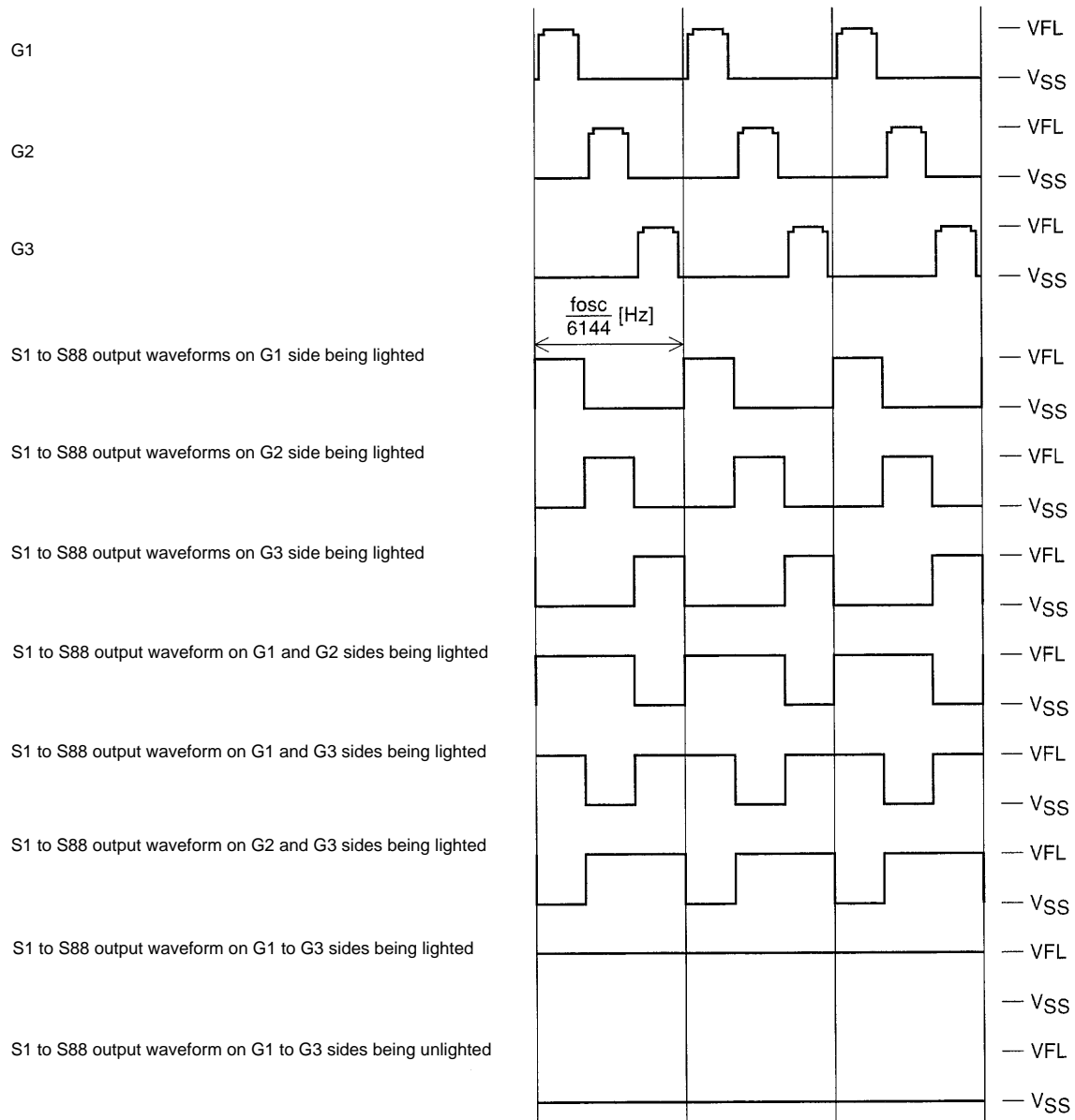

Figure 3

A11062

Output Waveforms (S1 to S88)



A11063

Relationship between Segment and Digit outputs

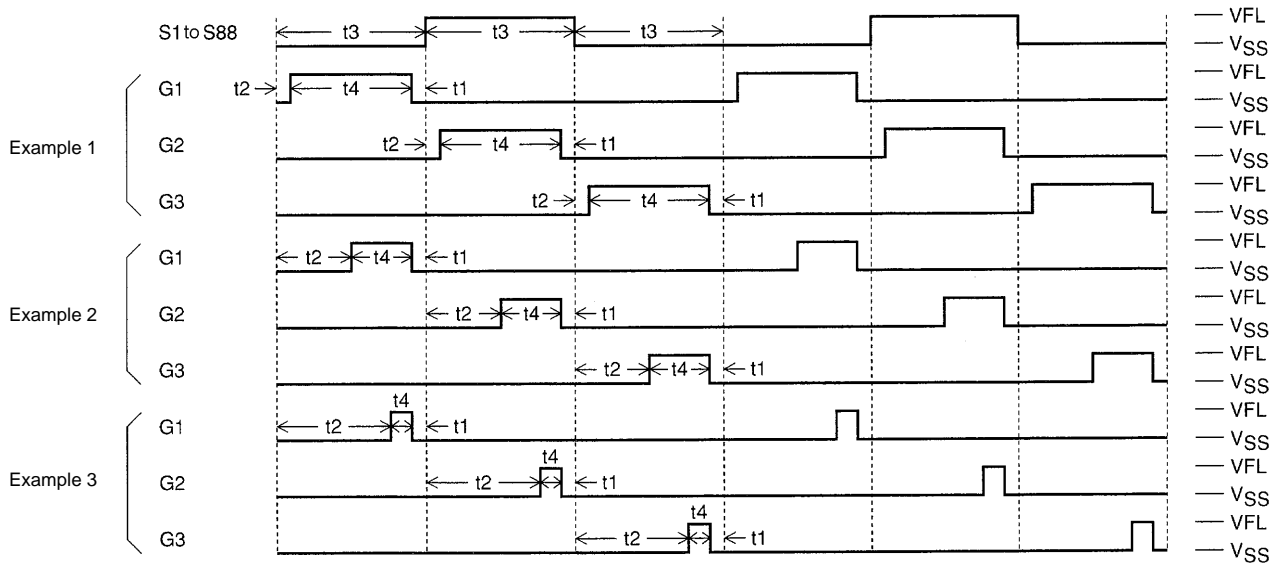

A11064

Figure 4

- Consider the examples shown in Figure 4, where display data is set up so that the segment outputs S1 to S88 output V_{SS} level on the G1 and G3 digit output timing and V_{FL} level on the G2 digit output timing. (Here, the G2 side being lighted) The relationship between the time t_3 and the oscillator frequency f_{OSC} is $t_3 = 2048/f_{OSC}$.
- The digit output G1 to G3 waveforms in Example 1 are output when the dimmer data (DM0 to DM9) are set to 3FEH. The relationship between the time t_1 and the oscillator frequency f_{OSC} is $t_1 = 2/f_{OSC}$. Note that the time t_1 and the time t_2 are the same period in Example 1.
- The digit output G1 to G3 waveforms in Example 2 are those when the dimmer data (DM0 to DM9) are set to a smaller value. Although the time t_1 does not change, the time t_2 becomes longer. When the dimmer data (DM0 to DM9) are set to 1FF_H and the oscillator frequency f_{osc} is 2.4 [MHz], then the time t_2 is :

$$t_2 = t_3 - t_1 \times (1FF_H + 1)$$

$$= \frac{1024}{f_{OSC}}$$

$$= 0.43[\text{ms}]$$

- When the dimmer data (DM0 to DM9) are set to an even smaller value, the time t_2 becomes even longer, as in example 3. Note that the time t_1 does not change here, either.

Sample Application Circuit

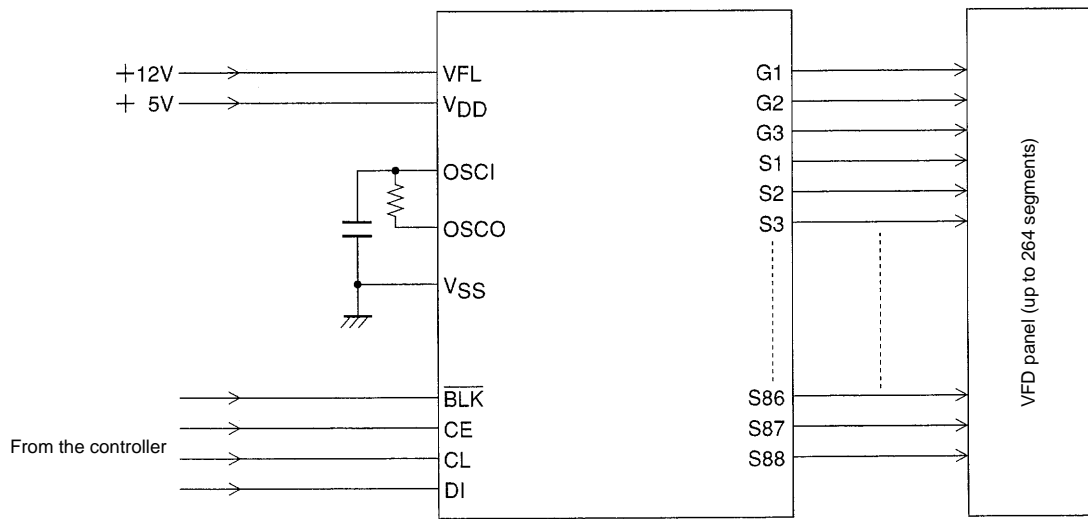

A11065

Notes on the segment and digit waveforms

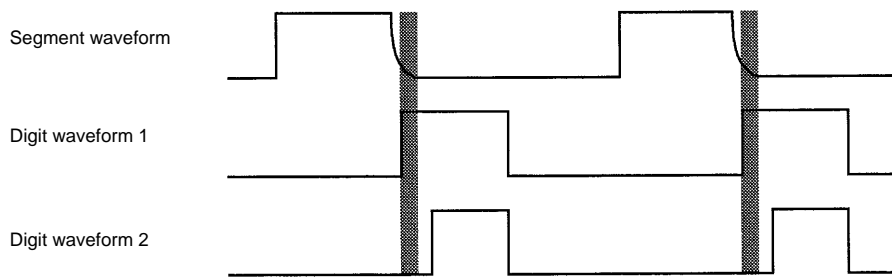

A11066

Figure 5

The segment waveform is distorted by the VFD panel used and the wiring, and furthermore, in the case of being used with essentially no dimming as in the digit waveform 1, as shown in Figure 5, the VFD panel glow dimly. By carefully considering the segment waveform, it can be seen that this problem can be resolved by applying an adequate amount of dimming, as shown in digit waveform 2.

Notes on transferring display data from the controller

Since display data is transferred in three operations as shown in Figure 2, we recommend that all display data be transferred within 30 [ms] to prevent degradation of the visual quality of the displayed image.

- Specifications of any and all SANYO products described or contained herein stipulate the performance, characteristics, and functions of the described products in the independent state, and are not guarantees of the performance, characteristics, and functions of the described products as mounted in the customer's products or equipment. To verify symptoms and states that cannot be evaluated in an independent device, the customer should always evaluate and test devices mounted in the customer's products or equipment.
- SANYO Electric Co., Ltd. strives to supply high-quality high-reliability products. However, any and all semiconductor products fail with some probability. It is possible that these probabilistic failures could give rise to accidents or events that could endanger human lives, that could give rise to smoke or fire, or that could cause damage to other property. When designing equipment, adopt safety measures so that these kinds of accidents or events cannot occur. Such measures include but are not limited to protective circuits and error prevention circuits for safe design, redundant design, and structural design.
- In the event that any or all SANYO products (including technical data, services) described or contained herein are controlled under any of applicable local export control laws and regulations, such products must not be exported without obtaining the export license from the authorities concerned in accordance with the above law.
- No part of this publication may be reproduced or transmitted in any form or by any means, electronic or mechanical, including photocopying and recording, or any information storage or retrieval system, or otherwise, without the prior written permission of SANYO Electric Co., Ltd.
- Any and all information described or contained herein are subject to change without notice due to product/technology improvement, etc. When designing equipment, refer to the "Delivery Specification" for the SANYO product that you intend to use.
- Information (including circuit diagrams and circuit parameters) herein is for example only; it is not guaranteed for volume production. SANYO believes information herein is accurate and reliable, but no guarantees are made or implied regarding its use or any infringements of intellectual property rights or other rights of third parties.

This catalog provides information as of October, 1998. Specifications and information herein are subject to change without notice.