



No.3340

2SA1783/2SC4641

PNP/NPN Epitaxial Planar Silicon Transistors

Low-Frequency General-Purpose Amp Applications

Features

- Capable of being used in the low frequency to high frequency range.

() : 2SA1783

Absolute Maximum Ratings at Ta = 25°C

Parameter	Symbol	Value	unit
Collector to Base Voltage	V _{CB0}	(-)55	V
Collector to Emitter Voltage	V _{CE0}	(-)50	V
Emitter to Base Voltage	V _{EB0}	(-)6	V
Collector Current	I _C	(-)150	mA
Collector Current (Pulse)	I _{CP}	(-)300	mA
Base Current	I _B	(-)30	mA
Collector Dissipation	P _C	500	mW
Junction Temperature	T _J	150	°C
Storage Temperature	T _{stg}	-55 to +150	°C

Electrical Characteristics at Ta = 25°C

Parameter	Symbol	Test Conditions	min	typ	max	unit
Collector Cutoff Current	I _{CB0}	V _{CB} = (-)35V, I _E = 0			(-)0.1	μA
Emitter Cutoff Current	I _{EB0}	V _{EB} = (-)4V, I _C = 0			(-)0.1	μA
DC Current Gain	h _{FE}	V _{CE} = (-)6V, I _C = (-)1mA	140*		560*	
Gain-Bandwidth Product	f _T	V _{CE} = (-)6V, I _C = (-)10mA		200 (180)		MHz
Output Capacitance	c _{ob}	V _{CB} = (-)6V, f = 1MHz		2.2 (3.5)		pF
C-E Saturation Voltage	V _{CE(sat)}	I _C = (-)50mA, I _B = (-)5mA		0.08 (-0.11)	(-)0.4	V
B-E Saturation Voltage	V _{BE(sat)}	I _C = (-)50mA, I _B = (-)5mA		(-)0.8	(-)1.0	V
C-B Breakdown Voltage	V _{(BR)CBO}	I _C = (-)10μA, I _E = 0	(-)55			V
C-E Breakdown Voltage	V _{(BR)CEO}	I _C = (-)1mA, R _{BE} = ∞	(-)50			V
E-B Breakdown Voltage	V _{(BR)EBO}	I _E = (-)10μA, I _C = 0	(-)6			V
Turn-ON Time	t _{on}	See specified Test Circuit.		0.15		μs
Storage Time	t _{stg}	"		0.75 (0.60)		μs
Fall Time	t _f	"		0.20		μs

* : The 2SA1783/2SC4641 are classified by 1mA h_{FE} as follows :

140	S	280	200	T	400	280	U	560
-----	---	-----	-----	---	-----	-----	---	-----

h_{FE} rank : S, T, U

Switching Time Test Circuit

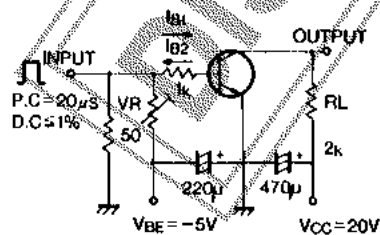

Case Outline 2003A

(unit : mm)

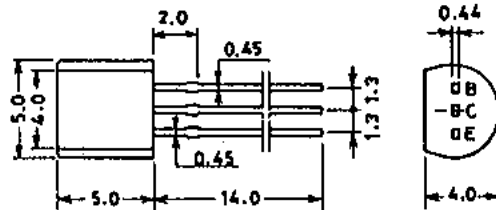

Specifications and information herein are subject to change without notice.

SANYO Electric Co., Ltd. Semiconductor Business Headquarters
TOKYO OFFICE Tokyo Bldg., 1-10, 1 Chome, Ueno, Taito-ku, TOKYO, 110 JAPAN

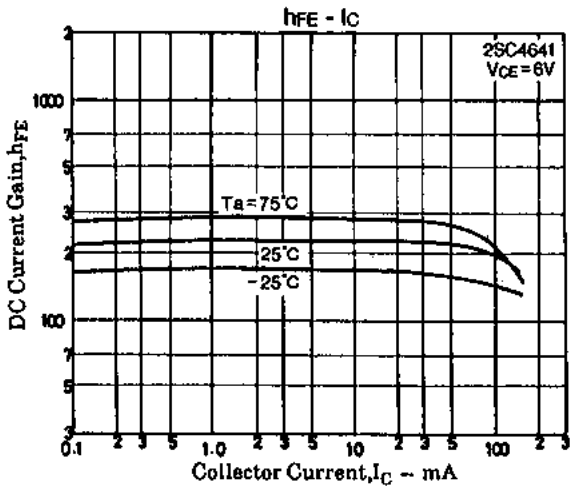
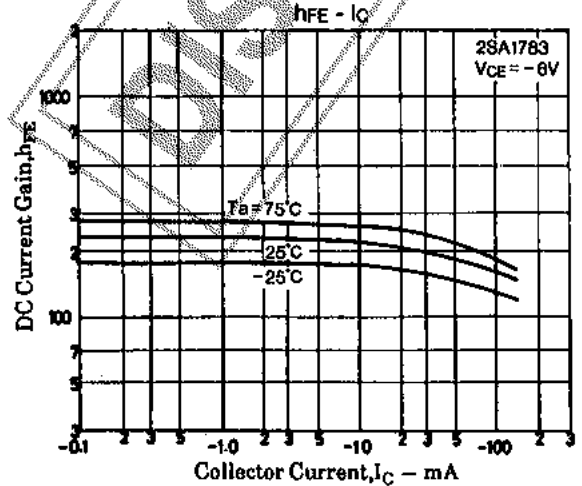
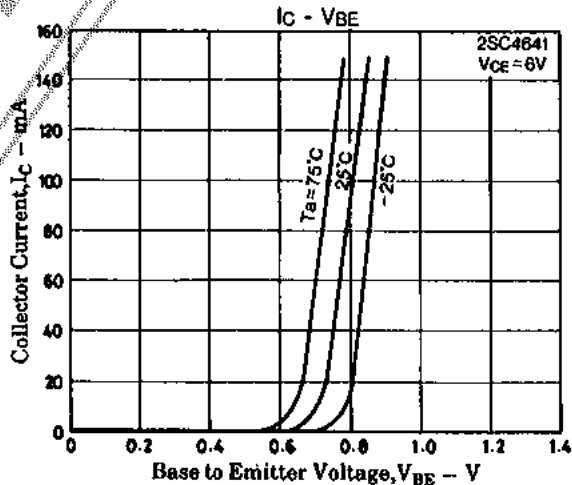
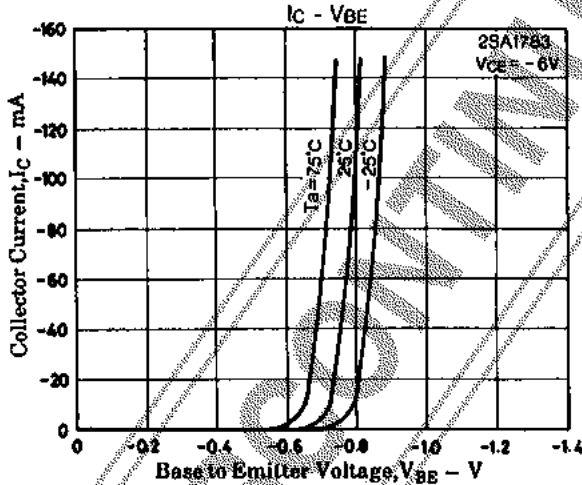
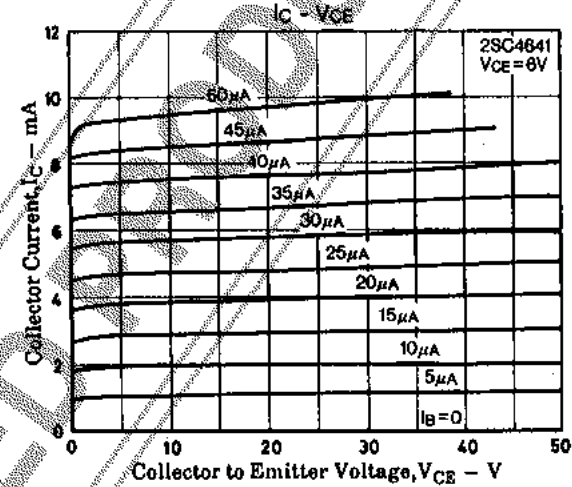
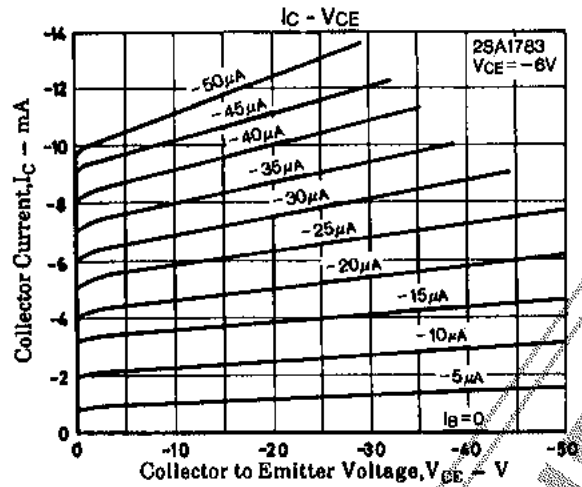
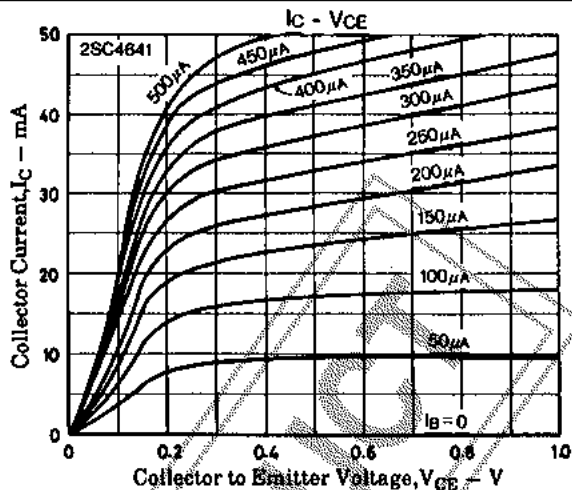
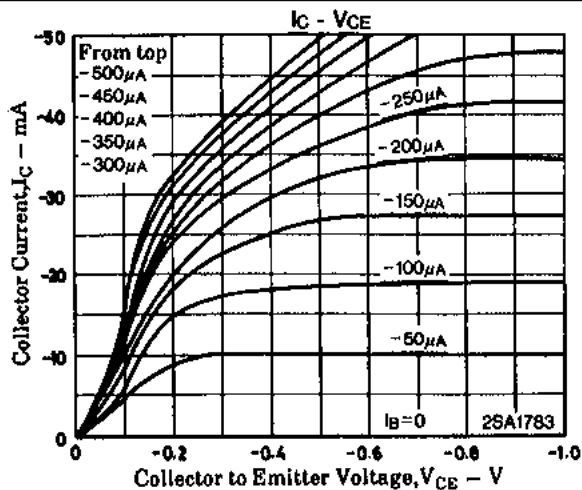

2SA1783/2SC4641

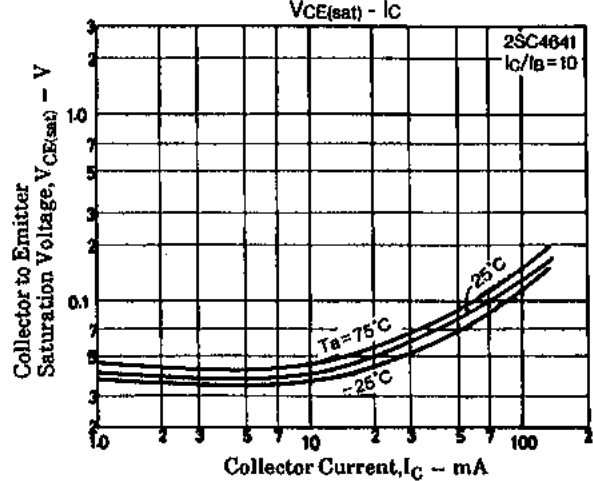
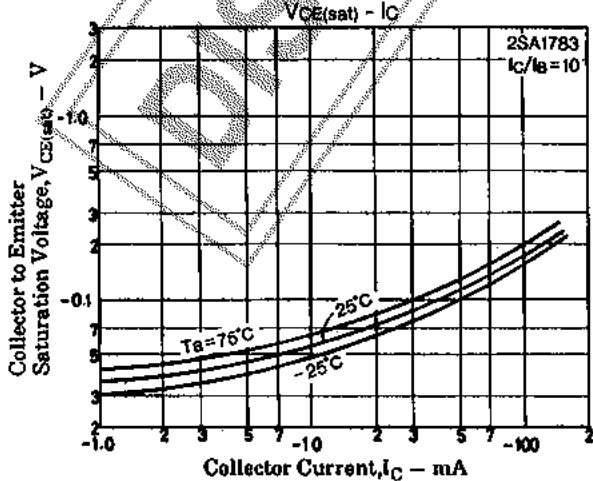
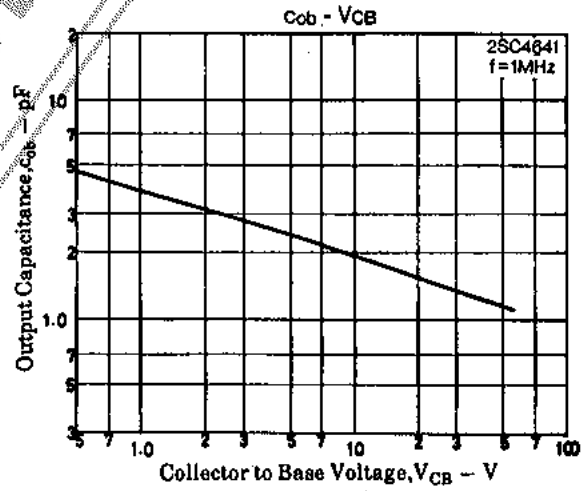
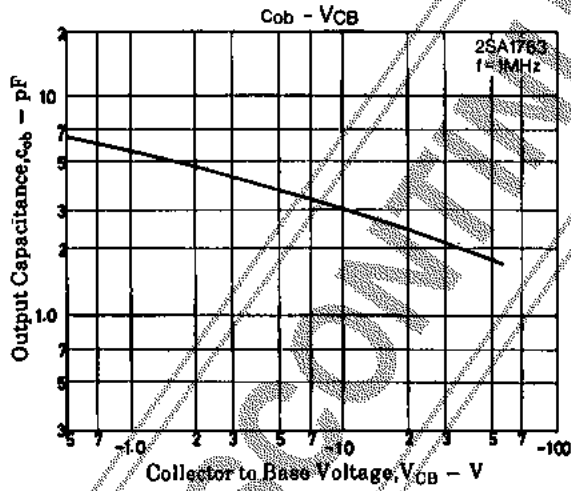
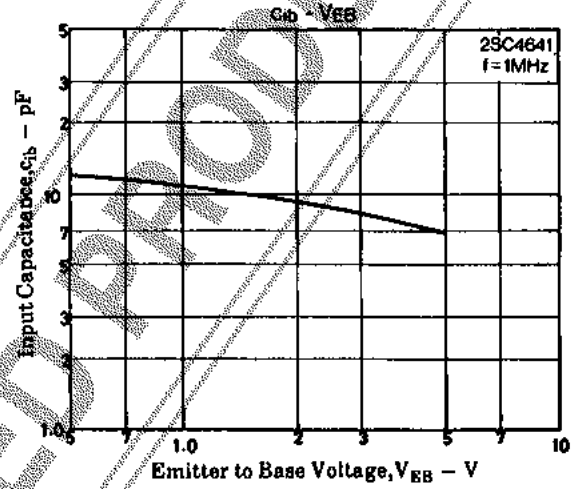
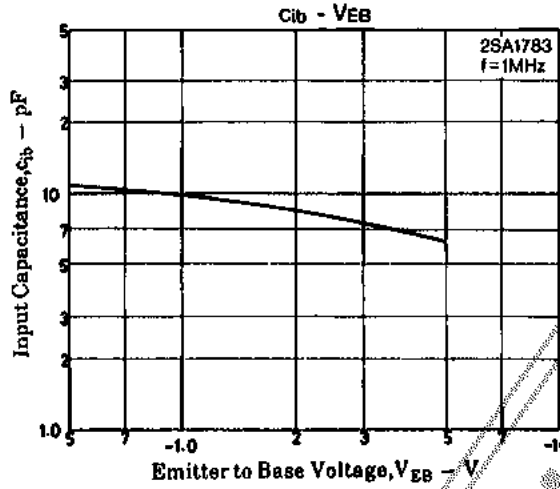
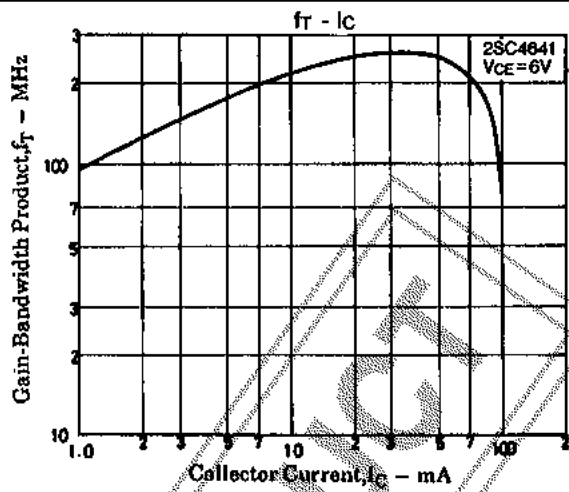
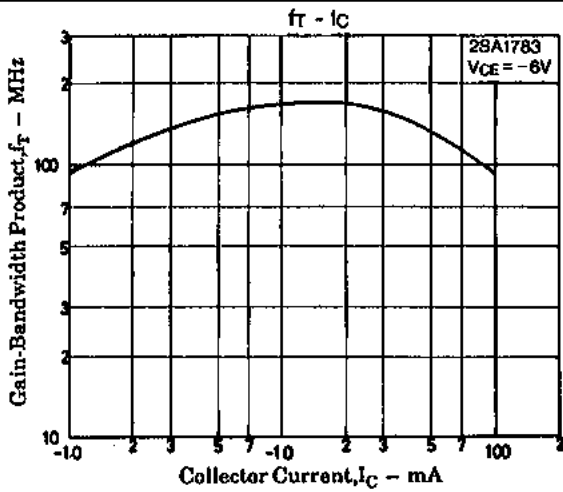

2SA1783/2SC4641

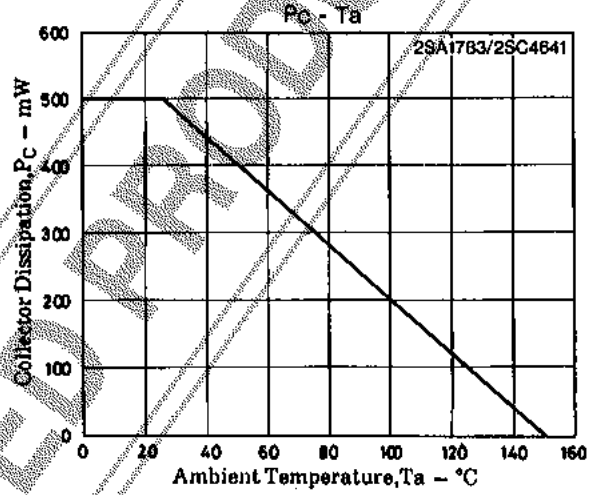
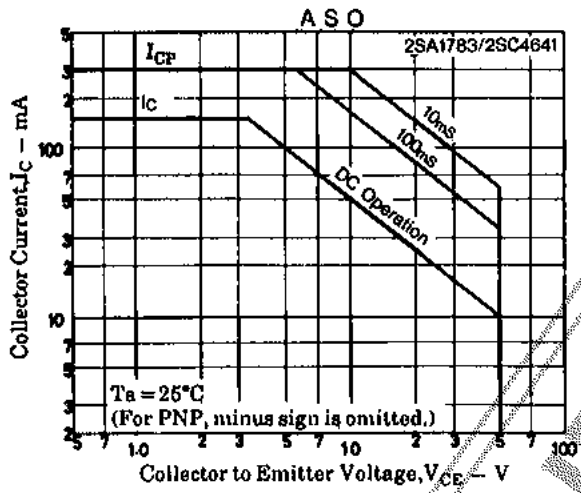
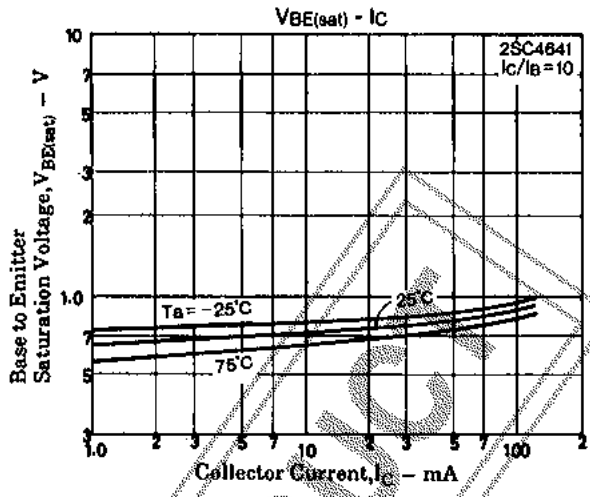
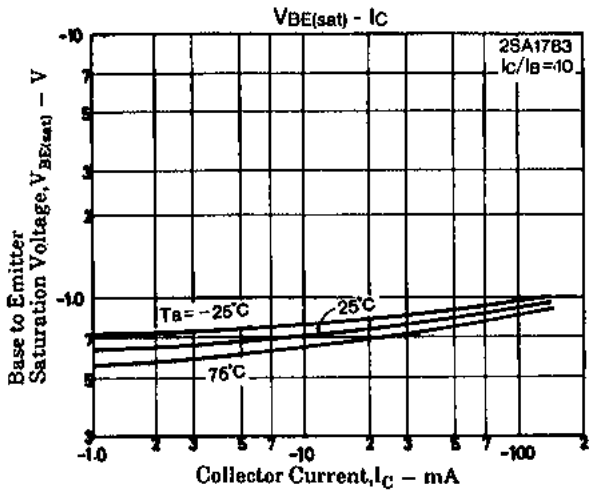

DISCONTINUED